

# PG60 - PG70 - PG81

## *LMV2x Microprocessor-controlled Light oil burners*

**MANUAL OF INSTALLATION - USE - MAINTENANCE**

***CIB UNIGAS***

**BURNERS - BRUCIATORI - BRULERS - BRENNER - QUEMADORES - ГОРЕЛКИ**

## DANGERS, WARNINGS AND NOTES OF CAUTION

**THIS MANUAL IS SUPPLIED AS AN INTEGRAL AND ESSENTIAL PART OF THE PRODUCT AND MUST BE DELIVERED TO THE USER.**

**INFORMATION INCLUDED IN THIS SECTION ARE DEDICATED BOTH TO THE USER AND TO PERSONNEL FOLLOWING PRODUCT INSTALLATION AND MAINTENANCE.**

**THE USER WILL FIND FURTHER INFORMATION ABOUT OPERATING AND USE RESTRICTIONS, IN THE SECOND SECTION OF THIS MANUAL. WE HIGHLY RECOMMEND TO READ IT.**

**CAREFULLY KEEP THIS MANUAL FOR FUTURE REFERENCE.**

### 1) GENERAL INTRODUCTION

- The equipment must be installed in compliance with the regulations in force, following the manufacturer's instructions, by qualified personnel.
- Qualified personnel means those having technical knowledge in the field of components for civil or industrial heating systems, sanitary hot water generation and particularly service centres authorised by the manufacturer.
- Improper installation may cause injury to people and animals, or damage to property, for which the manufacturer cannot be held liable.
- Remove all packaging material and inspect the equipment for integrity. In case of any doubt, do not use the unit - contact the supplier.

The packaging materials (wooden crate, nails, fastening devices, plastic bags, foamed polystyrene, etc), should not be left within the reach of children, as they may prove harmful.

- Before any cleaning or servicing operation, disconnect the unit from the mains by turning the master switch OFF, and/or through the cut-out devices that are provided.
- Make sure that inlet or exhaust grilles are unobstructed.
- In case of breakdown and/or defective unit operation, disconnect the unit. Make no attempt to repair the unit or take any direct action.

Contact qualified personnel only.

Units shall be repaired exclusively by a servicing centre, duly authorised by the manufacturer, with original spare parts and accessories.

Failure to comply with the above instructions is likely to impair the unit's safety.

To ensure equipment efficiency and proper operation, it is essential that maintenance operations are performed by qualified personnel at regular intervals, following the manufacturer's instructions.

- When a decision is made to discontinue the use of the equipment, those parts likely to constitute sources of danger shall be made harmless.
- In case the equipment is to be sold or transferred to another user, or in case the original user should move and leave the unit behind, make sure that these instructions accompany the equipment at all times so that they can be consulted by the new owner and/or the installer.
- This unit shall be employed exclusively for the use for which it is meant. Any other use shall be considered as improper and, therefore, dangerous.

The manufacturer shall not be held liable, by agreement or otherwise, for damages resulting from improper installation, use and failure to comply with the instructions supplied by the manufacturer. The occurrence of any of the following circumstances may cause explosions, polluting unburnt gases (example: carbon monoxide CO), burns, serious harm to people, animals and things:

- Failure to comply with one of the WARNINGS in this chapter
- Incorrect handling, installation, adjustment or maintenance of the burner
- Incorrect use of the burner or incorrect use of its parts or optional supply

### 2) SPECIAL INSTRUCTIONS FOR BURNERS

- The burner should be installed in a suitable room, with ventilation openings complying with the requirements of the regulations in force, and sufficient for good combustion.
- Only burners designed according to the regulations in force should be used.
- This burner should be employed exclusively for the use for which it was designed.
- Before connecting the burner, make sure that the unit rating is the same as delivery mains (electricity, gas oil, or other fuel).
- Observe caution with hot burner components. These are, usually, near to the flame and the fuel pre-heating system, they become hot during the unit operation and will remain hot for some time after the burner has stopped.

When the decision is made to discontinue the use of the burner, the user shall have qualified personnel carry out the following operations:

- a Remove the power supply by disconnecting the power cord from the mains.
- b Disconnect the fuel supply by means of the hand-operated shut-off valve and remove the control handwheels from their spindles.

#### Special warnings

- Make sure that the burner has, on installation, been firmly secured to the appliance, so that the flame is generated inside the appliance fire-box.
- Before the burner is started and, thereafter, at least once a year, have qualified personnel perform the following operations:
  - a set the burner fuel flow rate depending on the heat input of the appliance;
  - b set the flow rate of the combustion-supporting air to obtain a combustion efficiency level at least equal to the lower level required by the regulations in force;
  - c check the unit operation for proper combustion, to avoid any harmful or polluting unburnt gases in excess of the limits permitted by the regulations in force;
  - d make sure that control and safety devices are operating properly;
  - e make sure that exhaust ducts intended to discharge the products of combustion are operating properly;
  - f on completion of setting and adjustment operations, make sure that all mechanical locking devices of controls have been duly tightened;
  - g make sure that a copy of the burner use and maintenance instructions is available in the boiler room.
- In case of a burner shut-down, reset the control box by means of the RESET pushbutton. If a second shut-down takes place, call the Technical Service, **without trying to RESET further**.
- The unit shall be operated and serviced by qualified personnel only, in compliance with the regulations in force.

### 3) GENERAL INSTRUCTIONS DEPENDING ON FUEL USED

#### 3a) ELECTRICAL CONNECTION

- For safety reasons the unit must be efficiently earthed and installed as required by current safety regulations.
- It is vital that all safety requirements are met. In case of any doubt, ask for an accurate inspection of electrics by qualified personnel, since the manufacturer cannot be held liable for damages that may be caused by failure to correctly earth the equipment.
- Qualified personnel must inspect the system to make sure that it is adequate to take the maximum power used by the equipment shown on the equipment rating plate. In particular, make sure that the system cable cross section is adequate for the power absorbed by the unit.
- No adaptors, multiple outlet sockets and/or extension cables are permitted to connect the unit to the electric mains.
- An omnipolar switch shall be provided for connection to mains, as required by the current safety regulations.
- The use of any power-operated component implies observance of a few basic rules, for example:
  - do not touch the unit with wet or damp parts of the body and/or with bare feet;
  - do not pull electric cables;
  - do not leave the equipment exposed to weather (rain, sun, etc.) unless expressly required to do so;
  - do not allow children or inexperienced persons to use equipment;
- The unit input cable shall not be replaced by the user. In case of damage to the cable, switch off the unit and contact qualified personnel to replace. When the unit is out of use for some time the electric switch supplying all the power-driven components in the system (i.e. pumps, burner, etc.) should be switched off.

### 3b) FIRING WITH GAS, LIGHT OIL OR OTHER FUELS

#### GENERAL

- The burner shall be installed by qualified personnel and in compliance with regulations and provisions in force; wrong installation can cause injuries to people and animals, or damage to property, for which the manufacturer cannot be held liable.
- Before installation, it is recommended that all the fuel supply system pipes be carefully cleaned inside, to remove foreign matter that might impair the burner operation.
- Before the burner is commissioned, qualified personnel should inspect the following:
  - a the fuel supply system, for proper sealing;
  - b the fuel flow rate, to make sure that it has been set based on the firing rate required of the burner;
  - c the burner firing system, to make sure that it is supplied for the designed fuel type;
  - d the fuel supply pressure, to make sure that it is included in the range shown on the rating plate;
  - e the fuel supply system, to make sure that the system dimensions are adequate to the burner firing rate, and that the system is equipped with all the safety and control devices required by the regulations in force.
- When the burner is to remain idle for some time, the fuel supply tap or taps should be closed.

#### SPECIAL INSTRUCTIONS FOR USING GAS

Have qualified personnel inspect the installation to ensure that:

- a the gas delivery line and train are in compliance with the regulations and provisions in force;
  - b all gas connections are tight;
  - c the boiler room ventilation openings are such that they ensure the air supply flow required by the current regulations, and in any case are sufficient for proper combustion.
- Do not use gas pipes to earth electrical equipment.
  - Never leave the burner connected when not in use. Always shut the gas valve off.
  - In case of prolonged absence of the user, the main gas delivery valve to the burner should be shut off.

#### Precautions if you can smell gas

- a do not operate electric switches, the telephone, or any other item likely to generate sparks;
  - b immediately open doors and windows to create an air flow to purge the room;
  - c close the gas valves;
  - d contact qualified personnel.
- Do not obstruct the ventilation openings of the room where gas appliances are installed, to avoid dangerous conditions such as the development of toxic or explosive mixtures.

### DIRECTIVES AND STANDARDS

#### *Gas burners*

##### European directives

- Regulation 2016/426/UE (appliances burning gaseous fuels)
- 2014/35/UE (Low Tension Directive)
- 2014/30/UE (Electromagnetic compatibility Directive)
- 2006/42/EC (Machinery Directive)

##### Harmonized standards

- UNI EN 676 (Automatic forced draught burners for gaseous fuels)
- EN 55014-1 (Electromagnetic compatibility- Requirements for household appliances, electric tools and similar apparatus)
- EN 60204-1:2006 (Safety of machinery – Electrical equipment of machines.)
- CEI EN 60335-1 (Specification for safety of household and similar electrical appliances);
- CEI EN 60335-2-102 (Household and similar electrical appliances. Safety. Particular requirements for gas, oil and solid-fuel burning appliances having electrical connections).
- UNI EN ISO 12100:2010 (Safety of machinery - General principles for design - Risk assessment and risk reduction);

#### *Light oil burners*

##### European directives

- 2014/35/UE (Low Tension Directive)
- 2014/30/UE (Electromagnetic compatibility Directive)
- 2006/42/EC (Machinery Directive)

##### Harmonized standards

- UNI EN 267-2011(Automatic forced draught burners for liquid fuels)
- EN 55014-1 (Electromagnetic compatibility- Requirements for household appliances, electric tools and similar apparatus)
- EN 60204-1:2006 (Safety of machinery – Electrical equipment of machines.)
- CEI EN 60335-1 (Specification for safety of household and similar electrical appliances);
- CEI EN 60335-2-102 (Household and similar electrical appliances. Safety. Particular requirements for gas, oil and solid-fuel burning appliances having electrical connections).
- UNI EN ISO 12100:2010 (Safety of machinery - General principles for design - Risk assessment and risk reduction);

#### *Heavy oil burners*

##### European Directives

- 2014/35/UE (Low Tension Directive)
- 2014/30/UE (Electromagnetic compatibility Directive)
- 2006/42/EC (Machinery Directive)

##### Harmonized standards

- UNI EN 267(Automatic forced draught burners for liquid fuels)
- EN 55014-1 (Electromagnetic compatibility- Requirements for household appliances, electric tools and similar apparatus)
- EN 60204-1:2006 (Safety of machinery – Electrical equipment of machines.)
- CEI EN 60335-1 (Specification for safety of household and similar electrical appliances);
- CEI EN 60335-2-102 (Household and similar electrical appliances. Safety. Particular requirements for gas, oil and solid-fuel burning appliances having electrical connections).
- UNI EN ISO 12100:2010 (Safety of machinery - General principles for design - Risk assessment and risk reduction);

### Gas - Light oil burners

#### European Directives

- Regulation 2016/426/UE (appliances burning gaseous fuels)
- 2014/35/UE (Low Tension Directive)
- 2014/30/UE (Electromagnetic compatibility Directive)
- 2006/42/EC (Machinery Directive)

#### Harmonized standards

- UNI EN 676 (Automatic forced draught burners for gaseous fuels)
- UNI EN 267 (Automatic forced draught burners for liquid fuels)
- EN 55014-1 (Electromagnetic compatibility- Requirements for household appliances, electric tools and similar apparatus)
- EN 60204-1:2006 (Safety of machinery – Electrical equipment of machines.)
- CEI EN 60335-1 (Specification for safety of household and similar electrical appliances);
- CEI EN 60335-2-102 (Household and similar electrical appliances. Safety. Particular requirements for gas, oil and solid-fuel burning appliances having electrical connections).
- UNI EN ISO 12100:2010 (Safety of machinery - General principles for design - Risk assessment and risk reduction);

### Gas - Heavy oil burners

#### European directives:

- Regulation 2016/426/UE (appliances burning gaseous fuels)
- 2014/35/UE (Low Tension Directive)
- 2014/30/UE (Electromagnetic compatibility Directive)
- 2006/42/EC (Machinery Directive)

#### Harmonized standards

- UNI EN 676 (Automatic forced draught burners for gaseous fuels)
- EN 55014-1 (Electromagnetic compatibility- Requirements for household appliances, electric tools and similar apparatus)
- EN 60204-1:2006 (Safety of machinery – Electrical equipment of machines.)
- CEI EN 60335-1 (Specification for safety of household and similar electrical appliances);
- CEI EN 60335-2-102 (Household and similar electrical appliances. Safety. Particular requirements for gas, oil and solid-fuel burning appliances having electrical connections).
- UNI EN ISO 12100:2010 (Safety of machinery - General principles for design - Risk assessment and risk reduction);

### Industrial burners

#### European directives

- Regulation 2016/426/UE (appliances burning gaseous fuels)
- 2014/35/UE (Low Tension Directive)
- 2014/30/UE (Electromagnetic compatibility Directive)
- 2006/42/EC (Machinery Directive)

#### Harmonized standards

- EN 55014-1 (Electromagnetic compatibility- Requirements for household appliances, electric tools and similar apparatus)
- EN 746-2 (Industrial thermoprocessing equipment - Part 2: Safety requirements for combustion and fuel handling systems)
- UNI EN ISO 12100:2010 (Safety of machinery - General principles for design - Risk assessment and risk reduction);
- EN 60204-1:2006 (Safety of machinery – Electrical equipment of machines.)
- EN 60335-2 (Electrical equipment of non-electric appliances for household and similar purposes. Safety requirements)

### Burner data plate

For the following information, please refer to the data plate:

- burner type and burner model: must be reported in any communication with the supplier
- burner ID (serial number): must be reported in any communication with the supplier
- date of production (year and month)
- information about fuel type and network pressure

Type	--
Model	--
Year	--
S.Number	--
Output	--
Oil Flow	--
Fuel	--
Category	--
Gas Pressure	--
Viscosity	--
El.Supply	--
El.Consump.	--
Fan Motor	--
Protection	--
Drwaing n°	--
P.I.N.	--

### SYMBOLS USED



**WARNING!**

Failure to observe the warning may result in irreparable damage to the unit or damage to the environment



**DANGER!**

Failure to observe the warning may result in serious injuries or death.



**WARNING!**

Failure to observe the warning may result in electric shock with lethal consequences

Figures, illustrations and images used in this manual may differ in appearance from the actual product.

### BURNER SAFETY

The burners - and the configurations described below - comply with the regulations in force regarding health, safety and the environment. For more in-depth information, refer to the declarations of conformity that are an integral part of this Manual.



**DANGER! Incorrect motor rotation can seriously damage property and injure people.**

### Residual risks deriving from misuse and prohibitions

The burner has been built in order to make its operation safe; there are, however, residual risks.



Do not touch any mechanical moving parts with your hands or any other part of your body. Injury hazard  
Do not touch any parts containing fuel (i.e. tank and pipes). Scalding hazard  
Do not use the burner in situations other than the ones provided for in the data plate.  
Do not use fuels other than the ones stated.  
Do not use the burner in potentially explosive environments.  
Do not remove or by-pass any machine safety devices.  
Do not remove any protection devices or open the burner or any other component while the burner is running.  
Do not disconnect any part of the burner or its components while the burner is running.  
Untrained staff must not modify any linkages.



After any maintenance, it is important to restore the protection devices before restarting the machine.  
All safety devices must be kept in perfect working order.  
Personnel authorized to maintain the machine must always be provided with suitable protections.



**ATTENTION:** while running, the parts of the burner near the generator (coupling flange) are subject to overheating. Where necessary, avoid any contact risks by wearing suitable PPE.

## PART I: INSTALLATION

## GENERAL FEATURES

Monobloc burners of this series are made in die-cast aluminium housing with relative flange to work on heating generators. The output range is from 150kW to 1900kW (according to the model). They can be provided in progressive or fully-modulating version.

The fuel coming from the supply line, is pushed by the pump to the nozzle and then into the combustion chamber, where the mixture between fuel and air takes place and consequently the flame.

In the burners, the mixture between fuel and air, to perform clean and efficient combustion, is activated by atomisation of oil into very small particles. This process is achieved making pressurised oil pass through the nozzle.

The pump main function is to transfer oil from the tank to the nozzle at required quantity and pressure. To adjust pressure, pumps are provided with a pressure governor (except some models for which a separate adjusting valve is provided). Other pumps are provided with two pressure governors: one for high and one for low pressure (in double-stage systems with one nozzle).

In the double-stage burners, the electric actuator, that moves the air damper, allows the optimisation of the gas flue values, as to get an efficient combustion. The position of the combustion head determines the burner output. The air (comburent) and fuel (light oil) are forced into the combustion chamber, as to let the flame light up.

**How to interpret the burner's "Performance curve"**

To check if the burner is suitable for the boiler to which it must be installed, the following parameters are needed:

- furnace input, in kW or kcal/h ( $\text{kW} = \text{kcal/h} / 860$ );
- backpressure (data are available on the boiler ID plate or in the user's manual).

Example:

Furnace input: 600kW

Backpressure: 4mbar

In the "Performance curve" diagram (Fig. 1), draw a vertical line matching the furnace input value and an horizontal line matching the backpressure value. The burner is suitable if the intersection point A is inside the performance curve.

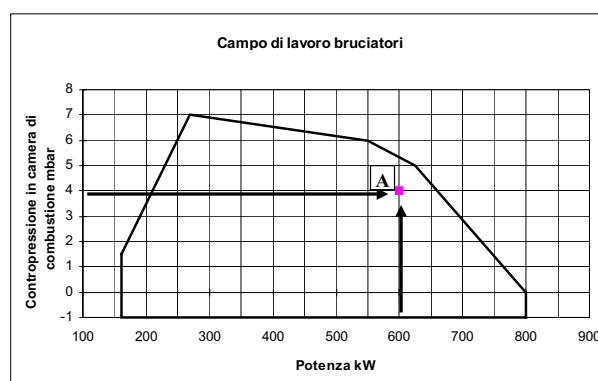

Fig. 1

Data are referred to standard conditions: atmospheric pressure at 1013mbar, ambient temperature at 15°C

## PART I: INSTALLATION

## GENERAL FEATURES

Monobloc burners of this series are made in die-cast aluminium housing with relative flange to work on heating generators. The output range is from 150kW to 1900kW (according to the model). They can be provided in progressive or fully-modulating version.

The fuel coming from the supply line, is pushed by the pump to the nozzle and then into the combustion chamber, where the mixture between fuel and air takes place and consequently the flame.

In the burners, the mixture between fuel and air, to perform clean and efficient combustion, is activated by atomisation of oil into very small particles. This process is achieved making pressurised oil pass through the nozzle.

The pump main function is to transfer oil from the tank to the nozzle at required quantity and pressure. To adjust pressure, pumps are provided with a pressure governor (except some models for which a separate adjusting valve is provided). Other pumps are provided with two pressure governors: one for high and one for low pressure (in double-stage systems with one nozzle).

In the double-stage burners, the electric actuator, that moves the air damper, allows the optimisation of the gas flue values, as to get an efficient combustion. The position of the combustion head determines the burner output. The air (comburent) and fuel (light oil) are forced into the combustion chamber, as to let the flame light up.

**How to interpret the burner's "Performance curve"**

To check if the burner is suitable for the boiler to which it must be installed, the following parameters are needed:

- furnace input, in kW or kcal/h ( $\text{kW} = \text{kcal/h} / 860$ );
- backpressure (data are available on the boiler ID plate or in the user's manual).

Example:

Furnace input: 600kW

Backpressure: 4mbar

In the "Performance curve" diagram (Fig. 1), draw a vertical line matching the furnace input value and an horizontal line matching the backpressure value. The burner is suitable if the intersection point A is inside the performance curve.

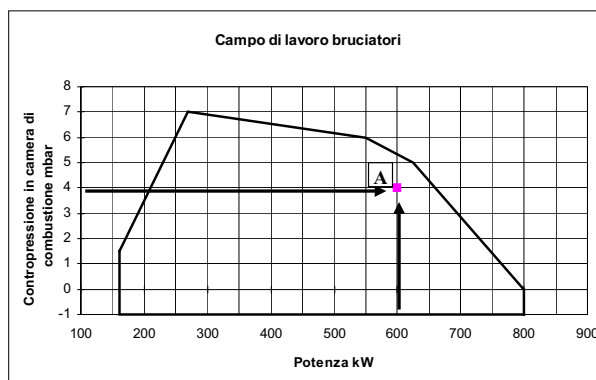

Fig. 1

Data are referred to standard conditions: atmospheric pressure at 1013mbar, ambient temperature at 15°C

**Burner model identification**

Burners are identified by burner type and model. Burner model identification is described as follows.

Type <b>PG60</b> (1)	Model (2)	<b>G-</b> (3)	<b>PR.</b> (4)	<b>S.</b> (5)	<b>*</b> (6)	<b>A.</b> (7)	<b>EA.</b> (8)
(1) BURNER TYPE	<b>PG60-PG70-PG81</b>						
(2) FUEL	<b>G</b> - Light oil		<b>A</b> - Biodiesel				
(3) OPERATION(Available versions)	<b>PR</b> - Progressive			<b>MD</b> - Fully modulating			
(4) BLAST TUBE	<b>S</b> - Standard			<b>L</b> - Extended			
(5) DESTINATION COUNTRY	* - see data plate*						
(6) BURNER VERSION	A - Standard Y - Speciale						
MICRO-PROCESSOR CONTROL	EA = micro-processor control, without inverter EB = micro-processor control, with inverter						

<b>BURNERS</b>		<b>PG60</b>	<b>PG70</b>	<b>PG81</b>
Output	min. -max. kW	151 - 791	291 - 1047	264 - 1900
Fuel		Light oil		
Light oil rate	min. -max. kg/h	13 - 67	25 - 88	22 - 160
Viscosity		1.3 °E @20°C		
Power supply		400V 3N ~ 50Hz		
Motor	kW	1,1	2,2	3
Total power consumption	kW	1,6	2,7	3,5
Separate pump motor (if supplied)	kW	-	-	0,55
Total power consumption (pump motor + fan motor)	kW	-	-	4,05
Approx. weight	kg	55	85	85
Operation		Progressive - Fully modulating		
Operating temperature	°C	-10 ÷ +50		
Storage Temperature	°C	-20 ÷ +60		
Working service*		Intermittent		

(\* ) **NOTE ON THE WORKING SERVICE:** the control box automatically stops after 24h of continuous working. The control box immediately starts up, automatically.

**Technical specifications Performance curves**

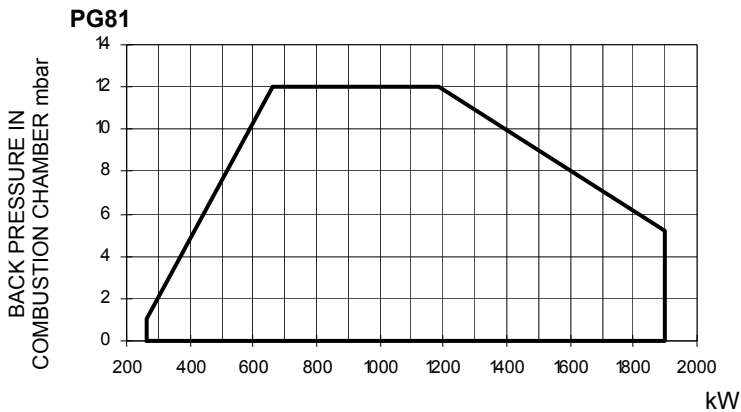
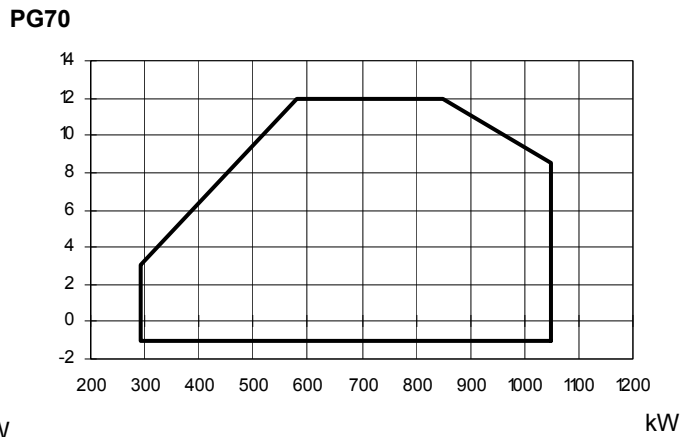
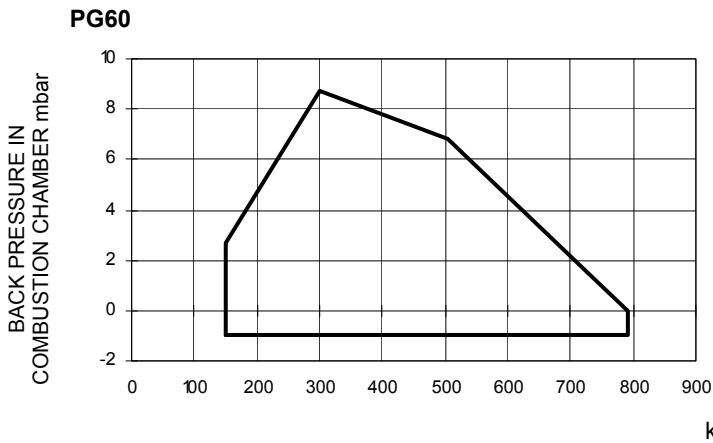

To get the input in kcal/h, multiply value in kW by 860.

Data are referred to standard conditions: atmospheric pressure at 1013mbar, ambient temperature at 15°C.

Overall dimensions (mm) - PG60

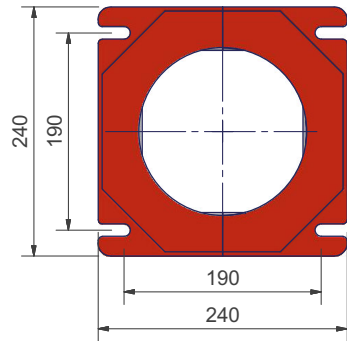
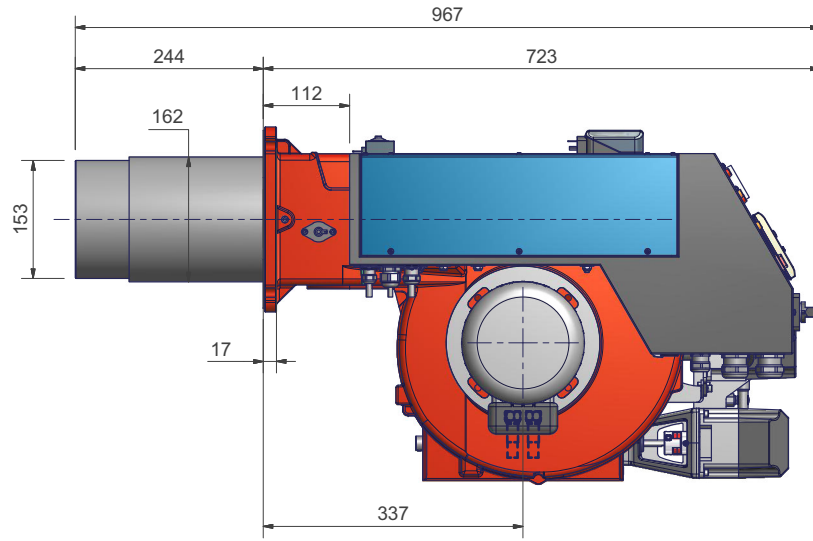
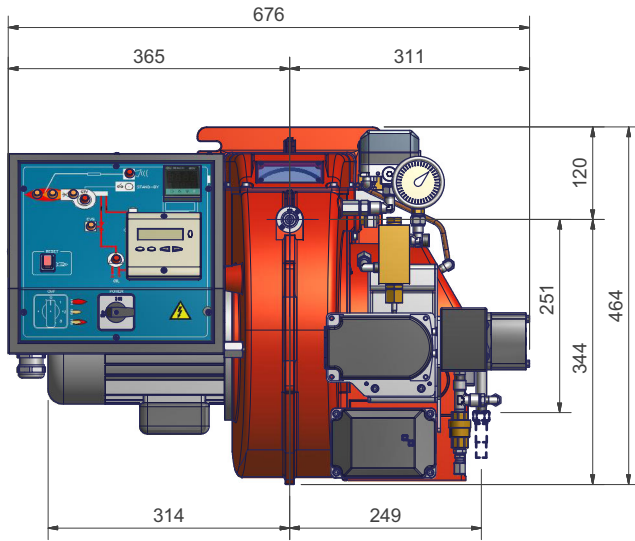

Burner flange

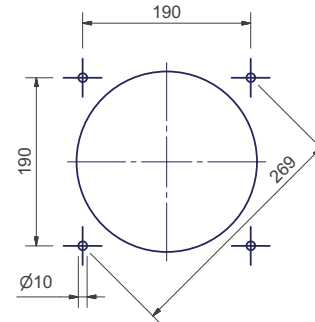

Suggested boiler drilling template

**Overall dimensions (mm) - PG70, PG81**

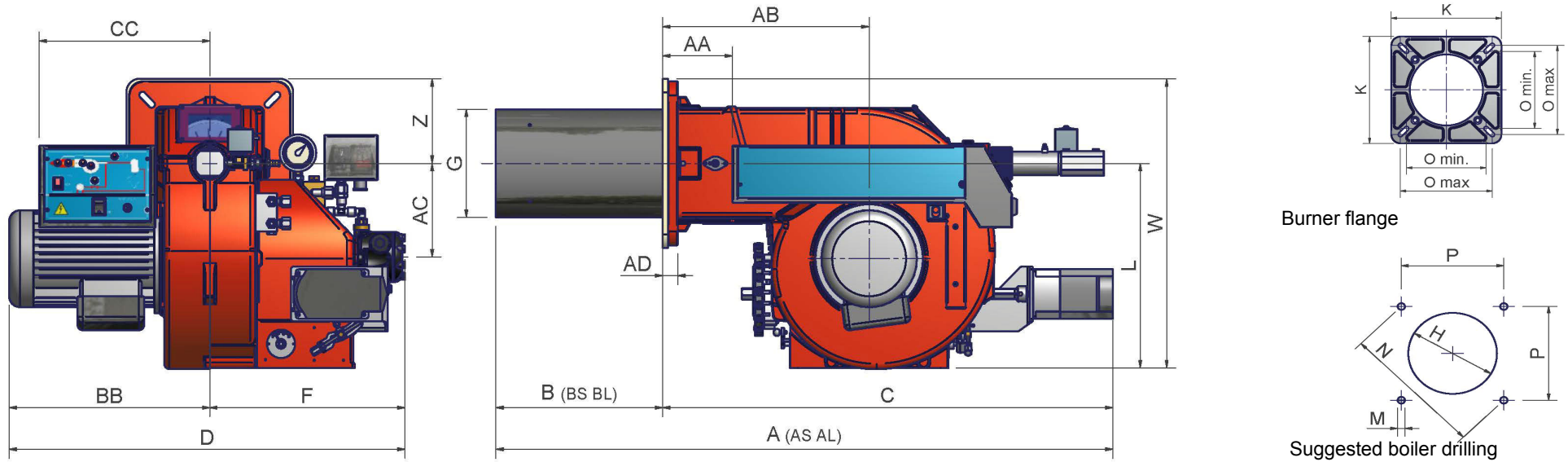

6

	AS	AL	AA	BS	BL	BB	C	CC	D	F	G	K	H	L	Omin	Omax	P	M	N	P	W	Z
<b>PG70</b>	1147	1297	130	310	460	373	837	317	736	363	198	300	228	374	216	250	233	M10	330	233	529	155
<b>PG81</b>	1177	1327	139	340	490	373	837	382	736	363	234	300	264	376	216	250	233	M10	330	233	531	155

\*B, C = measure referred to burner fitted with standard blast tube

\*BL, CL = measure referred to burner fitted with extended blast tube

(PG60, PG70, PG81) HYDRAULIC DIAGRAMS

Fig. 3 - 3I2G-24 v0 Hydraulic diagram

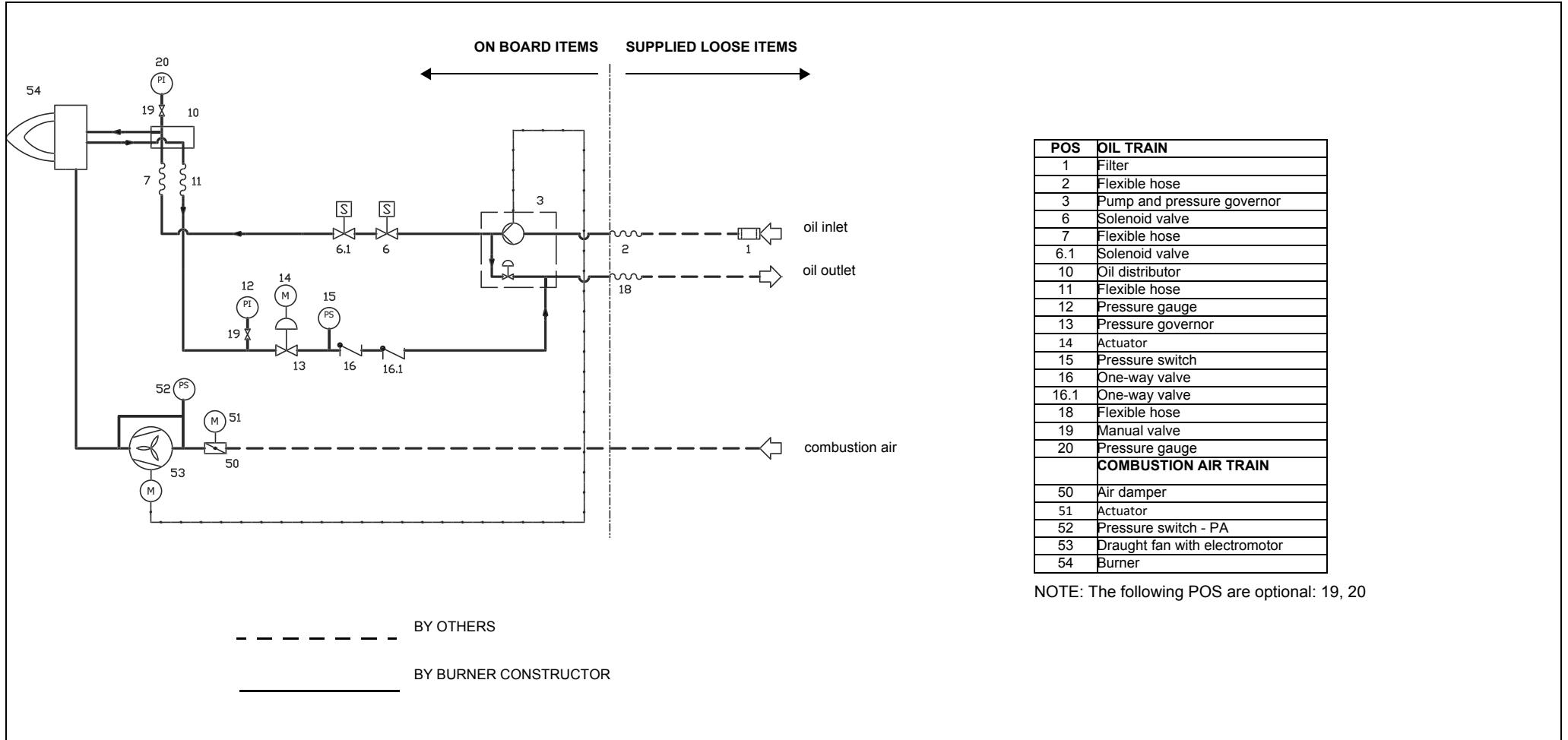

10

PART I: INSTALLATION

(PG81) HYDRAULIC DIAGRAMS - (version with a separate pump motor)

Fig. 4 - 3I2G-23 v0 Hydraulic diagram

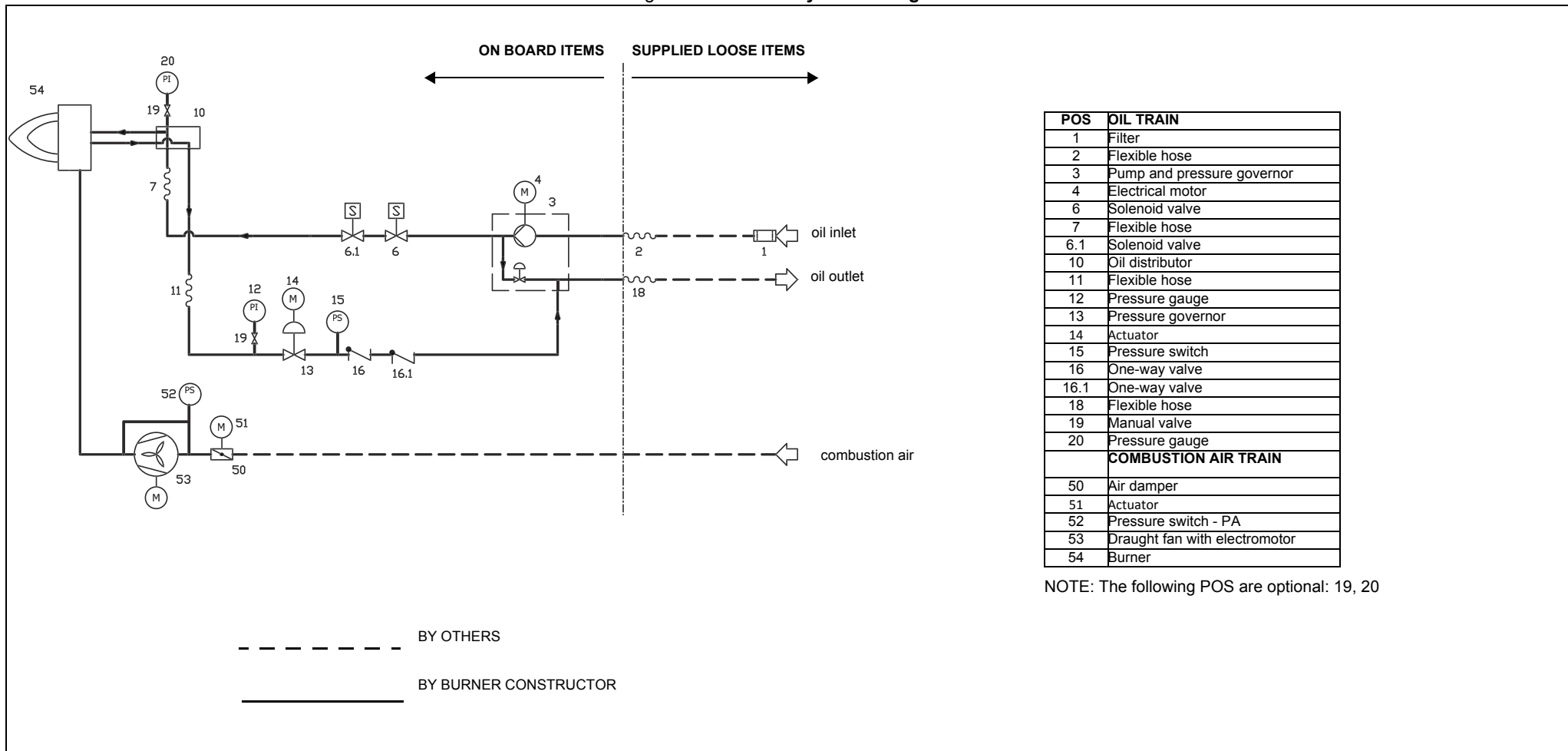

NOTE: The following POS are optional: 19, 20

Fig. 5

## MOUNTINGS AND CONNECTIONS

### Packing

The burners are dispatched in wooden packages whose dimensions are:

PG60: 1200 x 670 x 540 mm (L x P x H)

PG70-PG81: 1400 x 1000 x 220 mm (L x P x H)

Packing cases of this kind are affected by humidity and are not suitable for stacking. The following are placed in each packing case.

- 1 burner;
- 2 light oil flexible hoses;
- 1 light oil filter;
- 1 gasket to be inserted between the burner and the boiler;
- 1 envelope containing this manual.

To get rid of the burner's packing, follow the procedures laid down by current laws on disposal of materials.

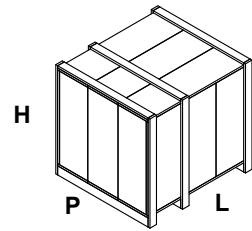

### Fitting the burner to the boiler

To install the burner into the boiler, proceed as follows:

- 1 make a hole on the closing door of the combustion chamber as described on paragraph "Overall dimensions")
- 2 place the burner to the boiler: lift it up and handle it according to the procedure described on paragraph "Handling the burner";
- 3 place the stud bolts (5) on boiler's door, according to the burner drilling template described on paragraph "Overall dimensions";
- 4 fasten the stud bolts;
- 5 place the gasket on the burner flange;
- 6 install the burner into the boiler;
- 7 fix the burner to the stud bolts, by means of the fixing nuts, according to the next picture.
- 8 After fitting the burner to the boiler, ensure that the gap between the blast tube and the refractory lining is sealed with appropriate insulating material (ceramic fibre cord or refractory cement).

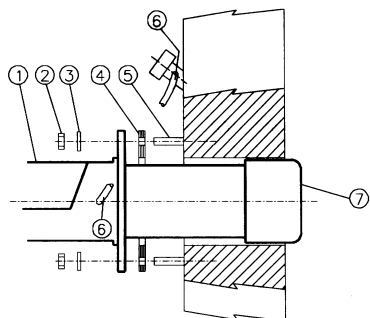

#### Keys

- 1 Burner
- 2 Fixing nut
- 3 Washer
- 4 Sealing gasket
- 5 Stud bolt
- 7 Blast tube

### Handling the burner



**ATTENTION!** The handling operations must be carried out by specialised and trained personnel. If these operations are not carried out correctly, the residual risk for the burner to overturn and fall down still persists.

To move the burner, use means suitable to support its weight (see paragraph "Technical specifications").

**Hydraulic diagrams for light oil supplying circuits**

Fig. 6 - Gravity circuit

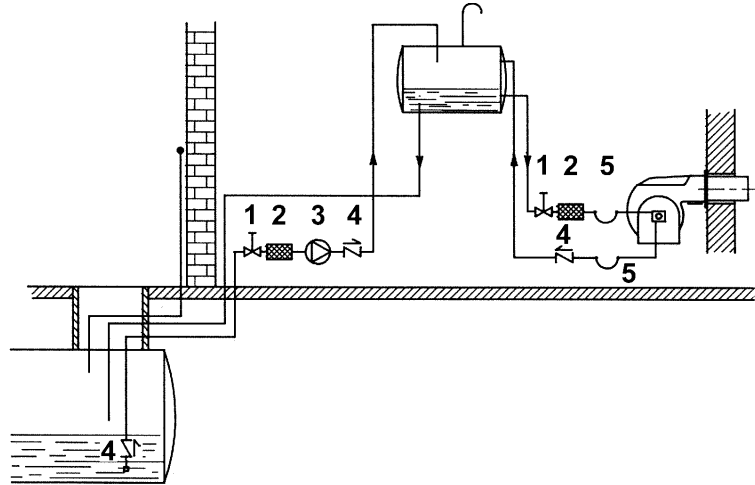

Fig. 7 - Ring circuit

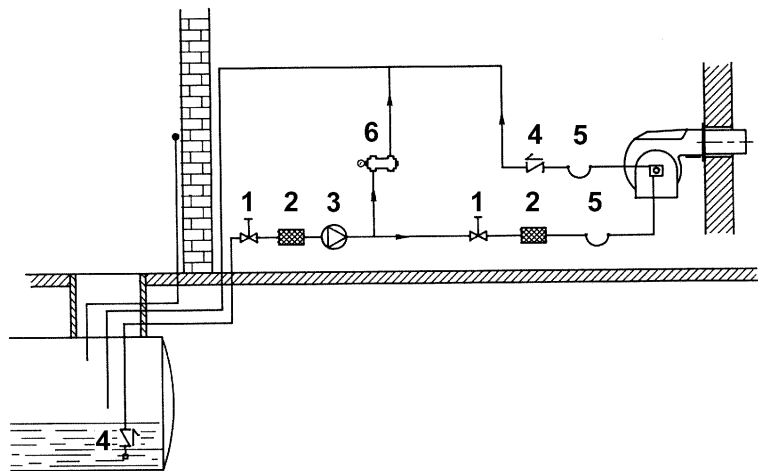
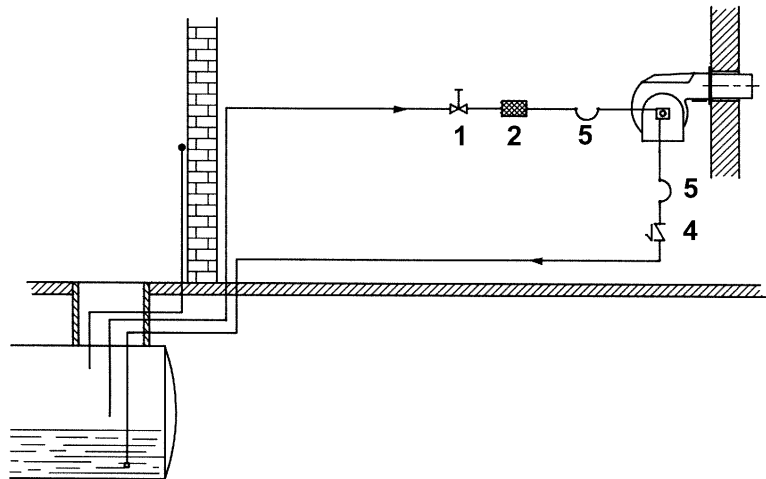

Fig. 8 - Suction circuit



**Key**

- 1 Manual valve
- 2 Light oil filter
- 3 Light oil feeding pump
- 4 One way valve
- 5 Flexible hoses
- 6 Relief valve

**NOTE:** in plants where gravity or ring feed systems are provided, install an automatic interception device (see n. 4 - Fig. 9).

## Installation diagram of light oil pipes

**!** PLEASE READ CAREFULLY THE “WARNINGS” CHAPTER AT THE BEGINNING OF THIS MANUAL.

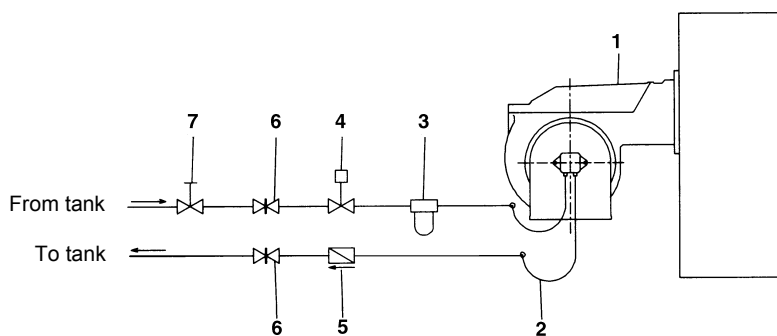

Fig. 9 - Double-pipe system

The burner is supplied with filter and flexible hoses, all the parts upstream the filter and downstream the return flexible hose, must be installed by the customer. As far as the hoses connection, see the related paragraph.

### Key

- 1 Burner
- 2 Flexible hoses (fitted)
- 3 Light oil filter (fitted)
- 4 Automatic interceptor (\*)
- 5 One-way valve (\*)
- 6 Gate valve
- 7 Quick-closing gate-valve (outside the tank or boiler rooms)

(\*) Only for installations with gravity, siphon or forced circulation feed systems. If the device installed is a solenoid valve, a timer must be installed to delay the valve closing.

The direct connection of the device without a timer may cause pump breaks.

The provided pumps can be installed both into single-pipe and double-pipe systems.

**Single-pipe system:** a single pipe drives the oil from the tank to the pump's inlet. Then, from the pump, the pressurised oil is driven to the nozzle: a part comes out from the nozzle while the other part goes back to the pump. In this system, the by-pass plug, if provided, must be removed and the optional return port, on the pump's body, must be sealed by steel plug and washer.

**Double-pipe system:** as for the single pipe system, a pipe that connects the tank to the pump's inlet is used besides another pipe that connects the pump's return port to the tank, as well. The excess of oil goes back to the tank: this installation can be considered self-bleeding. If provided, the inside by-pass plug must be installed to avoid air and fuel passing through the pump.

Burners are factory-set for double-stage systems. They can be suited for single-pipe system (recommended in the case of gravity feed) as described before. To change from a 1-pipe system to a 2-pipe-system, insert the by-pass plug **G** (as for ccw-rotation- referring to the pump shaft).

**Caution:** Changing the direction of rotation, all connections on top and side are reversed.

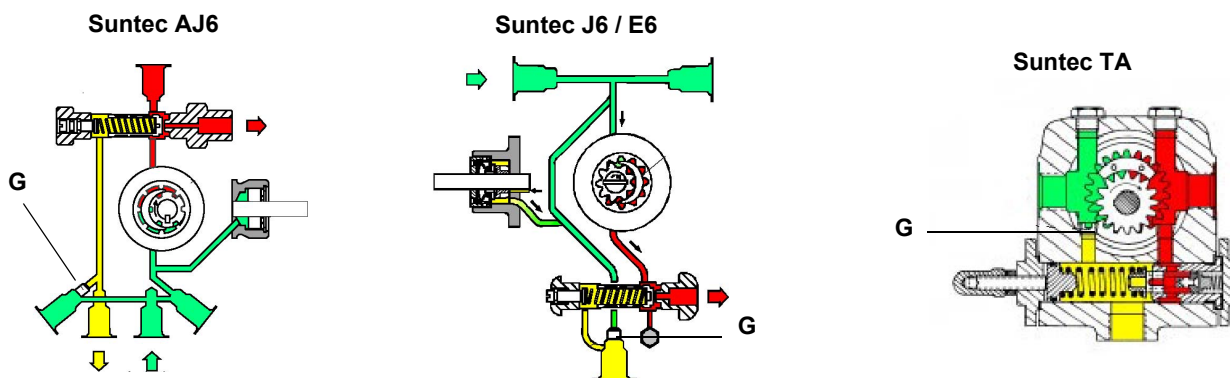

### Bleed

Bleeding in two-pipe operation is automatic: it is assured by a bleed flat on the piston. In one-pipe operation, the plug of a pressure gauge port must be loosened until the air is evacuated from the system.

The pumps provided with these burners can be:

- PG60: Suntec AJ6 / E6
- PG70: Suntec J6

- PG81: Suntec TA2 / HP- UHE-A

<b>Pump Suntec AJ6</b>	
Viscosity	2.8 - 75 cSt
Oil temperature	60°C max
Inlet maximum pressure	2 bar
Inlet minimum pressure	- 0.45 bar to avoid gasing
Rated speed	3600 rpm max.

<b>Suntec J6 - J7</b>	
Oil viscosity	2.8 - 200 cSt
Oil temperature	0 - 90°C
Min. suction pressure	- 0,45 bar to avoid gasing
Max. suction pressure	1.5 bar
Max. return pressure	1.5 bar
Rotation speed	3600 rpm max.

**Key**

- 1 Pressure governor
- 2 Pressure gauge
- 3 Vacuum gauge
- 5 Nozzle
- 7 Suction
- 8 Return

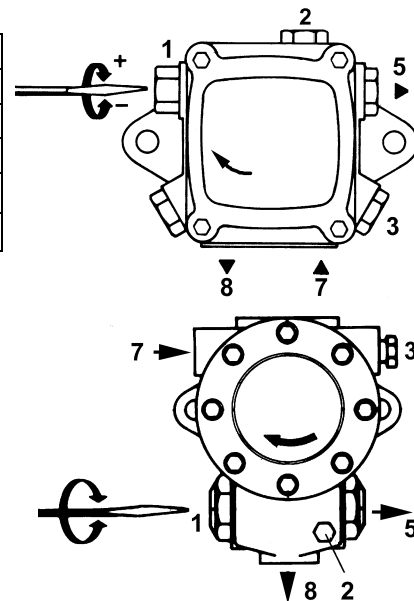

**About the use of fuel pumps**

- Make sure that the by-pass plug is not used in a single pipe installation, because the fuel unit will not function properly and damage to the pump and burner motor could result.
- Do not use fuel with additives to avoid the possible formation over time of compounds which may deposit between the gear teeth, thus obstructing them.
- After filling the tank, wait before starting the burner. This will give any suspended impurities time to deposit on the bottom of the tank, thus avoiding the possibility that they might be sucked into the pump.
- On initial commissioning a "dry" operation is foreseen for a considerable length of time (for example, when there is a long suction line to bleed). To avoid damages inject some lubrication oil into the vacuum inlet.
- Care must be taken when installing the pump not to force the pump shaft along its axis or laterally to avoid excessive wear on the joint, noise and overloading the gears.
- Pipes should not contain air pockets. Rapid attachment joint should therefore be avoided and threaded or mechanical seal junctions preferred. Junction threads, elbow joints and couplings should be sealed with removable component. The number of junctions should be kept to a minimum as they are a possible source of leakage.
- Do not use PTFE tape on the suction and return line pipes to avoid the possibility that particles enter circulation. These could deposit on the pump filter or the nozzle, reducing efficiency. Always use O-Rings or mechanical seal (copper or aluminium gaskets) junctions if possible.
- An external filter should always be installed in the suction line upstream of the fuel unit.

**Light oil pumps**

<b>Suntec E6 - E7 1001</b>	
Oil viscosity	3 - 75 cSt
Oil temperature	0 - 90°C
Inlet maximum pressure	1,5 bar
Maximum return pressure	1,5 bar
Minimum inlet pressure	- 0,45 to avoid gasing
Rotation speed	3600 rpm max.

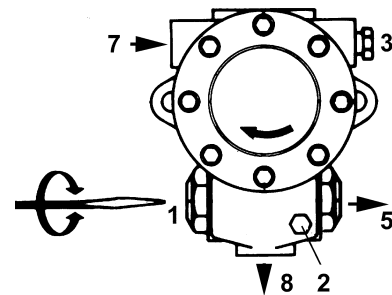

**Key**

- 1. Pressure governor
- 2. Pump pressure gauge
- 3. Vacuum gauge
- 5. To the nozzle
- 7. Inlet
- 8. Return

<b>Suntec TA..</b>	
Oil viscosity	3 ÷ 75 cSt
Oil temperature	0 ÷ 150°C
Min. suction pressure	- 0.45 bar to avoid gasing
Max. suction pressure	5 bar
Max. return pressure	5 bar
Rotation speed	3600 rpm max.

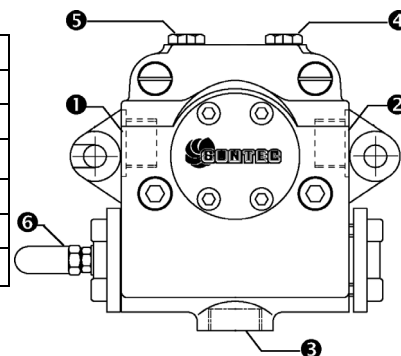

- 1 Inlet G1/2
- 2 To the nozzle G1/2
- 3 Return G1/2
- 4 Pressure gauge port G1/4
- 5 Vacuum gauge port G1/4
- 6 Pressure governor

<b>HP-Technick UHE-A..</b>	
Oil viscosity	3 ÷ 75 cSt
Oil temperature	0 ÷ 150°C
Min. suction pressure	- 0.45 bar to avoid gasing
Max. suction pressure	5 bar
Max. return pressure	5 bar
Rotation speed	3600 rpm max.

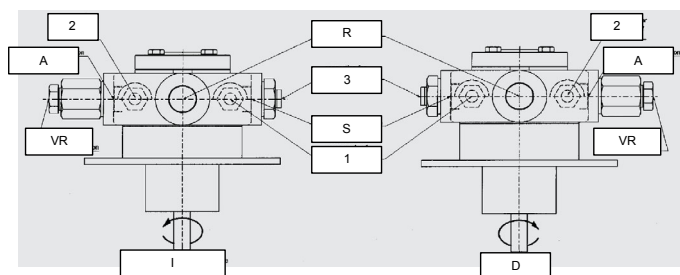

- 1. Connection for manometer 1 – delivery (M1) – G1/4
- 2. Connection for manometer 2 – suction (M2) – G1/4
- 3. Connection for manometer 3 (M3)
- A. Suction connection– G1/2
- D. Direct - clockwise
- I. Indirect – counter clockwise
- R. By-pass connection– G1/2
- S. Delivery connection – G1/2
- VR. After removal of cover screw: pressure regulation



**Connecting the light oil flexible hoses**

To connect the flexible light oil hoses to the pump, proceed as follows, according to the pump provided:

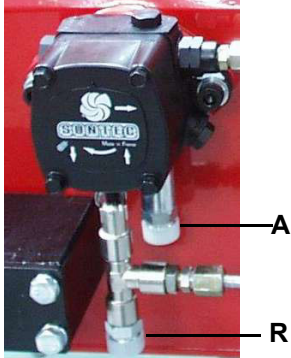
- 1 remove the closing nuts **A** and **R** on the inlet and return connections of the pump;
- 2 screw the rotating nut of the two flexible hoses on the pump **being careful to avoid exchanging the inlet and return lines**: see the arrows marked on the pump that show the inlet and the return (see previous paragraph).

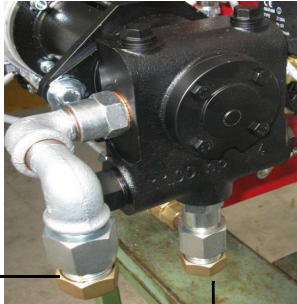
Suntec AJ6	Suntec J6 / E6
 <p data-bbox="730 568 762 591">A</p> <p data-bbox="730 674 762 696">R</p>	 <p data-bbox="831 477 863 499">A</p> <p data-bbox="831 645 863 667">R</p>
Suntec TA	HP Technik UHE-A
 <p data-bbox="512 1111 536 1133">A</p> <p data-bbox="624 1111 647 1133">R</p>	 <p data-bbox="1054 1111 1078 1133">R</p>

### Light oil nozzles

The light oil flow rate can be adjusted choosing a by-pass nozzle that suits the boiler/utilisation's output and setting the delivery and return pressure values according to the values quoted on diagram on Fig. 10.

NOZZLE	NOZZLE SUPPLY PRESSURE bar	HIGH FLAME RETURN PRESSURE bar	LOW FLAME RETURN PRESSURE bar (recommended)
BERGONZO A3	20	11 ÷ 13	5 (recommended)

**Example:** if a 220kg/h flow rate BERGONZO nozzle is provided, set the return pressure at 11bar, supply at 20bar on the delivery to get a 220kg/h flow rate. If the return pressure needed is 5bar, instead, act on the V adjusting screw on the pressure governor. The flow rate will then be about 95kg/h (see the example showed on the Bergonzo diagram).

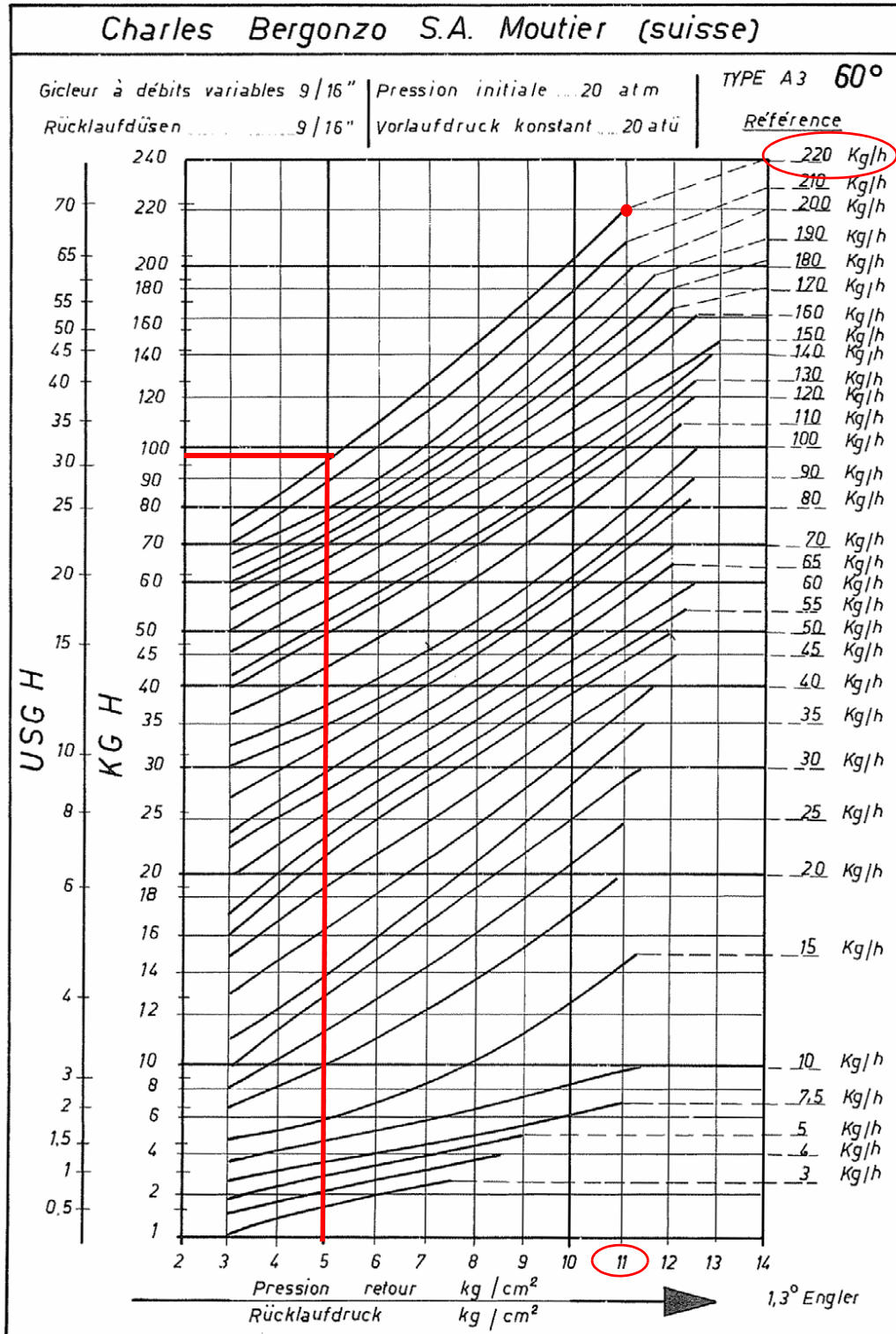
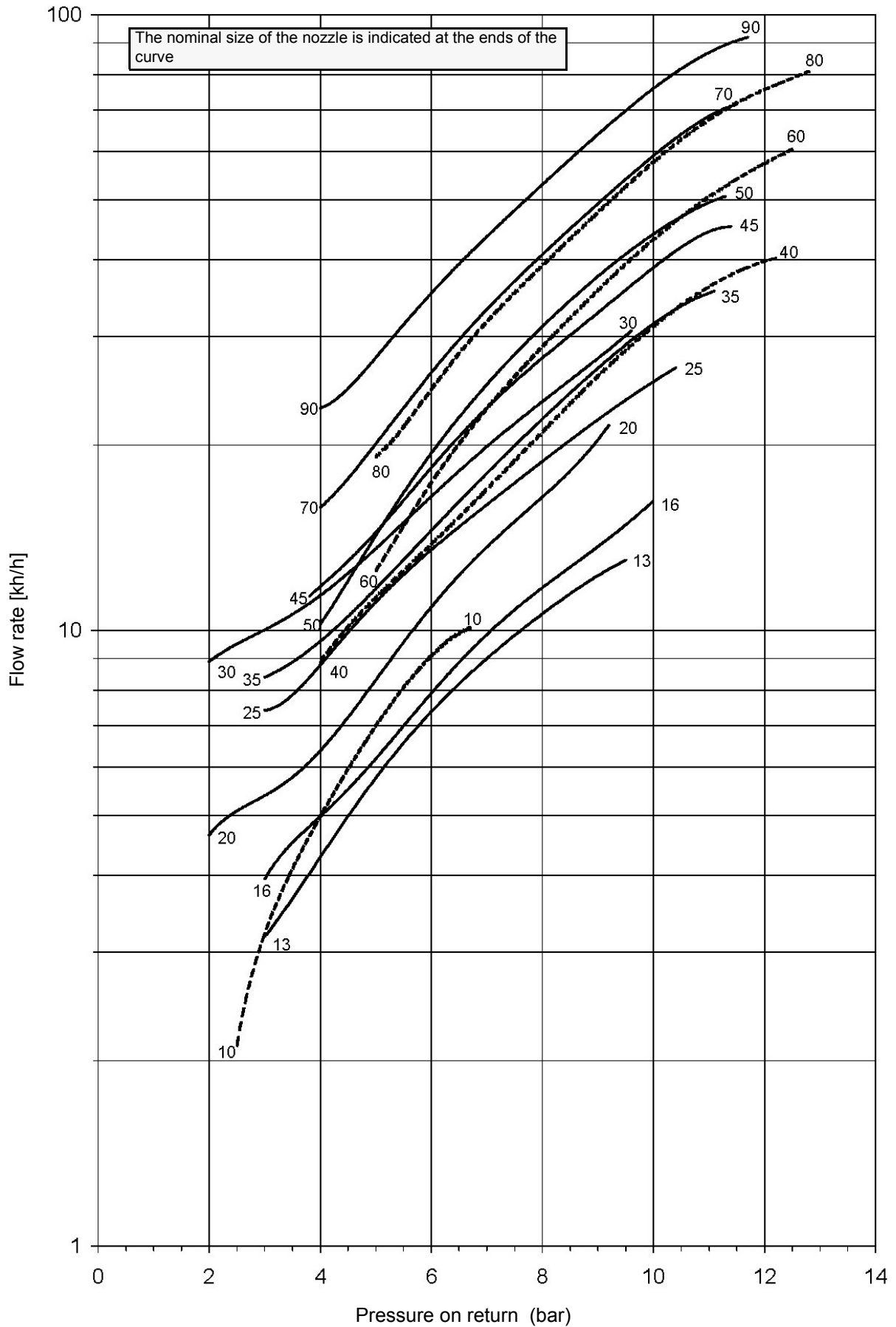

Fig. 10

FLUIDICS KW3...60°

NOZZLE SUPPLY PRESSURE = 20 bar. VISCOSITY AT NOZZLE = 5 cSt



FLUIDICS KW3...60°

NOZZLE SUPPLY PRESSURE = 20 bar. VISCOSITY AT NOZZLE = 5 cSt

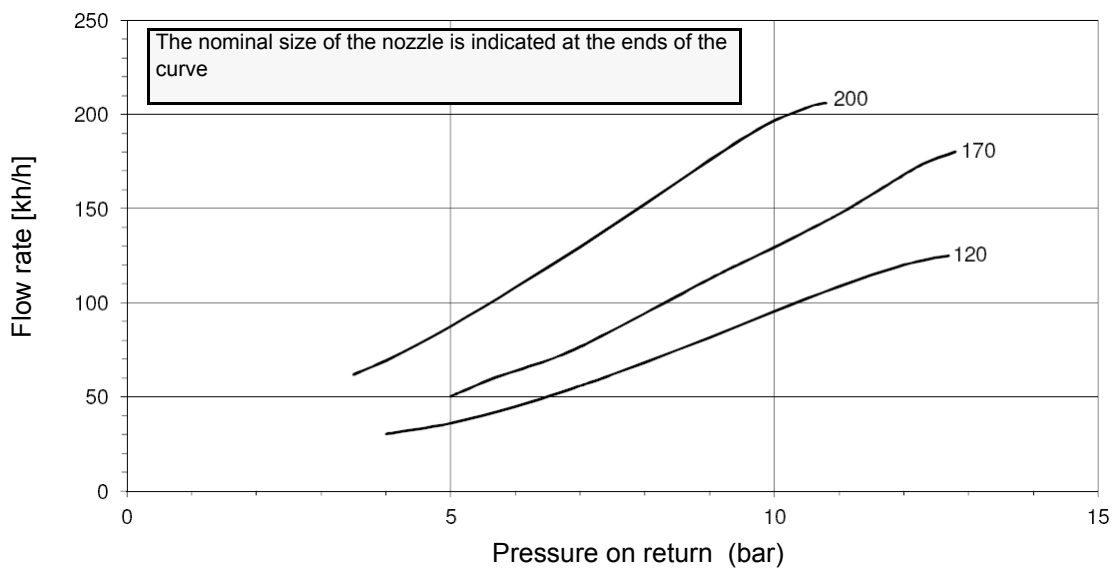
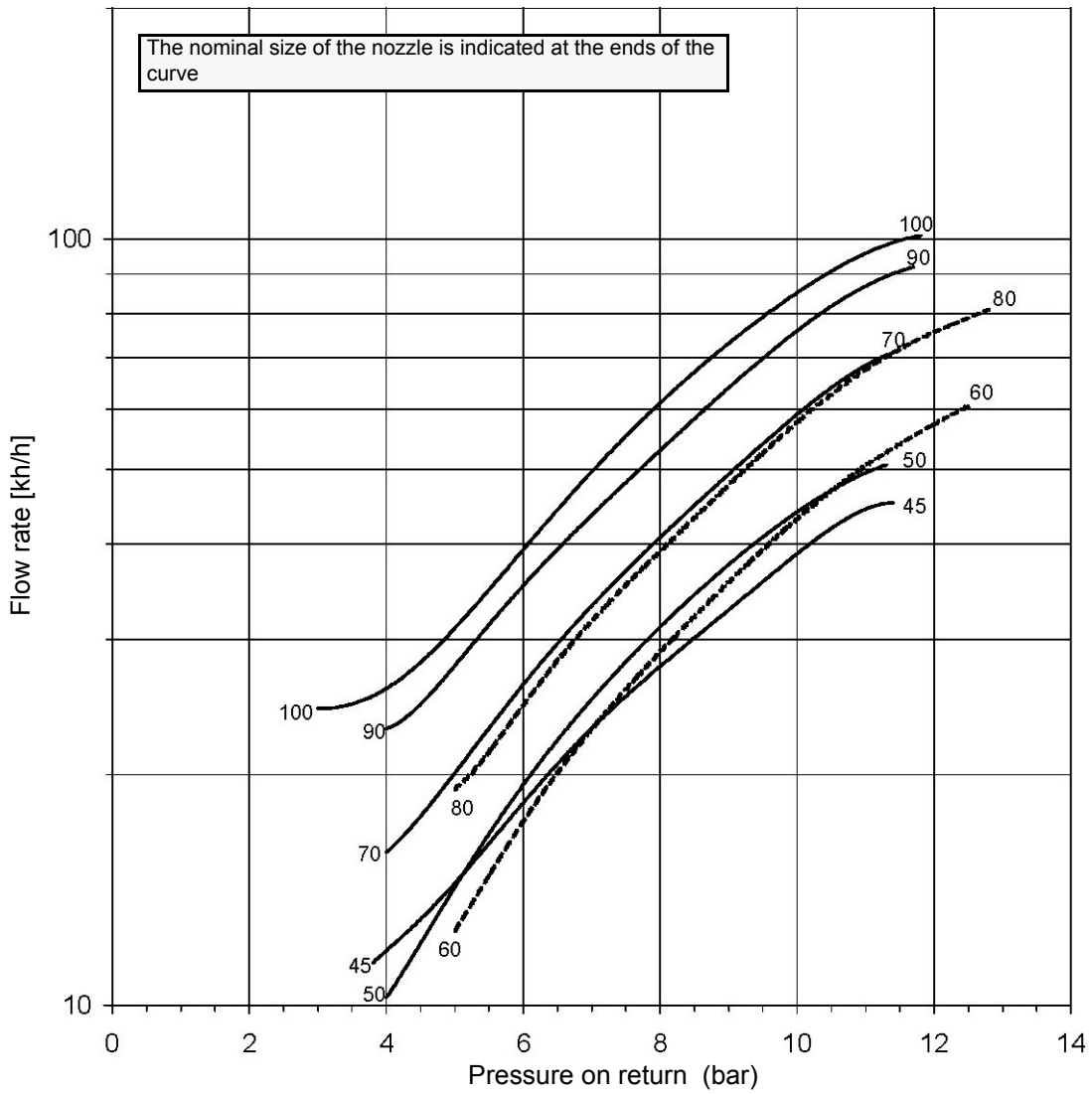

**FLUIDICS KW3...60°**

**NOZZLE SUPPLY PRESSURE = 20 bar. VISCOSITY AT NOZZLE = 5 cSt**

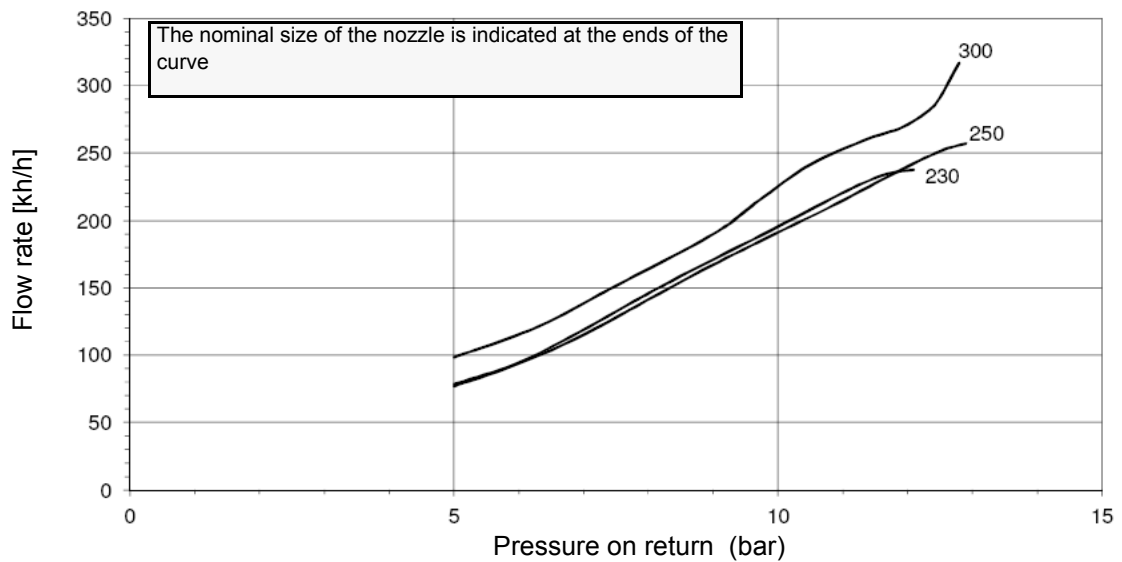
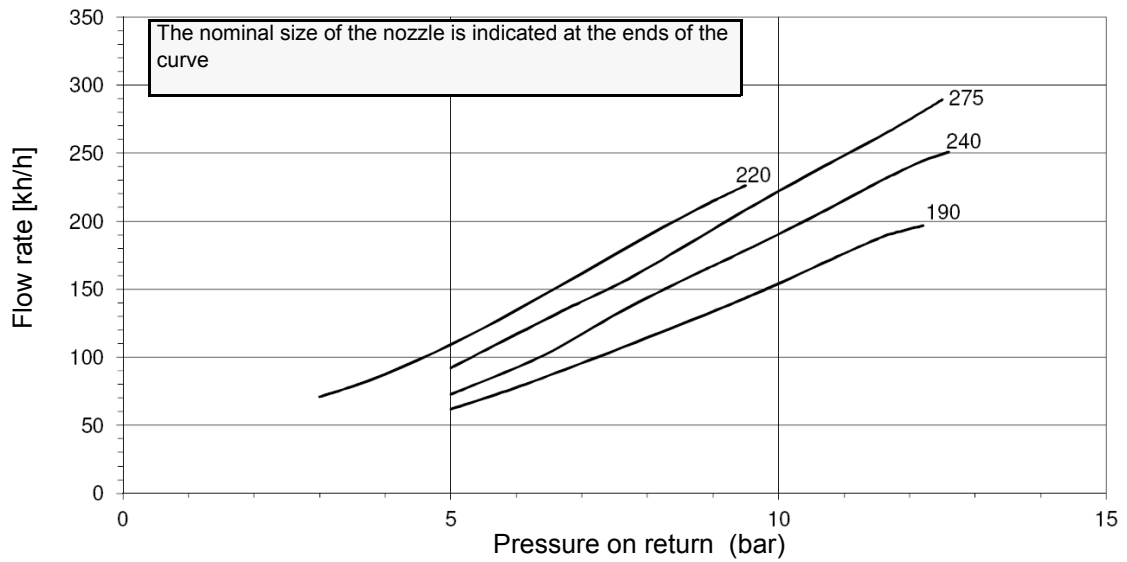
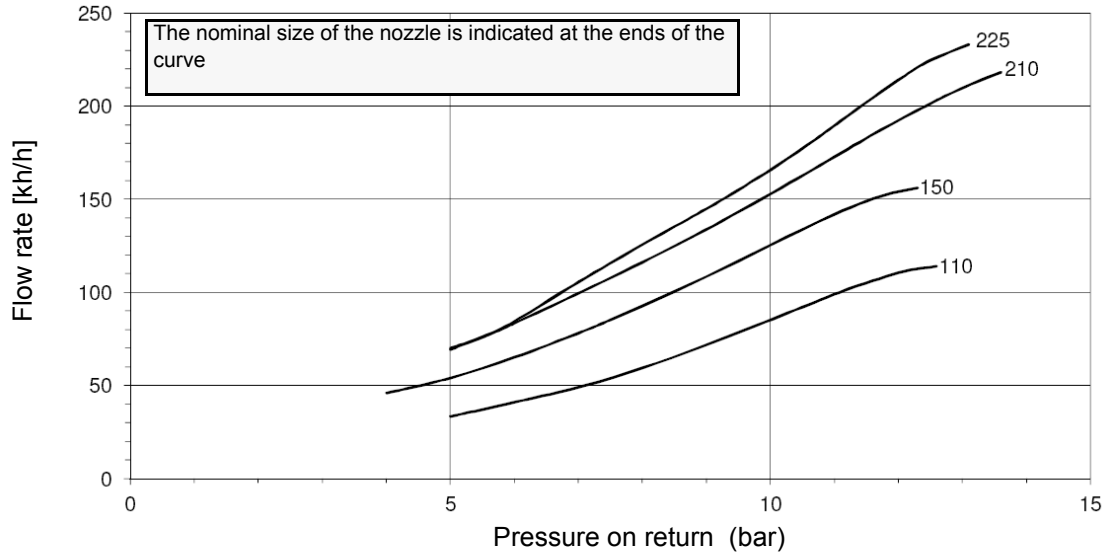

## ELECTRICAL CONNECTIONS



**WARNING!** Respect the basic safety rules. make sure of the connection to the earthing system. do not reverse the phase and neutral connections. fit a differential thermal magnet switch adequate for connection to the mains. **WARNING!** before executing the electrical connections, pay attention to turn the plant's switch to OFF and be sure that the burner's main switch is in 0 position (OFF) too. Read carefully the chapter "WARNINGS", and the "Electrical connections" section.

**ATTENTION:** Connecting electrical supply wires to the burner terminal block MA, be sure that the ground wire is longer than phase and neutral ones.

To execute the electrical connections, proceed as follows:

- 1 remove the cover from the electrical board, unscrewing the fixing screws;
- 2 execute the electrical connections to the supply terminal board as shown in the attached wiring diagrams;
- 3 check the direction of the fan motor (see next paragraph);
- 4 refit the panel cover.



**WARNING:** (only for double stage and progressive burners) The burner is provided with an electrical bridge between terminals 6 and 7; when connecting the high/low flame thermostat, remove this bridge before connecting the thermostat.

### Rotation of electric motor

Once the electrical connection of the burner is executed, remember to check the rotation of the electric motor. The motor should rotate according to the "arrow" symbol on the body. In the event of wrong rotation, reverse the three-phase supply and check again the rotation of the motor.



**CAUTION:** check the motor thermal cut-out adjustment

**NOTE:** the burners are supplied for three-phase 380 V or 400 V supply, and in the case of three-phase 220 V or 230 V supply it is necessary to modify the electrical connections into the terminal box of the electric motor and replace the overload tripped relay.

### Note on electrical supply

In the case where the power supply of the AUXILIARIES of the phase-phase burner (without a neutral), for the flame detection it is necessary to connect the RC circuit Siemens between the terminal 2 (terminal X3-04-4 in case of LMV2x, LMV3x, LMV5x, LME7x) of the base and the earth terminal, RC466890660. For LMV5 control box, please refer to the labeling recommendations available on the Siemens CD attached to the burner

#### Key

C - Capacitor (22 nF , 250 V)

LME / LMV - Siemens control box

R - Resistor (1MΩ)

M:

- Terminal 2 (LGB, LME),

- Terminal X3-04-4 ( LMV2x, LMV3x, LMV5, LME7x)

RC466890660 - RC Siemens filter

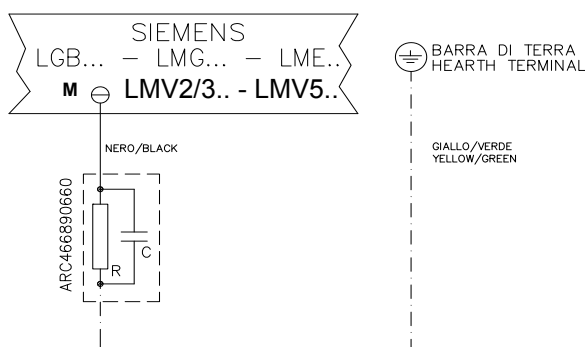

## ADJUSTMENTS

### Adjustments - brief description



**ATTENTION:** before starting the burner up, be sure that the manual cutoff valves are open. Be sure that the mains switch is closed.

Before starting up the burner, make sure that the return pipe to the tank is not obstructed. Any obstruction would cause the pump seal to break.

**ATTENTION:** During commissioning operations, do not let the burner operate with insufficient air flow (danger of formation of carbon monoxide); if this should happen, make the gas decrease slowly until the normal combustion values are achieved.



**IMPORTANT!** the combustion air excess must be adjusted according to the in the following chart:

Recommended combustion parameters		
Fuel	Recommended (%) CO <sub>2</sub>	Recommended (%) O <sub>2</sub>
Light oil	11.5 ÷ 13	2.9 ÷ 4.9

### Adjustments - brief description

The air and fuel rates adjustments must be performed at the maximum output first ("high flame"): see the LMV2.. related manual..

- Check that the combustion parameters are in the suggested limits.
- Then, adjust the combustion values by setting the "fuel/air" ratio" curvepoints (see the LMV2.. related manual).
- Set, now, the low flame output, in order to avoid the low flame output increasing too much or that the flues temperature gets too low to cause condensation in the chimney.

### User interface

The AZL2x.. display is shown below:

The keys functions are the following:



#### Key F

Used to adjust the "fuel" actuator position (**Fuel**): :

While pressing the **F** key, the "fuel" actuator position can be changed by means of the **+** and **-** keys.



#### Key A

Used to adjust the "air" actuator position (**Air**):

While pressing the **A** key, the "air" actuator position can be changed by means of the **+** and **-** keys.

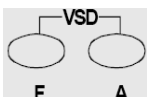

#### Key F + A

While pressing the two keys contemporarily, the **code** message will appear: by entering the proper password it is possible to access the **Service** mode.



#### Info and Enter keys

Used for **Info** and **Service** menus

Used as **Enter** key in the setting modes

Used as **Reset** key in the burner operation mode

Used to enter a lower level menu

#### -Key -

Used to decrease a value

Used to enter Info and Service during the curve adjustments



**+Key +**

Used to increase a a value  
Used to enter Info and Service during the curve adjustments

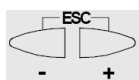

**Keys (+ & -) = ESC**

By pressing + and - at the same time, the ESCAPE function is performed:

to enter a lower level menu

The display will show these data:

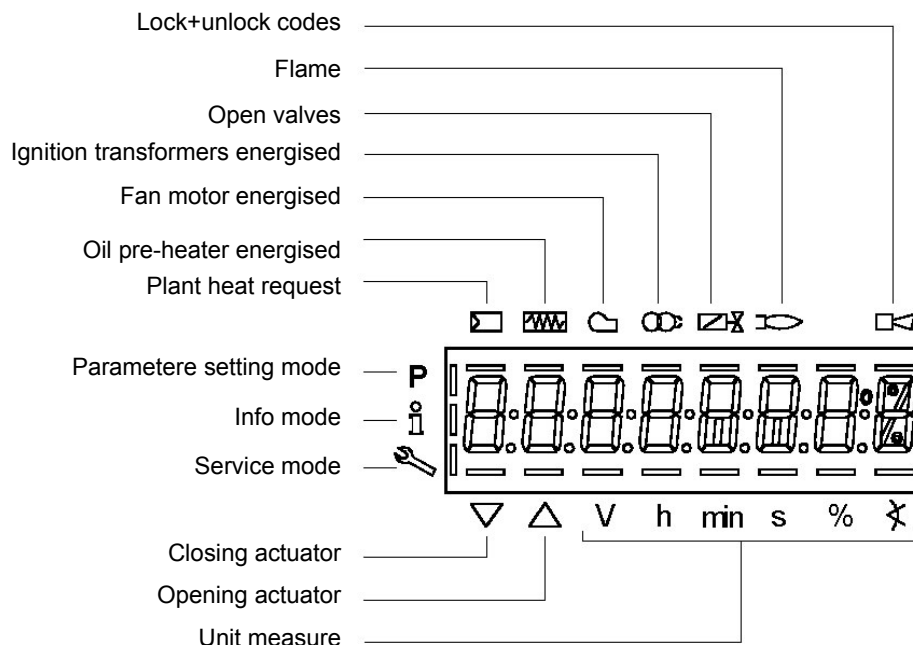

The display will show these data:

**Setting menu**

The setting menu is divided into different blocks:

Bloc.	Descrizione	Description	Password
100	Informazioni generali	General	OEM / Service / Info
200	Controllo bruciatore	Burner control	OEM / Service
400	Curve rapporto	Ratio curves	OEM / Service
500	Controllo rapporto	Ratio control	OEM / Service
600	Servocomandi	Actuators	OEM / Service
700	Storico errori	Error history	OEM / Service / Info
900	Dati di processo	Process data	OEM / Service / Info

The accesses to the various blocks are allowed by passwords. Passwords are divided into three levels:

- User level (info): no password needed
- Service level (Service)
- Manufacturer level (OEM)

**PHASES LIST**

During operation, the following program phases are shown. The meaning for each phase is quoted in the table below

Fase / Phase	Funzione	Function
Ph00	Fase blocco	Lockout phase
Ph01	Fase di sicurezza	Safety phase
Ph10	t10 = tempo raggiungimento posizione riposo	t10 = home run
Ph12	Pausa	Standby (stationary)

Ph22	t22 = tempo di salita ventilatore (motore ventilatore = ON, valvola intercettazione di sicurezza = ON)	t22 = fan ramp up time (fan motor = ON, safety shutoff valve = ON)
Ph24	Verso posizione preventilazione	Traveling to the prepurge position
Ph30	t1 = tempo preventilazione	t1 = prepurge time
Ph36	Verso posizione accensione	Traveling to the ignition position
Ph38	t3 = tempo preaccensione	t3 = preignition time
Ph40	TSA1 = primo tempo sicurezza (trasformatore accensione ON)	TSA1= 1st safety time (ignition transformer ON)
Ph42	TSA1 = primo tempo sicurezza (trasformatore accensione OFF)	TSA1 = 1st safety time (ignition transformer OFF) t42 = preignition time OFF
Ph44	t44 = intervallo 1	t44 = interval 1
Ph50	TSA2 = secondo tempo sicurezza	TSA2 = 2nd safety time
Ph52	t52 = intervallo 2	t52 = interval 2
Ph60	Funzionamento 1 (stazionario)	Operation 1 (stationary)
Ph62	t62 = massimo tempo bassa fiamma (funzionamento 2, in preparazione per spegnimento, verso bassa fiamma)	t62 = max. time low-fire (operation 2, preparing for shutdown, traveling to low-fire)
Ph70	t13 = tempo postcombustione	t13 = afterburn time
Ph72	Verso posizione postcombustione	Traveling to the postpurge position
Ph74	t8 = tempo postventilazione	t8 = postpurge time
Ph80	t80 = tempo evacuazione controllo tenuta valvole	t80 = valve proving test evacuation time
Ph81	t81 = tempo perdita pressione atmosferica, prova atmosferica	t81 = leakage time test time atmospheric pressure, atmospheric test
Ph82	t82 = test perdita, test riempimento	t82 = leakage test filling test, filling
Ph83	t83 = tempo perdita pressione gas, test pressione	t83 = leakage test time gas pressure, pressure test
Ph90	Tempo attesa "mancanza gas"	Gas shortage waiting time

### Entering the Parameter levels

By means of a proper use of the keys, it is possible to enter the various level parameters, as shown in the following flow chart:

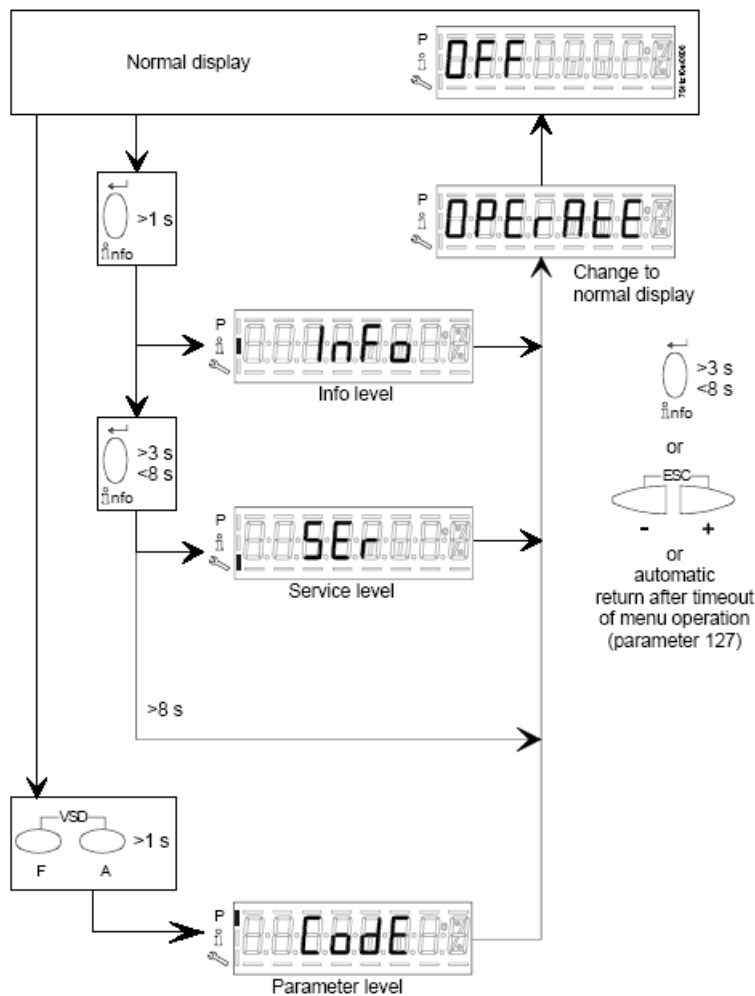

The burner and consequently the LMV2x.. are factory set; the air and fuel curves as set as well.

### Info level

To enter the **Info** level, proceed as follows:

- 1 in any menu position, press keys + and - at the same time, then the program will start again: the display will show **OFF**.



- 2 until the display will show **InFo**, Press the **enter (InFo)** key



- 3 then it will show the first code (167) flashing, on the right side it will show the data entered. By pressing + or - it is possible to scroll (up or down) the parameter list.
- 4 If a dot-line is shown on the right, there is not enough room for complete visualization: press **enter** again the data will be completely shown for 1 to 3 seconds. By pressing **enter** or + and- at the same time, the system will exit the parameter visualization and go back to the flashing number.

The **Info** level shows some basic parameters as:

Parameter	Description
167	Cubic meters of fule (resettable)
162	Operating hours (resettable)
163	Device operating hours
164	Burners start-ups (resettable)
166	Total number of start-ups
113	Burner number (i.e. serial number)
107	Software version
102	Software date
103	Device serial number
104	Customer code
105	Version
143	Free

5 Example: choose parameter 102 to show the date

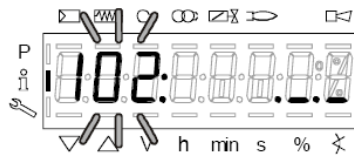

the display shows parameter **102** flashing on the left and characters **. \_ \_** on the right.

6 press InFo for 1-3 seconds: the date will appear

7 press InFo to go back to parameter "102"

8 by pressing + / -, it is possible to scroll up/down the parameter list (see table above), or, by pressing ESC or InFo for more seconds, the display will show

9 Once the last parameter is accessed (143) by pressing + , the **End** message will flash.

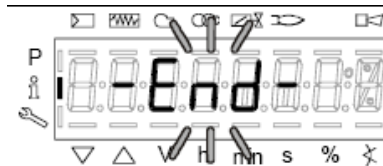

10 Press **InFo** for more than three seconds or for more than three seconds orto return to the normal display.



If a message like the one below is shown during operation,

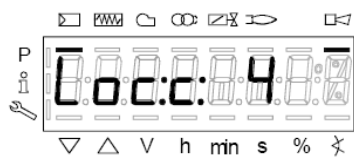

it means that the burner is locked out and the Errore code is shown (in the example "error code:4"); this message is alternating with another message



Diagnostic code (in the example “diagnostic code:3”). Record the codes and find out the fault in the Error table. To perform the reset, press InFo for one second:



The unit displays an event which does not lead to shutdown. The display shows current error code **c**: alternating with diagnostic code **d**:



Press **InFo** to return to the display of phases. Example: Error code **111** / diagnostic code **0**



To reset, press InFo for a second. Record the codes and check the Error List to find the type of faults.

**Service level**

To enter the Service mode, press InFo until the display will show:



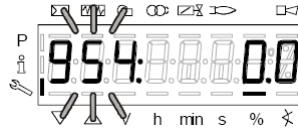

The service level shows all the information about flame intensity, actuators position, number and lock codes:

Parameter	Description
954	Flame intensity
121	% output, if set = automatic operation
922	Actuators position, 00=combustibile; 01= aria
161	Lock-outs number
701..725	Lock-outs History (see chapter 23 in the LMV2x manual)

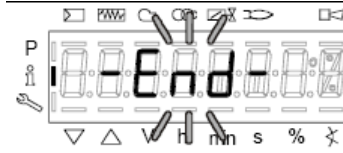

- 1 .the first parameter will be "954": the percentage of flame is shown on the right. By pressing + or - it is possible to scroll up/down the parameter list.
- 2 Once the last parameter is accessed (143) by pressing + , the **End** message will blink.



- 3 Press **InFo**  for more than three seconds or for more than three seconds orto return to the normal display.



For further nformation, see tha LMV2 related manual.

**Adjustment procedure for light oil operation**

- 1 Open the electrical panel to check the motor rotation and act directly on its contactor (see next picture): keep pressed until the oil circuit is charged.

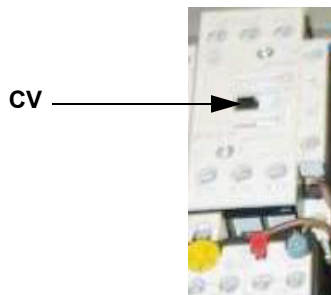

- 2 bleed the air from the **M** pressure gauge port (Fig. 11) by loosening the cap without removing it, then release the contactor.

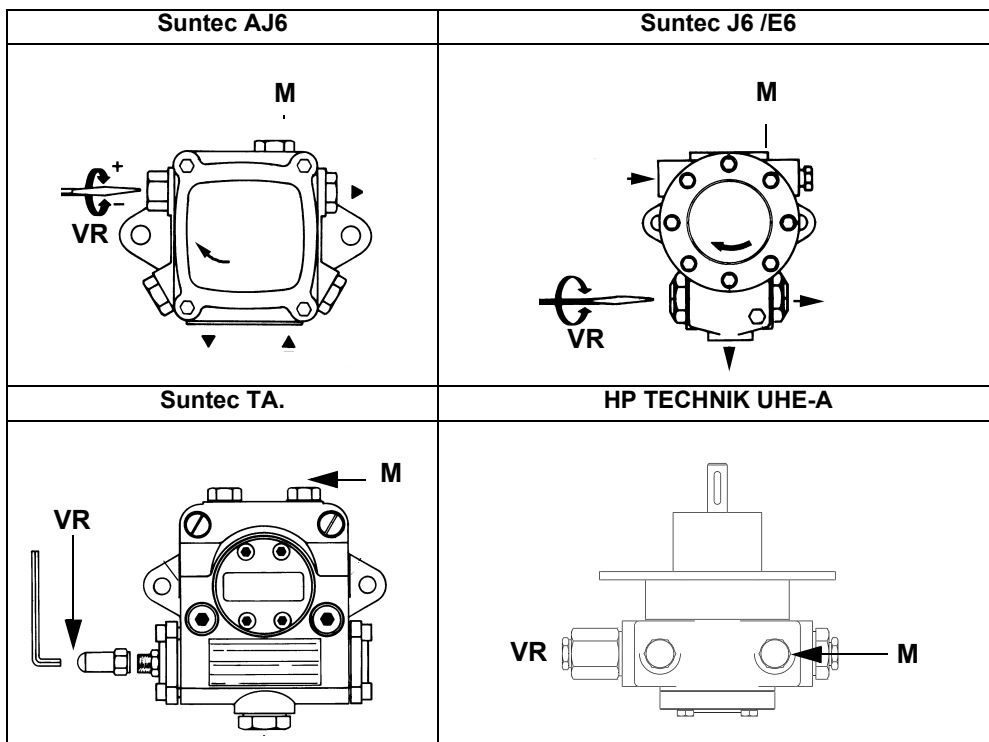

Fig. 11

- 3 As for setting the fuel/air ratio curve, see the LMV related manual.
- 4 Fig. 12 Fig. 13 the nozzle supply pressure is already factory-set and must not be changed. Only if necessary, adjust the supply pressure as follows (see related paragraph); insert a pressure gauge into the port shown on Fig. 12-Fig. 13 and act on the pump adjusting screw **VR** (see Fig. 11) as to get the nozzle pressure at 20bar (Bergonzo nozzles - see diagram on Fig. 10).

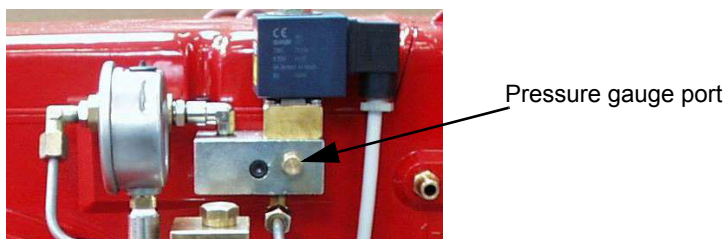

Fig. 12 - Light oil manifold (PG60)

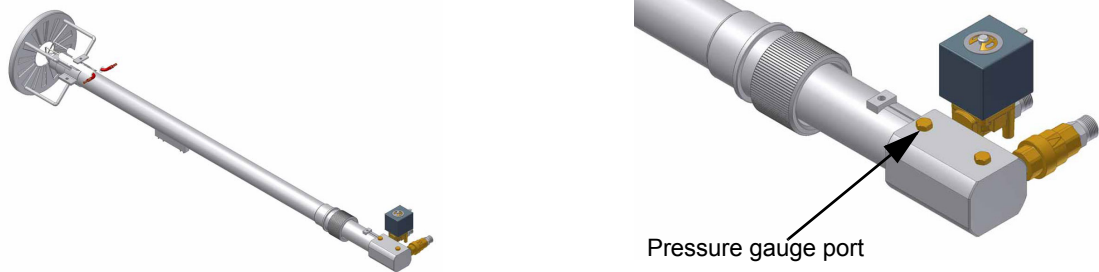

Fig. 13 - Combustion head with light oil gun  
(PG70 - PG81)

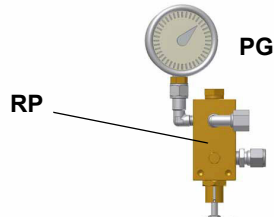

Fig. 14

5 in order to get the maximum oil flow rate, adjust the pressure (reading its value on the **PG** pressure gauge): checking always the combustion parameters

6 The burner is factory-set with the head in its **MAX** position (maximum output).

**PG60:**

To let the burner operate at a lower output, turn clockwise the **VRT** screw and move progressively the combustion head back towards the **MIN** position.

**PG70-PG81:**

To let the burner operate at a lower output, loose the **VB** screw and move progressively the combustion head back towards the **MIN** position, by turning clockwise the **VRT** ring nut. Fasten **VB** screw when the adjustment is accomplished.

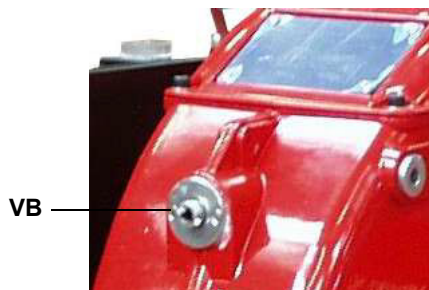

PG60

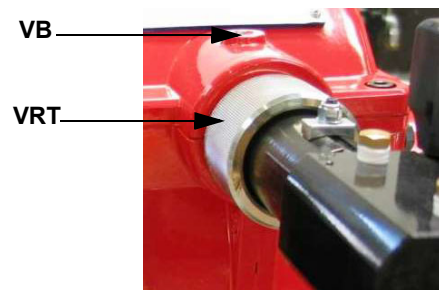

PG70-PG81

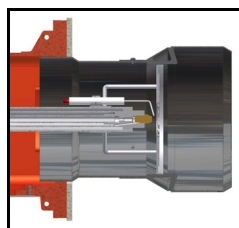

"MIN" position

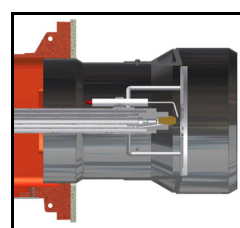

"MAX" position

**Attention!** if it is necessary to change the head position, repeat the air and gas adjustments described above.

Turn the burner off; then start it up again. If the adjustment is not correct, repeat the previous steps.

### Maximum oil pressure switch

The oil pressure switch on the return line, checks that the pressure does not exceed a default value. This value must not be higher than the maximum acceptable pressure on the return line (this value is reported on the specification table). A pressure change on the return line could affect the combustion parameters: for this reason, the pressure switch must be set, say, at 20% over the pressure recorded during the combustion adjustment. The factory setting is 4 bar.

It is recommended to verify that the combustion parameters are within the range of acceptable values even against a pressure variation that gets close to the limit of the pressure switch.

This check should be carried out along the whole range of the burner output.

In case of unacceptable values, reduce from 20% to 15% the overpressure; later on, repeat the adjustments described above.

### Minimum oil pressure switch (when provided)

The minimum oil pressure switch on the inlet line, checks that the pressure does not drop below a default value. The pressure switch must be set, say, at 10% under the pressure at the nozzle.

### Oil pressure switch adjustment

Follow the below instruction, according to the pressure switch installed.

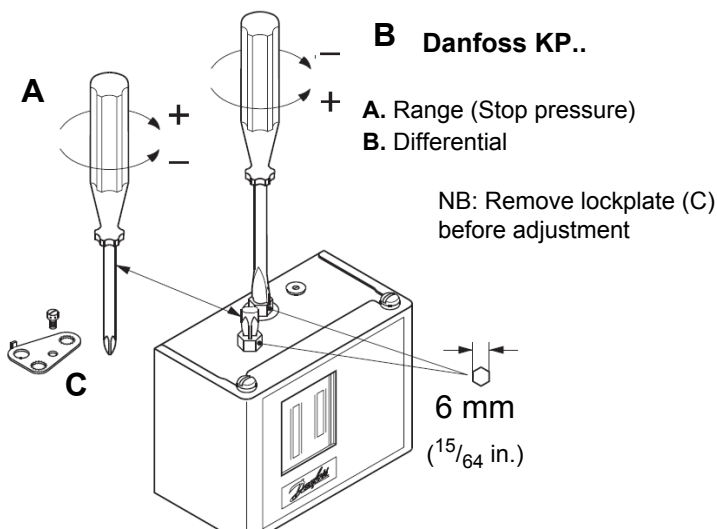

### Trafag Picostat 9B4..

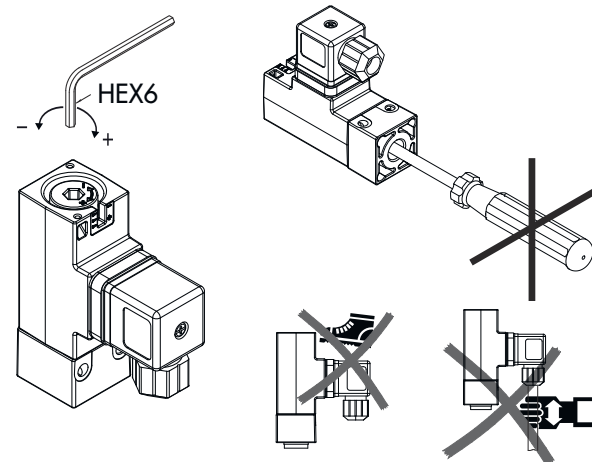

### Fully-modulating burners

To adjust the fully-modulating burners, use the **CMF** switch on the burner control panel (see next picture), instead of the **TAB** thermostat as described on the previous paragraphs about the progressive burners. Go on adjusting the burner as described before, paying attention to use the **CMF** switch instead of **TAB**.

The **CMF** position sets the operating stages: to drive the burner to the high-flame stage, set **CMF**=1; to drive it to the low-flame stage, set **CMF**=2.

To move the adjusting cam set **CMF**=1 or 2 and then **CMF**=0.

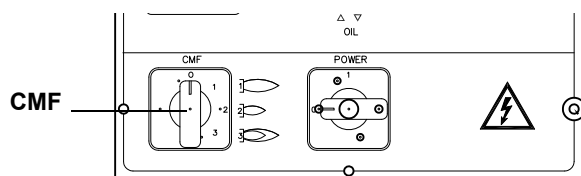

- CMF = 0 stop at the current position
- CMF = 1 high flame operation
- CMF = 2 low flame operation
- CMF = 3 automatic operation

### Calibration of air pressure switch (when provided)

To calibrate the air pressure switch, proceed as follows:

- Remove the transparent plastic cap.
- Once air and gas setting have been accomplished, startup the burner.
- During the pre-purge phase of the operation, turn slowly the adjusting ring nut **VR** in the clockwise direction (to increase the adjusting pressure) until the burner locks out, then read the value on the pressure switch scale and set it to a value reduced by 15%.
- Repeat the ignition cycle of the burner and check it runs properly.
- Refit the transparent plastic cover on the pressure switch.

## PART II: OPERATION

## LIMITATIONS OF USE

THE BURNER IS AN APPLIANCE DESIGNED AND CONSTRUCTED TO OPERATE ONLY AFTER BEING CORRECTLY CONNECTED TO A HEAT GENERATOR (E.G. BOILER, HOT AIR GENERATOR, FURNACE, ETC.), ANY OTHER USE IS TO BE CONSIDERED IMPROPER AND THEREFORE DANGEROUS.

THE USER MUST GUARANTEE THE CORRECT FITTING OF THE APPLIANCE, ENTRUSTING THE INSTALLATION OF IT TO QUALIFIED PERSONNEL AND HAVING THE FIRST COMMISSIONING OF IT CARRIED OUT BY A SERVICE CENTRE AUTHORIZED BY THE COMPANY MANUFACTURING THE BURNER.

A FUNDAMENTAL FACTOR IN THIS RESPECT IS THE ELECTRICAL CONNECTION TO THE GENERATOR'S CONTROL AND SAFETY UNITS (CONTROL THERMOSTAT, SAFETY, ETC.) WHICH GUARANTEES CORRECT AND SAFE FUNCTIONING OF THE BURNER.

THEREFORE, ANY OPERATION OF THE APPLIANCE MUST BE PREVENTED WHICH DEPARTS FROM THE INSTALLATION OPERATIONS OR WHICH HAPPENS AFTER TOTAL OR PARTIAL TAMPERING WITH THESE (E.G. DISCONNECTION, EVEN PARTIAL, OF THE ELECTRICAL LEADS, OPENING THE GENERATOR DOOR, DISMANTLING OF PART OF THE BURNER).

NEVER OPEN OR DISMANTLE ANY COMPONENT OF THE MACHINE.

OPERATE ONLY THE MAIN SWITCH, WHICH THROUGH ITS EASY ACCESSIBILITY AND RAPIDITY OF OPERATION ALSO FUNCTIONS AS AN EMERGENCY SWITCH, AND ON THE RESET BUTTON.

IN CASE OF A BURNER SHUT-DOWN, RESET THE CONTROL BOX BY MEANS OF THE RESET PUSHBUTTON. IF A SECOND SHUT-DOWN TAKES PLACE, CALL THE TECHNICAL SERVICE, WITHOUT TRYING TO RESET FURTHER.

**WARNING:** DURING NORMAL OPERATION THE PARTS OF THE BURNER NEAREST TO THE GENERATOR (COUPLING FLANGE) CAN BECOME VERY HOT, AVOID TOUCHING THEM SO AS NOT TO GET BURNT.

## OPERATION



**ATTENTION:** before starting the burner up, be sure that the manual cutoff valves are open and check that the mains switch is closed.

- 1 Set to the ON position the switch A on the control panel of the burner.
- 2 Check the control box is not in the lockout position (light **B** must be off); in such a case reset it by the AZLx.
- 3 Check the series of thermostats (or pressure switches) sends the burner the signal to operate.
- 4 The startup sequence begins: the control box ignites the fan motor and energises the ignition transformer as well (signalled by the light **H** on the burner control panel).
- 5 At the end of the pre-purge stage, the light oil solenoid valve EVG1 is energised (signalled by the lamp **G** on the control panel) and the burner is on.
- 6 The ignition transformer is energized for few seconds after the ignition of the flame (post-ignition time) and at the end of this time is de-energised (light **H** off).
- 7 After the ignition the servocontrol moves to the high flame position for some seconds, then the operation begins and the burner switches to high flame or to low flame, according to the plant demand.
- 8 The high/low flame operation is showed by the **F** LED turning on/off.

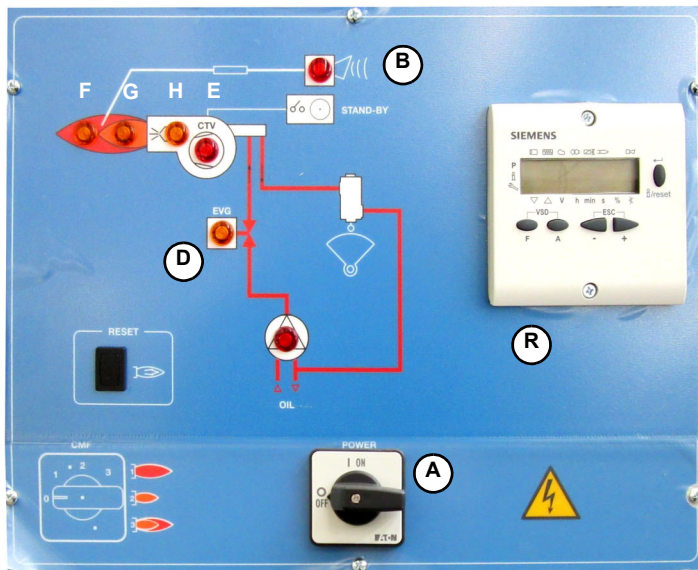
**Burner control panel****Keys**

- A ON-OFF main switch
- B Lockout signalling lamp
- D Signalling lamp for light oil solenoid valve opening
- E Thermal cutout intervention signalling lamp
- F High flame operation signalling lamp
- G Low flame operation signalling lamp
- H Ignition transformer operation signalling lamp
- R AZLx

## PART III: MAINTENANCE

At least once a year carry out the maintenance operations listed below. In the case of seasonal servicing, it is recommended to carry out the maintenance at the end of each heating season; in the case of continuous operation the maintenance is carried out every 6 months.



**WARNING: ALL OPERATIONS ON THE BURNER MUST BE CARRIED OUT WITH THE MAINS DISCONNECTED AND THE FUEL MANUAL CUTOFF VALVES CLOSED!**  
**ATTENTION: READ CAREFULLY THE "WARNINGS" CHAPTER AT THE BEGINNING OF THIS MANUAL.**

## ROUTINE MAINTENANCE

- Check and clean the cartridge of the fuel filter, replace it if necessary (see next paragraph);
- carefully check for leaks, the fuel flexible hoses;
- check and clean the filter on the fuel pump: filter must be thoroughly cleaned at least once in a season to ensure correct working of the fuel unit. To remove the filter, unscrew the four screws on the cover. When reassemble, make sure that the filter is mounted with the feet toward the pump body. If the gasket between cover and pump housing should be damaged, it must be replaced;
- remove, check and clean the combustion head (page 37); when reassembling, carefully observe the measures on page 37;
- check the ignition electrodes and their ceramic insulators, clean, adjust and replace if necessary;
- remove and clean the oil nozzles (IMPORTANT: do not clean the nozzles using metallic or sharp utensils, use only solvents or steam); at the end of maintenance operations, refit the burner, turn it on and check the combustion. If in doubt, replace the defective nozzle/s. In case of intensive use of the burner, the nozzles must be replaced at the end of the working season;
- check and carefully clean the flame detection photoresistor, if necessary replace it and, if in doubt, check the detection current ;
- clean and grease levers and rotating parts.

### ***Light oil filter maintenance***

For correct and proper servicing, proceed as follows:

- 1 shut off fuel in the line section being serviced;
- 2 unscrew the tray;
- 3 remove the filter cartridge from its support and wash it with petrol or replace if necessary; check seal O-Ring, replace if necessary;
- 4 reassemble the tray and restore fuel flow.



### Removing the combustion head and the oil gun

- 1 Remove the top cover **C**;
- 2 remove the photoresistor from its seat;
- 3 unscrew the revolving connectors (**E** in figure) on the fuel pipes (use 2 spanners to avoid loosening the connections attached to the distributor block);
- 4 loosen **VRT** screw to free the threaded rod **AR**, then screw out the 2 screws **V** holding the washer **R** and the screw **VRT** again;
- 5 remove the whole assembly as shown in the pictures;
- 6 clean the combustion head and the oil gun by means of a vacuum cleaner; to scrape off the scale use a metallic brush.

Note: to replace the combustion head reverse the procedure described above.

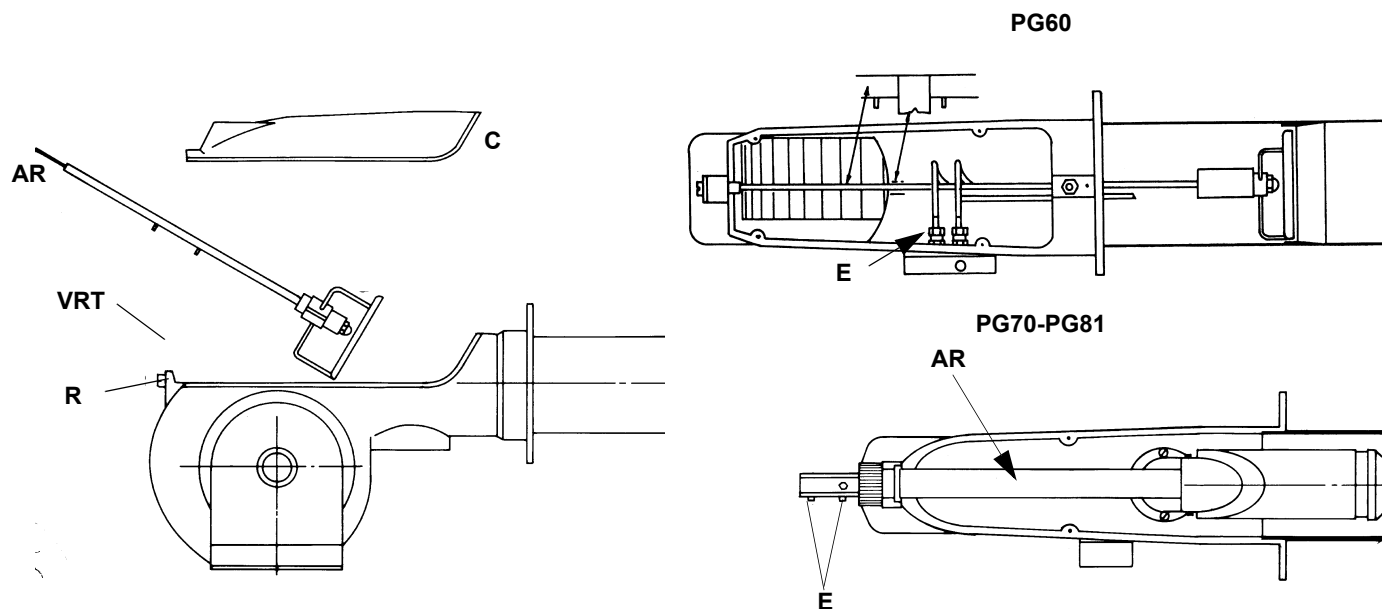

Fig. 15

### Removing the oil gun (PG70-PG81)

Once the combustion head is removed, as described before, remove the oil gun as follows:

- 1 unscrew the connectors from the 2 oil pipes (**E** in figure) using 2 spanners to avoid loosening the connections attached to the distributor block);
- 2 loosen the screw **VB**
- 3 remove the gun with the light oil nozzle holder.
- 4 clean the oil gun by means of a vacuum cleaner; to scrape off the scale use a metallic brush
- 5 replace the oil gun, if necessary.

Note: To re-assemble, follow the procedure above in reversed order.

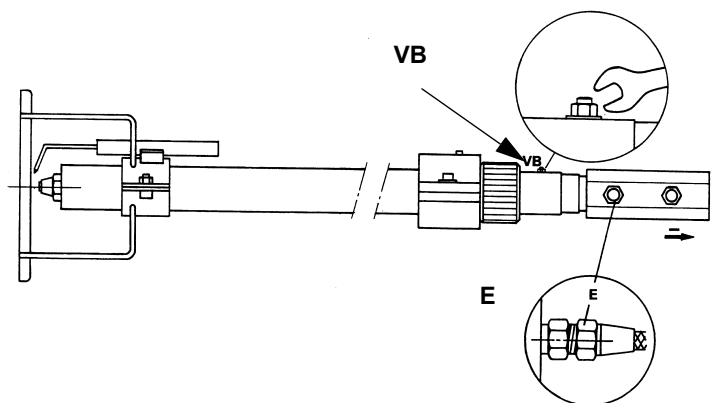

Fig. 16

### Correct position of electrodes and combustion head



**ATTENTION:** avoid the electrodes to get in touch with metallic parts (blast tube, head, etc.), otherwise the boiler operation would be compromised. Check the electrodes position after any intervention on the combustion head.

To guarantee a good ignition the measures shown on the next picture Fig. 17 must be observed.  
Be sure to tight the screw on the electrodes group before reassembling the combustion head.

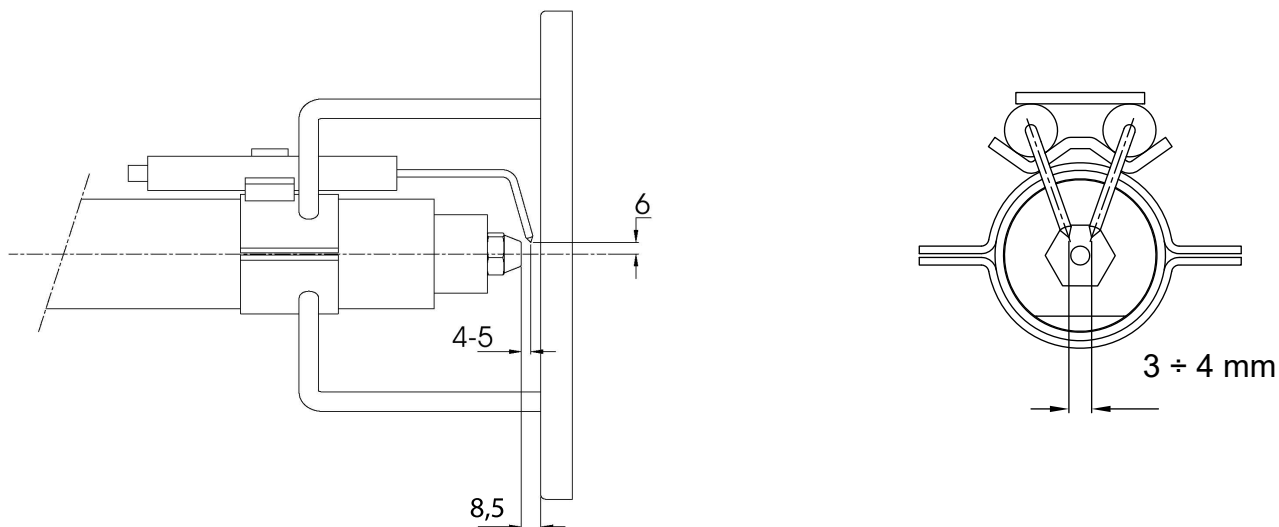

Fig. 17

### Replacing the ignition electrodes



**ATTENTION:** avoid the electrodes to get in touch with metallic parts (blast tube, head, etc.), otherwise the boiler operation would be compromised. Check the electrodes position after any intervention on the combustion head.

To replace the ignition electrodes, proceed as follows:

- 1 remove the burner cover;
- 2 disconnect the electrodes cables;
- 3 remove the combustion head (see par. "Removing the combustion head");
- 4 loose screw that fasten the ignition electrodes;
- 5 remove the electrodes and replace them, referring to the values quoted on Fig. 17.

### Cleaning and replacing the detection photoresistor

To clean/replace the photoresistor, proceed as follows:

- 1 disconnect the system from the electrical power supply;
- 2 shut off the fuel supply;
- 3 remove the photoresistor from its slot;
- 4 clean it using a clean cloth; do not use any burner cleansing sprays;
- 5 if necessary, replace it;
- 6 insert the photoresistor into its slot.

### Checking the detection current

To check the detection signal follow the scheme in the picture below. If the signal is less than the value indicated, check the position of the detection electrode or detector, the electrical contacts and, if necessary, replace the electrode or the detector.

Device	Flame detector	Minimum detection signal
Siemens LMV2x/3x	QRB4	Flame intensity (parameter 954) >16%

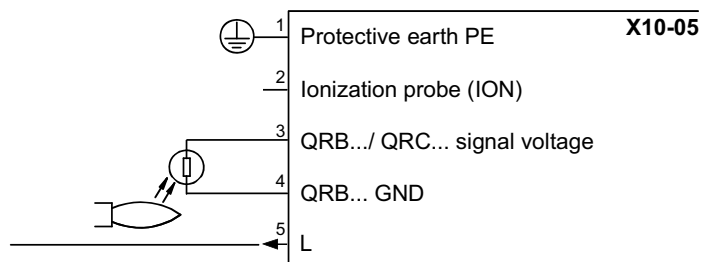

#### Seasonal stop

To stop the burner in the seasonal stop, proceed as follows:

- 1 turn the burner's main switch to 0 (Off position)
- 2 disconnect the power mains
- 3 close the fuel manual valve of the supply line

### Burner disposal

In case of disposal, follow the instructions according to the laws in force in your country about the "Disposal of materials".

## TROUBLESHOOTING

	THE BURNER DOESN'T START	THE BURNER REPEATS PRE-PURGE	NOISY FUEL PUMP	THE BURNER DOESN'T START AND STOPS	THE BURNER STARTS AND STOPS	THE BURNER DOESN'T SWITCH TO HIGH FLAME	THE BURNER STOPS DURING OPERATION	THE BURNER STOPS AND REPEATS THE CYCLE DURING OPERATION
MAIN SWITCH OPEN	●							
LINE FUSE INTERVENTION	●							
MAX. PRESSURE SWITCH FAULT	●							●
FAN THERMAL CUTOUT INTERVENTION	●							
AUXILIARY RELAIS FUSES INTERVENTION	●							
CONTROL BOX FAULT	●	●		●	●		●	
SERVOCONTROL FAULT						●		
SMOKEY FLAME					●		●	
IGNITION TRANSFORMER FAULT				●				
IGNITION ELECTRODE DIRTY OR WRONG POSITIONED				●				
DIRTY NOZZLE				●			●	
FUEL SOLENOID VALVE DEFECTIVE				●			●	
PHOTORESISTOR DIRTY OR DEFECTIVE					●		●	
HI-LO FLAME THERMOSTAT DEFECTIVE						●		
WRONG POSITION OF SERVOCONTROL CAMS						●		
FUEL PRESSURE TOO LOW				●				
DIRTY FUEL FILTERS			●	●			●	

## WIRING DIAGRAMS

Refer to the attached wiring diagrams.

**WARNING**

- 1 - Electrical supply 230V 50Hz 1 a.c./400V 50Hz 3N a.c.
- 2 - Do not reverse phase with neutral
- 3 - Ensure burner is properly earthed







C.I.B. UNIGAS S.p.A.  
Via L.Galvani, 9 - 35011 Campodarsego (PD) - ITALY  
Tel. +39 049 9200944 - Fax +39 049 9200945/9201269  
web site: [www.cibunigas.it](http://www.cibunigas.it) - e-mail: [cibunigas@cibunigas.it](mailto:cibunigas@cibunigas.it)

Note: specifications and data subject to change. Errors and omissions excepted.

# ***AZL2x - LMV2x/3x Burner Management System***



## ***Service manual***

---

## INDEX

<i>MICROPROCESSOR CONTROLLED SYSTEM</i> .....	6
<i>User interface</i> .....	6
<i>Parameters level (heating engineer)</i> .....	8
<i>Setting menu</i> .....	9
<i>Block 000: Internal Parameter</i> .....	10
<i>Block 100: General information</i> .....	10
<i>Block 200: Burner control</i> .....	13
<i>Block 400: Setting air/fuel ratio curves</i> .....	25
<i>Block 500: Air/fuel ratio control</i> .....	26
<i>Block 600: Actuators</i> .....	28
<i>Block 700: Error history</i> .....	31
<i>Block 900: Process data</i> .....	32
<i>Actuators references</i> .....	33
<i>Gas proving system</i> .....	33
<i>Air-fuel curve points</i> .....	33
<i>COMMISSIONING THE BURNER</i> .....	34
<i>Warm setting</i> .....	38
<i>Cold setting</i> .....	39
<i>BURNER STARTUP WITH LMV2x ALREADY PROGRAMMED</i> .....	40
<i>Reset / manual lockout</i> .....	42
<i>Timeout for menu operation</i> .....	42
<i>Entering the Parameter levels</i> .....	43
<i>Info level</i> .....	44
<i>Service level</i> .....	46
<i>PHASES LIST</i> .....	47
<i>BACKUP PARAMETER WITH AZL2x</i> .....	48
<i>RESTORE PARAMETER FROM AZL2x TO LMV.</i> .....	49
<i>WIRING DIAGRAM</i> .....	65
<i>Wiring connection for LMV20</i> .....	65
<i>Wiring variants for LMV27</i> .....	66
<i>Wiring variants for LMV26</i> .....	67
<i>Wiring variants for LMV37</i> .....	68

## DANGERS, WARNINGS AND NOTES OF CAUTION

**THIS MANUAL IS SUPPLIED AS AN INTEGRAL AND ESSENTIAL PART OF THE PRODUCT AND MUST BE DELIVERED TO THE USER.**

**INFORMATION INCLUDED IN THIS SECTION ARE DEDICATED BOTH TO THE USER AND TO PERSONNEL FOLLOWING PRODUCT INSTALLATION AND MAINTENANCE.**

**THE USER WILL FIND FURTHER INFORMATION ABOUT OPERATING AND USE RESTRICTIONS, IN THE SECOND SECTION OF THIS MANUAL. WE HIGHLY RECOMMEND TO READ IT.**

**CAREFULLY KEEP THIS MANUAL FOR FUTURE REFERENCE.**

### 1) GENERAL INTRODUCTION

- The equipment must be installed in compliance with the regulations in force, following the manufacturer's instructions, by qualified personnel.
- Qualified personnel means those having technical knowledge in the field of components for civil or industrial heating systems, sanitary hot water generation and particularly service centres authorised by the manufacturer.
- Improper installation may cause injury to people and animals, or damage to property, for which the manufacturer cannot be held liable.
- Remove all packaging material and inspect the equipment for integrity.

In case of any doubt, do not use the unit - contact the supplier.

The packaging materials (wooden crate, nails, fastening devices, plastic bags, foamed polystyrene, etc), should not be left within the reach of children, as they may prove harmful.

- Before any cleaning or servicing operation, disconnect the unit from the mains by turning the master switch OFF, and/or through the cut-out devices that are provided.
- Make sure that inlet or exhaust grilles are unobstructed.
- In case of breakdown and/or defective unit operation, disconnect the unit. Make no attempt to repair the unit or take any direct action.

Contact qualified personnel only.

Units shall be repaired exclusively by a servicing centre, duly authorised by the manufacturer, with original spare parts.

Failure to comply with the above instructions is likely to impair the unit's safety.

To ensure equipment efficiency and proper operation, it is essential that maintenance operations are performed by qualified personnel at regular intervals, following the manufacturer's instructions.

- When a decision is made to discontinue the use of the equipment, those parts likely to constitute sources of danger shall be made harmless.
- In case the equipment is to be sold or transferred to another user, or in case the original user should move and leave the unit behind, make sure that these instructions accompany the equipment at all times so that they can be consulted by the new owner and/or the installer.
- For all the units that have been modified or have options fitted then original accessory equipment only shall be used.
- This unit shall be employed exclusively for the use for which it is meant. Any other use shall be considered as improper and, therefore, dangerous.

The manufacturer shall not be held liable, by agreement or otherwise, for damages resulting from improper installation, use and failure to comply with the instructions supplied by the manufacturer. The occurrence of any of the following circumstances may cause explosions, polluting unburnt gases (example: carbon monoxide CO), burns, serious harm to people, animals and things:

- Failure to comply with one of the WARNINGS in this chapter
- Incorrect handling, installation, adjustment or maintenance of the burner
- Incorrect use of the burner or incorrect use of its parts or optional supply

### 2) SPECIAL INSTRUCTIONS FOR BURNERS

- The burner should be installed in a suitable room, with ventilation openings complying with the requirements of the regulations in force, and sufficient for good combustion.
- Only burners designed according to the regulations in force should be used.
- This burner should be employed exclusively for the use for which it

was designed.

- Before connecting the burner, make sure that the unit rating is the same as delivery mains (electricity, gas oil, or other fuel).
- Observe caution with hot burner components. These are, usually, near to the flame and the fuel pre-heating system, they become hot during the unit operation and will remain hot for some time after the burner has stopped.

When the decision is made to discontinue the use of the burner, the user shall have qualified personnel carry out the following operations:

- a Remove the power supply by disconnecting the power cord from the mains.
- b Disconnect the fuel supply by means of the hand-operated shut-off valve and remove the control handwheels from their spindles.

#### Special warnings

- Make sure that the burner has, on installation, been firmly secured to the appliance, so that the flame is generated inside the appliance firebox.
- Before the burner is started and, thereafter, at least once a year, have qualified personnel perform the following operations:
  - a set the burner fuel flow rate depending on the heat input of the appliance;
  - b set the flow rate of the combustion-supporting air to obtain a combustion efficiency level at least equal to the lower level required by the regulations in force;
  - c check the unit operation for proper combustion, to avoid any harmful or polluting unburnt gases in excess of the limits permitted by the regulations in force;
  - d make sure that control and safety devices are operating properly;
  - e make sure that exhaust ducts intended to discharge the products of combustion are operating properly;
  - f on completion of setting and adjustment operations, make sure that all mechanical locking devices of controls have been duly tightened;
  - g make sure that a copy of the burner use and maintenance instructions is available in the boiler room.
- In case of a burner shut-down, reset the control box by means of the RESET pushbutton. If a second shut-down takes place, call the Technical Service, **without trying to RESET further**.
- The unit shall be operated and serviced by qualified personnel only, in compliance with the regulations in force.

### 3) GENERAL INSTRUCTIONS DEPENDING ON FUEL USED

#### 3a) ELECTRICAL CONNECTION

- For safety reasons the unit must be efficiently earthed and installed as required by current safety regulations.
- It is vital that all safety requirements are met. In case of any doubt, ask for an accurate inspection of electricians by qualified personnel, since the manufacturer cannot be held liable for damages that may be caused by failure to correctly earth the equipment.
- Qualified personnel must inspect the system to make sure that it is adequate to take the maximum power used by the equipment shown on the equipment rating plate. In particular, make sure that the system cable cross section is adequate for the power absorbed by the unit.
- No adaptors, multiple outlet sockets and/or extension cables are permitted to connect the unit to the electric mains.
- An omnipolar switch shall be provided for connection to mains, as required by the current safety regulations.
- The use of any power-operated component implies observance of a few basic rules, for example:
  - do not touch the unit with wet or damp parts of the body and/or with bare feet;
  - do not pull electric cables;

- do not leave the equipment exposed to weather (rain, sun, etc.) unless expressly required to do so;
  - do not allow children or inexperienced persons to use equipment;
  - The unit input cable shall not be replaced by the user.
- In case of damage to the cable, switch off the unit and contact qualified personnel to replace.

When the unit is out of use for some time the electric switch supplying all the power-driven components in the system (i.e. pumps, burner, etc.) should be switched off.

### 3b) FIRING WITH GAS, LIGHT OIL OR OTHER FUELS

#### GENERAL

- The burner shall be installed by qualified personnel and in compliance with regulations and provisions in force; wrong installation can cause injuries to people and animals, or damage to property, for which the manufacturer cannot be held liable.
- Before installation, it is recommended that all the fuel supply system pipes be carefully cleaned inside, to remove foreign matter that might impair the burner operation.
- Before the burner is commissioned, qualified personnel should inspect the following:
  - a the fuel supply system, for proper sealing;
  - b the fuel flow rate, to make sure that it has been set based on the firing rate required of the burner;
  - c the burner firing system, to make sure that it is supplied for the designed fuel type;
  - d the fuel supply pressure, to make sure that it is included in the range shown on the rating plate;
  - e the fuel supply system, to make sure that the system dimensions are adequate to the burner firing rate, and that the system is equipped with all the safety and control devices required by the regulations in force.
- When the burner is to remain idle for some time, the fuel supply tap or taps should be closed.

#### SPECIAL INSTRUCTIONS FOR USING GAS

Have qualified personnel inspect the installation to ensure that:

- a the gas delivery line and train are in compliance with the regulations and provisions in force;
  - b all gas connections are tight;
  - c the boiler room ventilation openings are such that they ensure the air supply flow required by the current regulations, and in any case are sufficient for proper combustion.
- Do not use gas pipes to earth electrical equipment.
  - Never leave the burner connected when not in use. Always shut the gas valve off.
  - In case of prolonged absence of the user, the main gas delivery valve to the burner should be shut off.

#### Precautions if you can smell gas

- a do not operate electric switches, the telephone, or any other item likely to generate sparks;
  - b immediately open doors and windows to create an air flow to purge the room;
  - c close the gas valves;
  - d contact qualified personnel.
- Do not obstruct the ventilation openings of the room where gas appliances are installed, to avoid dangerous conditions such as the development of toxic or explosive mixtures.

## DIRECTIVES AND STANDARDS

### Gas burners

#### European directives:

- Directive 2009/142/EC - Gas Appliances;
- Directive 2006/95/EC on low voltage;
- Directive 2004/108/EC on electromagnetic compatibility

#### Harmonised standards :

- UNI EN 676 (Gas Burners;-EN 55014-1Electromagnetic compatibility - Requirements for household appliances, electric tools and similar apparatus.
- CEI EN 60335-1(Household and similar electrical appliances - Safety. Part 1: General requirements;
- EN 50165 (Electrical equipment of non-electric appliances for household and similar purposes. Safety requirements.
- EN 60335-2-102 (Household and similar electrical appliances. Safety. Particular requirements for gas, oil and solid-fuel burning appliances having electrical connections)

### Light oil burners

#### European directives:

- Directive 2006/95/EC on low voltage;
- Directive 2004/108/EC on electromagnetic compatibility

#### Harmonised standards :

- CEI EN 60335-1(Household and similar electrical appliances - Safety. Part 1: General requirements;
- UNI 267 Automatic forced draught burners for liquid fuels
- EN 55014-1Electromagnetic compatibility - Requirements for household appliances, electric tools and similar apparatus.
- EN 50165 (Electrical equipment of non-electric appliances for household and similar purposes. Safety requirements.

#### National standards :

- UNI 7824: Monobloc nebulizer burners for liquid fuels. Characteristics and test methods

### Heavy oil burners

#### European directives:

- Directive 2006/95/EC on low voltage;
- Directive 2004/108/EC on electromagnetic compatibility

#### Harmonised standards :

- CEI EN 60335-1 Household and similar electrical appliances - SafetyPart 1: General requirements;
- EN 55014-1Electromagnetic compatibility - Requirements for household appliances, electric tools and similar apparatus.
- EN 50165 Electrical equipment of non-electric appliances for household and similar purposes. Safety requirements.

#### National standards :

- UNI 7824: Monobloc nebulizer burners for liquid fuels. Characteristics and test methods

### Gas - Light oil burners

#### European directives:

- Directive 2009/142/EC - Gas Appliances;
- Directive 2006/95/EC on low voltage;
- Directive 2004/108/EC on electromagnetic compatibility

#### Harmonised standards :

- UNI EN 676 Gas Burners
- EN 55014-1Electromagnetic compatibility - Requirements for household appliances, electric tools and similar apparatus.
- UNI 267 Automatic forced draught burners for liquid fuels
- CEI EN 60335-1(Household and similar electrical appliances - Safety. Part 1: General requirements;
- EN 50165 Electrical equipment of non-electric appliances for household and similar purposes. Safety requirements.

#### National standards :

- UNI 7824: Monobloc nebulizer burners for liquid fuels. Characteristics and test methods

### Gas - Heavy oil burners

#### European directives:

- Directive 2009/142/EC - Gas Appliances;
- Directive 2006/95/EC on low voltage;
- Directive 2004/108/EC on electromagnetic compatibility

#### Harmonised standards :

-EN 55014-1 Electromagnetic compatibility - Requirements for household appliances, electric tools and similar apparatus.

-UNI EN 676 (Gas Burners;

-CEI EN 60335-1 (Household and similar electrical appliances - Safety. Part 1: General requirements;

- EN 50165 Electrical equipment of non-electric appliances for household and similar purposes. Safety requirements.

**National standards :**

-UNI 7824: Monobloc nebulizer burners for liquid fuels. Characteristics and test methods

**Industrial burners**

**European directives:**

- Directive 2009/142/EC - Gas Appliances;

- Directive 2006/95/EC on low voltage;

- Directive 2004/108/EC on electromagnetic compatibility

**Harmonised standards :**

-EN 55014-1 Electromagnetic compatibility - Requirements for household appliances, electric tools and similar apparatus.

-EN 50165 Electrical equipment of non-electric appliances for household and similar purposes. Safety requirements.

-UNI EN 746-2: Industrial thermoprocessing equipment

**Burner data plate**

For the following information, please refer to the data plate:

- burner type and burner model: must be reported in any communication with the supplier
- burner ID (serial number): must be reported in any communication with the supplier
- date of production (year and month)
- information about fuel type and network pressure

Type	--
Model	--
Year	--
S.Number	--
Output	--
Oil Flow	--
Fuel	--
Category	--
Gas Pressure	--
Viscosity	--
El.Supply	--
El.Consump.	--
Fan Motor	--
Protection	--
Drwaing n°	--
P.I.N.	--

**SYMBOLS USED**

 **WARNING!** Failure to observe the warning may result in irreparable damage to the unit or damage to the environment

 **DANGER!** Failure to observe the warning may result in serious injuries or death.

 **WARNING!** Failure to observe the warning may result in electric shock with lethal consequences

## MICROPROCESSOR CONTROLLED SYSTEM

The control system is made of the Siemens LMV central unit that performs all the burner control functions and of the Siemens AZL local programming unit that interfaces the system with the user.

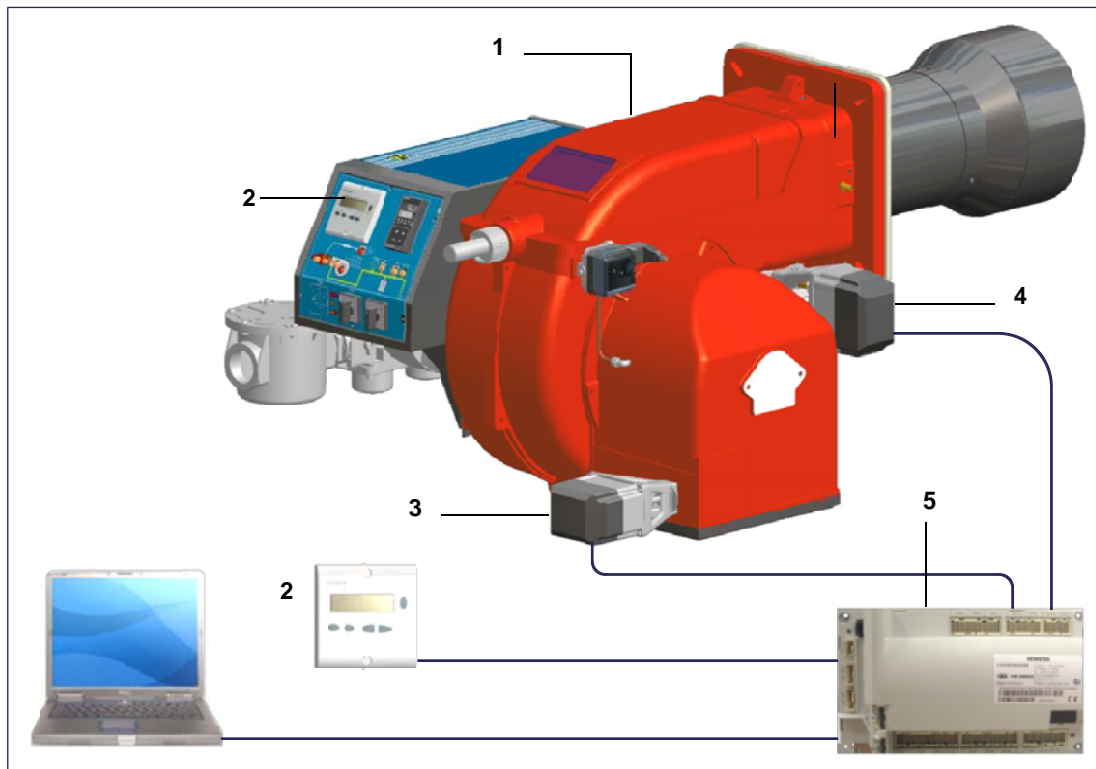

### Keys

- 1 Burner
- 2 AZL2..
- 3 Air actuator
- 4 Fuel actuator
- 5 LMV2..

### User interface

The AZL2x.. display/programming unit is shown below:

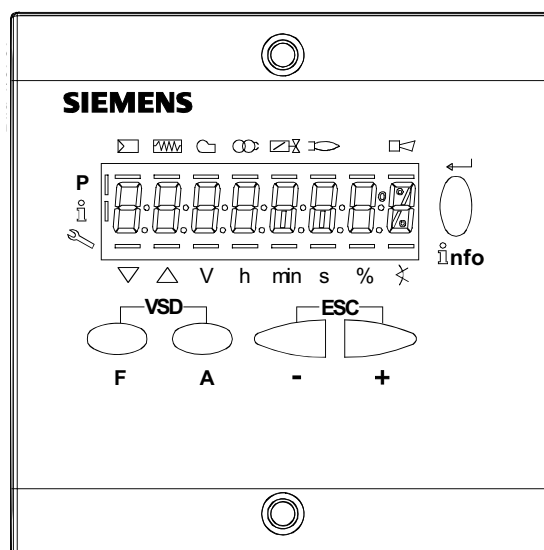

The keys functions are the following:



**Key F**

Used to adjust the “fuel” actuator position (**Fuel**):  
While pressing the **F** key, the “fuel” actuator position can be changed by means of the **+** and **-** keys.



**Key A**

Used to adjust the “air” actuator position (**Air**):  
While pressing the **A** key, the “air” actuator position can be changed by means of the **+** and **-** keys.

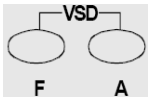

**Key F + A**

While pressing the two keys contemporarily, the **code** message will appear: by entering the proper password it is possible to access the **Service** mode.



**Info and Enter keys**

Used for **Info** and **Service** menus  
Used as **Enter** key in the setting modes  
Used as **Reset** key in the burner operation mode  
Used to enter a lower level menu



**-Key -**

Used to decrease a a value  
Used to enter Info and Service during the curve adjustments



**+Key +**

Used to increase a a value  
Used to enter Info and Service during the curve adjustments



**Keys (+ & -) = ESC**

By pressing + and - at the same time, the ESCAPE function is performed:  
to enter a lower level menu

The display will show these data:

- Lock+unlock codes
- Flame
- Open valves
- Ignition transformers energised
- Fan motor energised
- Oil pre-heater energised
- Plant heat request
- Parameter setting mode
- Info mode
- Service mode
- Closing actuator
- Opening actuator
- Unit measure

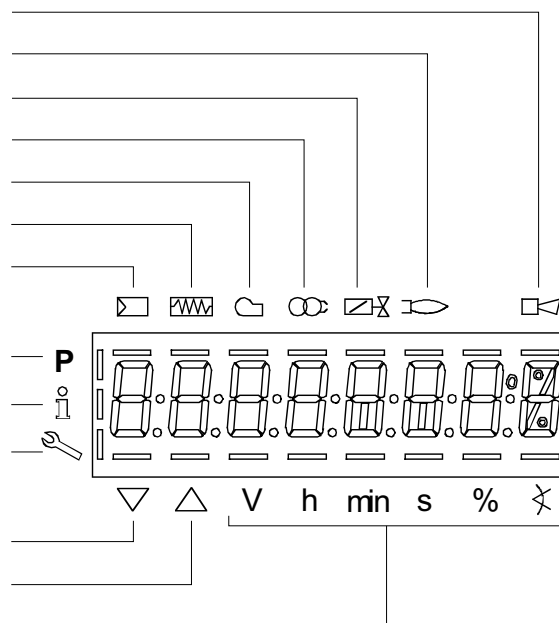

**Parameters level (heating engineer)**



---

## Setting menu

The setting menu is divided into different blocks:

<b>Bloc.</b>	<b>Descrizione</b>	<b>Description</b>	<b>Password</b>
000		Internal parameters	OEM / Service
100	Informazioni generali	General	OEM / Service / Info
200	Controllo bruciatore	Burner control	OEM / Service
300	Controllo bruciatore (solo <b>LMV26</b> )	Burner control ( <b>LMV26</b> only)	OEM / Service
400	Curve rapporto	Ratio curves	OEM / Service
500	Controllo rapporto	Ratio control	OEM / Service
600	Servocomandi	Actuators	OEM / Service
700	Storico errori	Error history	OEM / Service / Info
900	Dati di processo	Process data	OEM / Service / Info

The access to the various blocks is allowed by passwords. Passwords are divided into three levels:

- User level (info): no password needed
- Service level (Service)
- Manufacturer level (OEM)

**Block 000: Internal Parameter**

Param.	Descrizione	Description	Password
041	Password livello assistenza (ingegnere del calore)	Password heating engineer (4 characters)	OEM
042	Password livello OEM (costruttore del bruciatore)	Password OEM (5 characters)	OEM
050	Start backup/restore via AZL2x/PC	Start backup / restore via AZL2.../ PC software (set parameter to 1) Index 0: Create backup Index 1: Execute restore Error diagnostics via negative values (see error code 137)	SO
055	Identificazione bruciatore (backup dati)	Burner identification of AZL2... backup data set	SO
056		ASN extraction of AZL2... backup data set	SO
057	Versione software creata dal set dati backup	Software version when creating the AZL2... backup data set	Service / Info

**Block 100: General information**

Param.	Descrizione	Description	Password	LMV20 LMV27	LMV26	LMV37
102	Data produzione (in gg-mm-aa)	Identification date (yy-mm-dd)	Service / Info	x	x	x
103	Numero identificativ	Identification number	Service / Info	x	x	x
104	Set di parametri preimpostati: codice cliente	Preselected parameter set: customer code	Service / Info	x	x	x
105	Set di parametri preimpostati: versione	Preselected parameter set: version	Service / Info	x	x	x
107	Versione softwar	Software version	Service / Info	x	x	x
108	Variante software	Software variant	Service / Info	x	x	x
113	Identificativo bruciatore	Burner identification	Service / Info SO password for writing	x	x	x
121	Potenza manuale Valore "Undefined = automatico Impostare un valore inferiore a = in modo che il display mostri --- altrimenti, il controllore rimarrà sempre in stand-by e il display mostrerà la scritta OFF lampeggiante.	Manual output Undefined = automatic mode	Service / Info	x	x	x

125	Frequenza di rete 0 = 50 Hz 1 = 60 Hz	Mains frequency 0 = 50 Hz 1 = 60 Hz	Service / Info	x	x	x
126	Luminosità display	Display brightness	Service / Info	x	x	x
127	Tempo dopo il quale, se non viene premuto nessun tast il software esce dalla modalita programmazione (valore fabbrica = 60min - range impostazione: 10 - 120 min)	Timeout for menu operation (default value = 60min - range: 10 - 120 min)	OEM	x	x	x
130	Azzeramento Storico errori Impostare prima il parametro a 1 e poi a 2; se compare "0" = lo Storico è stato azzerato se compare "-1" = scaduto tempo sequ. 1_2	Delete display of error history To delete display : set to 1 then to 2; return value "0" = error history deleted return value "-1" = timeout of 1_2 sequence	OEM / Service	x	x	x
141	Attivazione comunicazione bus 0 = off 1 = Modbus 2 = riserva	Operating mode BACS 0 = off 1 = Modbus 2 = reserved	OEM / Service		x	x
142	Tempo d'arresto in caso di guasto di comunicazione	Setback time in the event of communication breakdown	OEM / Service		x	x
143	Riserva	Reserved	Service / Info		x	x
144	Riserva	Reserved	OEM / Service		x	x
145	Indirizzo dispositivo per Modbus	Device address for Modbus	OEM / Service		x	x
146	Velocità di trasmissione per Modbus	Baud rate for Modbus	OEM / Service		x	x
147	Parità per Modbus	Parity for Modbus	OEM / Service		x	x
148	on una interruzione della comunicazione bus: 0 ... 19.9 = bruciatore spento 20 ... 100 = 20 ... 100% potenza Per il funzionamento multistadio: 0 = bruciatore OFF, P1, P2, P3 non valido = nessun standard di prestazione della LMV.	Performance standard at interruption of communication with building automation For modulation operation the setting range is as follows: 0...19.9 = burner off 20...100 = 20...100% burner rating For multistage operation apply to setting range: 0 = burner OFF, P1, P2, P3 Invalid = no performance standards of the building auto-mation	OEM / Service		x	x
161	Numero di avarie	Number of faults	Service / Info	x	x	x
162	Ore di esercizio (azzerabile da Service)	Operating hours (resettable by Service)	Service / Info	x	x	x
163	Ore di esercizio (con dispositivo sotto tensione)	Operating hours (when unit is live)	Service / Info	x	x	x
164	Numero di partenze (azzerabile da Service)	Number of startups (resettable by Service)	Service / Info	x	x	x
165	Numero di partenze	Number of startups	Service / Info	x	x	x

166	Numero totale di partenze (non azzerabile)	Total number of startups	Service / Info	x	x	x
167	Volume combustibile (azzerabile da OEM)	Fuel volume (resettable by OEM)	Service / Info	x	x	x
172	Fuel 1(secondo combustibile)Ore di esercizio (azzerabile da Service)	Fuel 1: Operation hours resettable	Service / Info		x	
174	Fuel 1 (secondo combustibile) Numero di partenze (azzerabile da Service)	Fuel 1: Number of startups resettable	Service / Info		x	
175	Fuel 1 (secondo combustibile) Numero di partenze	Fuel 1: Number of startups	Service / Info		x	
177	Fuel 1 (secondo combustibile) Volume combustibile (azzerabile da OEM)	Fuel 1: Fuel volume resettable (m <sup>3</sup> , l, ft <sup>3</sup> , gal)	Service / Info		x	

**Block 200: Burner control**

Param.	Descrizione	Description	Password	LMV20 LMV27	LMV26	LMV37
201	<p>Modalità funzionamento bruciatore ( rampa combustibile, modulante / multistadio, servo-comandi, ecc.)</p> <p>___ = non definito (cancellazione curve)</p> <p><b>1</b> = accensione diretta a gas (G mod)</p> <p><b>2</b> = accensione tramite pilota gas con attacco tra le due elettrovalvole EV1/EV2 del gas (Gp1 mod)</p> <p><b>3</b> = accensione tramite pilota gas con attacco a monte dell'elettrovalvola EV1 del gas (Gp2 mod)</p> <p><b>4</b> = accensione a gasolio - modulante (Lo mod)</p> <p><b>5</b> = accensione a gasolio - bistadio (Lo 2 stage)</p> <p><b>6</b> = accensione a gasolio - tristadio (Lo 3 stage)</p> <p><b>7</b> = accensione diretta a gas - regolazione pneumatica (G mod pneu)</p> <p><b>8</b> = accensione tramite pilota gas con attacco tra le due elettrovalvole EV1/EV2 del gas - regolazione pneumatica (Gp1 mod pneu)</p> <p><b>9</b> = accensione tramite pilota gas con attacco a monte dell'elettrovalvola EV1 del gas - regolazione pneumatica (Gp2 mod pneu)</p>	<p>Burner operating mode (fuel train, modulating / multistage, actuators, etc..)</p> <p>___ = undefined (delete curves)</p> <p><b>1</b> = gas direct ignition (G mod)</p> <p><b>2</b> = ignition by gas pilot connected between the two gas solenoid valves EV1/EV2 (Gp1 mod)</p> <p><b>3</b> = ignition by gas pilot connected upstream the gas EV1 (Gp2 mod)</p> <p><b>4</b> = light oil ignition - modulating (Lo mod)</p> <p><b>5</b> = light oil ignition - double stage (Lo 2 stage)</p> <p><b>6</b> = light oil ignition - three stage (Lo 3 stage)</p> <p><b>7</b> = gas direct ignition - pneumatic regulation (G mod pneu)</p> <p><b>8</b> = ignition by gas pilot connected between the two gas solenoid valves EV1/EV2 - pneumatic regulation (Gp1 mod pneu)</p> <p><b>9</b> = ignition by gas pilot connected upstream the gas EV1 - pneumatic regulation (Gp2 mod pneu)</p>	OEM / Service	x	x	x
	<p><b>10</b> = olio modulante con accensione tramite pilota (LOGp mod)</p> <p><b>11</b> = olio 2 stadi con accensione tramite pilota (LOGp 2-stage)</p> <p><b>12</b> = olio modulante con 2 valvole combustibile (LOmod 2 valvole)</p> <p><b>13</b> = olio modulante con 2 valvole combustibile e con accensione tramite pilota (LOGp 2 valvole)</p> <p><b>14</b> = gas modulante pneumatico senza servomotori (Gmod pneu)</p>	<p><b>10</b> = LoGp mod</p> <p><b>11</b> = LoGp 2-stage</p> <p><b>12</b> = Lo mod 2 fuel valves</p> <p><b>13</b> = LoGp mod 2 fuel valves</p> <p><b>14</b> = G mod pneu without actuator</p>				

	<p><b>15</b> = gas rampa Gp1 modulante pneumatico senza servomotori (Gp1 mod pneu)</p> <p><b>16</b> = gas rampa Gp2 modulante pneumatico senza servomotori (Gp2 mod pneu)</p> <p><b>17</b> = olio LO 2 stadi senza servomotori</p> <p><b>18</b> = olio LO 3 stadi senza servomotori</p> <p><b>19</b> = gas Gmod con solo servomotore gas</p> <p><b>20</b> = gas Gp1 mod con solo servomotore gas</p> <p><b>21</b> = gas Gp2 mod con solo servomotore gas</p> <p><b>22</b> = olio LO mod con solo servomotore olio</p>	<p><b>15</b> = Gp1 mod pneu without actuator</p> <p><b>16</b> = Gp2 mod pneu without actuator</p> <p><b>17</b> = Lo 2-stage without actuator</p> <p><b>18</b> = Lo 3-stage without actuator</p> <p><b>19</b> = G mod gas actuator only</p> <p><b>20</b> = Gp1 mod gas actuator only</p> <p><b>21</b> = Gp2 mod gas actuator only</p> <p><b>22</b> = Lo mod oil actuator only</p>				
208	<p>Stop programma</p> <p><b>0</b> = non attivo</p> <p><b>1</b> = posizione preventilazione (Ph24 - fase 24 del programma)</p> <p><b>2</b> = posizione accensione (Ph36 - fase 36 del programma)</p> <p><b>3</b> = intervallo di tempo 1 (Ph44 - fase 44 del programma)</p> <p><b>4</b> = intervallo di tempo 2 (Ph52 - fase 52 del programma)</p>	<p>Program stop</p> <p><b>0</b> = deactivated</p> <p><b>1</b> = pre-purge position (Ph24 - program phase 24)</p> <p><b>2</b> = ignition position (Ph36 - program phase 36)</p> <p><b>3</b> = interval 1 (Ph44 - program phase 44)</p> <p><b>4</b> = interval 2 (Ph52 - program phase 52)</p>	OEM / Service	x	x	x
210	<p>Allarme impedimento avviamento</p> <p><b>0</b> = non attivo</p> <p><b>1</b> = attivo</p>	<p>Alarm in the event of start prevention</p> <p><b>0</b> = deactivated</p> <p><b>1</b> = activated</p>	OEM / Service	x	x	x
211	<p>Tempo aumento giri ventilatore (valore fabbrica = 2s - range impostazione: 2 - 60 s)</p>	<p>Fan ramp up time (default value = 2s - range: 2 - 60 s)</p>	OEM / Service	x	x	x
212	<p>Tempo massimo raggiungimento bassa fiamma (valore fabbrica = 45 s - range impostazione: 0.2 s - 10 min)</p> <p>Stabilisce il massimo intervallo di tempo durante il quale il bruciatore raggiunge la minima potenza e poi si spegne</p>	<p>Maximum time down to low-fire (default value = 45 s - range: 0.2 s - 10 min)</p> <p>It states the maximum time interval during which the burner drives to the low output and then turns off</p>	OEM / Service		x	
213	<p>Tempo minimo raggiungimento posizione di stand by (valore fabbrica = 2 s - range impostazione: 2 - 60 s)</p>	<p>Min. time home run (default value = 2 s - range: 2 - 60 s)</p>	OEM	x	x	x
214	<p>Tempo massimo inizio partenza</p>	<p>Max. time start release</p>	OEM	x	x	x
215	<p>Limite ripetizioni catena di sicurezza (valore fabbrica = 16 - range impostazione: 1 - 16)</p>	<p>Repetition limit safety loop (default value = 16 - range: 1 - 16)</p>	OEM / Service	x	x	x
217	<p>Tempo massimo per rilevazione segnale (valore fabbrica = 30s - range impostazione: 5s - 10 min)</p>	<p>Max. time to detector signal (default value = 30s - range: 5s - 10 min)</p>	OEM	x	x	x

221	Gas: sonda rilevazione fiamma attivo (valore fabbrica = 1)	Gas: active detector flame evaluation (default value = 1) <b>0</b> = QRB../QRC.. <b>1</b> = ION / QRA..	OEM / Service	x	x	x
222	Gas: Preventilazione (valore fabbrica = 1) <b>1</b> = attivo <b>0</b> = non attivo ATTENZIONE : In ambito civile la norma EN676 rende obbligatoria la preventilazione. In ambito industriale, vedere i casi in cui la norma EN746-2 prevede la possibilità di non fare la preventilazione. In questi ultimi casi il bruciatore deve essere costruito obbligatoriamente con controllo di tenuta e valvole gas in classe A	Gas: Pre-purging (default value = 1) <b>1</b> = active <b>0</b> = deactivated WARNING: in the civil field, the prepurge is mandatory according to the standard EN676. In the industrial fiels, check if the pre purge can be avoided according to the stanrds EN746-2 If the prepurge is not performed, the burner must be equipped with two valves and the proving system.	OEM / Service	x	x	x
223	Limite ripetizioni pressostato gas di minima pressione (valore fabbrica = 16 - range impostazione:1 - 16)	Repetition limit pressure switch-min-gas (default value = 16 - range:1 - 16)	OEM / Service	x	x	x
225	Gas: tempo di preventilazione (valore fabbrica = 20s - range impostazione:20s - 60min)	Gas: Prepurge time (default value = 20s - range:20s - 60min)	OEM / Service	x	x	x
226	Gas: tempo di preaccensione (valore fabbrica = 2s - range impostazione:0.2s - 60min)	Gas: Preignition time (default value = 2s - range: 0.2s - 60min)	OEM / Service	x	x	x
227	Gas: tempo di sicurezza 1 (TSA1) (valore fabbrica = 3s - range impostazione:0.2 - 10s)	Gas: Safety time 1 (TSA1) (default value = 3s - range: 0.2 - 10s)	OEM	x	x	x
229	Gas: tempo di risposta a cadute di pressione entro TSA1 e TSA2 (valore fabbrica = 1.8s - range impostazione:0.2s - 9.8s)	Gas: time to respond to pressure faults in TSA1 e TSA2 (default value = 1.8s - range: 0.2s - 9.8s)	OEM	x	x	x
230	Gas: Intervallo 1 (valore fabbrica = 2s - range impostazione:0.2s - 60min)	Gas: Interval 1 (default value = 2s - range: 0.2s - 60min)	OEM / Service	x	x	x
231	Gas: tempo di sicurezza 2 (TSA2) (valore fabbrica = 3s - range impostazione:0.2 - 10s)	Gas: Safety time 2 (TSA2) (default value = 3s - range:0.2 - 10s)	OEM	x	x	x
232	Gas: Intervallo 2 (valore fabbrica = 2s - range impostazione:0.2s - 60min)	Gas: Interval 2 (default value = 2s - range:0.2s - 60min)	OEM / Service	x	x	
233	Gas: Tempo postcombustione (valore fabbrica = 8s - range impostazione:0.2s - 60s)	Gas: postcombustion time (default value = 8s - range:0.2s - 60s)	OEM / Service	x	x	x
234	Gas: Tempo postventilazione (valore fabbrica = 0.2s - range impostazione:0.2s - 180min)	Gas: Postpurge time (default value = 0.2s - range:0.2s - 180min)	OEM / Service	x	x	x

236	Gas: Pressostato gas di minima (default = 1) 0 = inattivo 1 = pressostato gas di minima (a monte valvola V1) 2 = controllo perditavalvole via pressostato (montato tra le valvole V1 e V2)	Gas: Pressure switch-min input 0 = inactive 1 = pressure switch-min (upstream of fuel valve 1 (V1)) 2 = valve proving via pressure switch-min (between fuel valves 1 (V1) and 2 (V2))	OEM / Service	x	x	
237	Gas: Pressostato gas di massima / ingresso-POC 0 = inattivo 1= pressostato gas di massima 2= POC 3 = pressostato controllo perdite	Gas: Pressure switch-max / POC input 0 = inactive 1 = pressure switch-max 2 = POC 3 = pressure switch valve proving			x	x
239	Gas: Forzatura al funzionamento intermittente 0 = disattivato 1 = attivato Attenzione : di default questo parametro è attivo = (1); esso è modificabile solo su LMV37. Dal punto di vista della sicurezza, il funzionamento continuo è valido esclusivamente per bruciatori di gas con elettrodo di rilevazione.	Gas: Forced intermittent operation 0 = deactivated 1 = activated	OEM			x
240	Limite ripetizioni perdita di fiamma (valore fabbrica = 2 - range impostazione:1 - 2)	Repetition limit loss of flame (default value= 2 - range:1 - 2)	OEM	x	x	x
241	Gas: esecuzione controllo tenuta (valore fabbrica = 2) <b>0</b> = no controllo tenuta <b>1</b> = controllo tenuta in avviamento <b>2</b> = controllo tenuta in arresto <b>3</b> = controllo tenuta in arresto e in avviamento	Gas: execution proving test (default value= 2) <b>0</b> = no proving test <b>1</b> = proving test on startup <b>2</b> = proving test on shutdown <b>3</b> = proving test on shutdown and on startup	OEM / Service	x	x	x
242	Gas: tempo evacuazione controllo tenuta (valore fabbrica = 3s - range impostazione:0.2s - 10s)	Gas: proving test evacuation time (default value = 3s - range:0.2s - 10s)	OEM	x	x	x

243	Gas: tempo pressione atmosferica controllo tenuta (valore fabbrica = 10s - range impostazione:0.2s - 60s)	Gas: proving test time atmospheric pressure (default value = 10s - range:0.2s - 60s)	OEM	x	x	x
244	Gas: tempo riempimento controllo tenuta (valore fabbrica = 3s - range impostazione:0.2s - 10s)	Gas: proving test filling time (default value = 3s - range:0.2s - 10s)	OEM	x	x	x
245	Gas: tempo test pressione gas (valore fabbrica = 10s - range impostazione:0.2s - 60s)	Gas: proving test time gas pressure (default value = 10s - range:0.2s - 60s)	OEM	x	x	x
246	Gas: tempo attesa consenso pressostato di minima (valore fabbrica = 10s - range impostazione:0.2s - 60s) Se la pressione del gas è troppo bassa, in fase 22 non verrà eseguito l'avviamento: il sistema compie un numero impostabile di tentativi finché non si arriva al blocco. Il tempo di attesa tra un tentativo e il successivo viene raddoppiato ad ogni tentativo.	Gas: waiting time gas shortage (default value = 10s - range:0.2s - 60s) If the gas pressure is too low, in phase 22 the startup will not be performed: the system tries for a certain number of times the it locks out. The time interval between two attempts is doubled at each attempt.	OEM	x	x	x
248	Gas: Tempo di post-ventilazione 3 (abortito con regolatore di potenza (LR)-ON	Gas: Postpurge time 3 (abortion with load controller (LR)-ON	OEM / Service	x	x	x
261	Olio: sonda rilevazione fiamma attivo (valore fabbrica = 0) <b>0</b> = QRB../QRC.. <b>1</b> = ION / QRA..	Oil: active detector flame evaluation (default value = 0) <b>0</b> = QRB../QRC.. <b>1</b> = ION / QRA..	OEM / Service	x	x	x
262	Olio: preventilazione (valore fabbrica = 1) <b>1</b> = attivo <b>0</b> = non attivo In ambito civile la norma EN267 rende obbligatoria la preventilazione. In ambito industriale, vedere i casi in cui la norma EN746-2 prevede la possibilità di non fare la preventilazione.	Oil: prepurging (default value = 1) <b>0</b> = deactivated <b>1</b> = activated <b>0</b> = deactivated WARNING: in the civil field, the prepurge is mandatory according to the standard EN267. In the industrial fiels, check if the pre purge can be avoided according to the standard EN746-2	OEM / Service	x	x	x
265	Olio: tempo preventilazione (valore fabbrica = 15s - range impostazione:15s - 60min)	Oil: prepurging time (default value = 15s - range:15s - 60min)	OEM / Service	x	x	x
266	Olio: tempo preaccensione (valore fabbrica = 2s - range impostazione:0.2s - 60min)	Oil: preignition time (default value = 2s - range:0.2s - 60min)	OEM / Service	x	x	x
267	Olio: tempo di sicurezza 1 (TSA1) (valore fabbrica = 5s - range impostazione:0.2 - 15s)	Oil: safety time 1 (TSA1) (default value = 5s - range:0.2 - 15s)	OEM	x	x	x
269	Olio: tempo di risposta a cadute di pressione entro TSA1 e TSA2 (valore fabbrica = 1.8s - range impostazione:0.2s - 14.8s)	Oil: time to respond to pressure faults in TSA1 and TSA2 (default value = 1.8s - range:0.2s - 14.8s)	OEM	x	x	x

270	Olio: Intervallo 1 (valore fabbrica = 2s - range impostazione:0.2s - 60min)	Oil: Interval 1 (default value = 2s - range:0.2s - 60min)	OEM / Service	x	x	x
271	Olio: tempo di sicurezza 2 (TSA2) (valore fabbrica = 3s - range impostazione:0.2 - 10s)	Oil: safety time 2 (TSA2) (default value = 3s - range:0.2 - 10s)	OEM	x	x	x
272	Olio: Intervallo 2 (valore fabbrica = 2s - range impostazione:0.2s - 60min)	Oil: Interval 2 (default value = 2s - range:0.2s - 60min)	OEM / Service	x	x	x
273	Olio: Tempo postcombustione (valore fabbrica = 8s - range impostazione:0.2s - 60s)	Oil: Postcombustion time (default value = 8s - range:0.2s - 60s)	OEM / Service	x	x	x
274	Olio: Tempo postventilazione (valore fabbrica = 0.2s - range impostazione:0.2s - 180min)	Oil: Postpurging time (default value = 0.2s - range:0.2s - 180min)	OEM / Service	x	x	x
276	Olio : Pressostato olio di minima (default = 1) 0 = inattivo 1 = attivo dalla fase 38 2 = attivo dal tempo di sicurezza (TSA)	Oil. Pressure switch-min input 0 = inactive 1 = active from phase 38 2 = active from safety time (TSA)	OEM / Service	x	x	
277	Olio: Pressostato olio di massima / ingresso-POC 0 = inattivo 1= pressostato olio di massima 2= POC	Oil: Pressure switch-max/POC input 0 = inactive 1 = pressure switch-max 2 = POC			x	
279	Olio: Forzatura al funzionamento intermittente 0 = disattivato 1 = attivato Attenzione : di default questo parametro è attivo = (1); esso è modificabile solo su LMV37..	Oil: Forced intermittent operation 0 = deactivated 1 = activated	OEM		x	x
280	Limite ripetizioni perdita di fiamma (valore fabbrica = 2 - range impostazione:1 - 2)	Repetition limit value loss of flame (default value = 2 - range:1 - 2)	OEM	x	x	x
281	Olio: tempo iniezione olio (valore fabbr. = 1) <b>0</b> = preaccensione corta (Ph38 - fase programma 38) <b>1</b> = preaccensione lunga (con ventilatore) (Ph22 - fase programma 22)	Oil: time oil ignition (default value = 1) <b>0</b> = short preignition (Ph38-progr. phase 38) <b>1</b> = long preignition (with fan) (Ph22 - program phase 22)	OEM / Service	x	x	x
284	Olio: Tempo di post-ventilazione 3 (abortito con regolatore di potenza (LR)-ON	Oil: Postpurge time 3 (abortion with load controller (LR)-ON	OEM / Service	x	x	x

**Block 300: Burner control (only with LMV26)**

Param.	Descrizione	Description	Password	LMV20 LMV27	LMV26	LMV37
301	<p>Combustibile 1 : Modalità funzionamento bruciatore ( rampa combustibile, modulante / multistadio, servocomandi, ecc.)</p> <p>__ = non definito (cancellazione curve)</p> <p><b>1</b> = accensione diretta a gas (G mod)</p> <p><b>2</b> = accensione tramite pilota gas con attacco tra le due elettrovalvole EV1/EV2 del gas (Gp1 mod)</p> <p><b>3</b> = accensione tramite pilota gas con attacco a monte dell'elettrovalvola EV1 del gas (Gp2 mod)</p> <p><b>4</b> = accensione a gasolio - modulante (Lo mod)</p> <p><b>5</b> = accensione a gasolio - bistadio (Lo 2 stage)</p> <p><b>6</b> = accensione a gasolio - tristadio (Lo 3 stage)</p> <p><b>7</b> = accensione diretta a gas - regolazione pneumatica (G mod pneu)</p> <p><b>8</b> = accensione tramite pilota gas con attacco tra le due elettrovalvole EV1/EV2 del gas - regolazione pneumatica (Gp1 mod pneu)</p> <p><b>9</b> = accensione tramite pilota gas con attacco a monte dell'elettrovalvola EV1 del gas - regolazione pneumatica (Gp2 mod pneu)</p> <p><b>10</b> = olio modulante con accensione tramite pilota (LOGp mod)</p>	<p>Fuel 1 : Burner operating mode (fuel train, modulating / multistage, actuators, etc..)</p> <p>__ = undefined (delete curves)</p> <p><b>1</b> = gas direct ignition (G mod)</p> <p><b>2</b> = ignition by gas pilot connected between the two gas solenoid valves EV1/EV2 (Gp1 mod)</p> <p><b>3</b> = ignition by gas pilot connected upstream the gas EV1 (Gp2 mod)</p> <p><b>4</b> = light oil ignition - modulating (Lo mod)</p> <p><b>5</b> = light oil ignition - double stage (Lo 2 stage)</p> <p><b>6</b> = light oil ignition - three stage (Lo 3 stage)</p> <p><b>7</b> = gas direct ignition - pneumatic regulation (G mod pneu)</p> <p><b>8</b> = ignition by gas pilot connected between the two gas solenoid valves EV1/EV2 - pneumatic regulation (Gp1 mod pneu)</p> <p><b>9</b> = ignition by gas pilot connected upstream the gas EV1 - pneumatic regulation (Gp2 mod pneu)</p> <p><b>10</b> = LoGp mod</p>	OEM / Service		x	

	<p><b>11</b> = olio 2 stadi con accensione tramite pilota (LOGp 2-stage)</p> <p><b>12</b> = olio modulante con 2 valvole combustibile (LOmod 2 valvole)</p> <p><b>13</b> = olio modulante con 2 valvole combustibile e con accensione tramite pilota (LOGp 2 valvole)</p> <p><b>14</b> = gas modulante pneumatico senza servomotori (Gmod pneu)</p> <p><b>15</b> = gas rampa Gp1 modulante pneumatico senza servomotori (Gp1 mod pneu)</p> <p><b>16</b> = gas rampa Gp2 modulante pneumatico senza servomotori (Gp2 mod pneu)</p>	<p><b>11</b> = LoGp 2-stage</p> <p><b>12</b> = Lo mod 2 fuel valves</p> <p><b>13</b> = LoGp mod 2 fuel valves</p> <p><b>14</b> = G mod pneu without actuator</p> <p><b>15</b> = Gp1 mod pneu without actuator</p> <p><b>16</b> = Gp2 mod pneu without actuator</p>				
	<p><b>17</b> = olio LO 2 stadi senza servomotori</p> <p><b>18</b> = olio LO 3 stadi senza servomotori</p> <p><b>19</b> = gas Gmod con solo servomotore gas</p> <p><b>20</b> = gas Gp1 mod con solo servomotore gas</p> <p><b>21</b> = gas Gp2 mod con solo servomotore gas</p> <p><b>22</b> = olio LO mod con solo servomotore olio</p>	<p><b>17</b> = Lo 2-stage without actuator</p> <p><b>18</b> = Lo 3-stage without actuator</p> <p><b>19</b> = G mod gas actuator only</p> <p><b>20</b> = Gp1 mod gas actuator only</p> <p><b>21</b> = Gp2 mod gas actuator only</p> <p><b>22</b> = Lo mod oil actuator only</p>			x	
321	<p>Combustibile 1 - Gas: sonda rilevazione fiamma attivo (valore fabbrica = 1) -</p> <p><b>0</b> = QRB../QRC..</p> <p><b>1</b> = ION / QRA..</p>	<p>Fuel 1 - Gas: active detector flame evaluation (default value = 1)</p> <p><b>0</b> = QRB../QRC..</p> <p><b>1</b> = ION / QRA..</p>	OEM / Service		x	
322	<p>Combustibile 1 - Gas: Preventilazione (valore fabbrica = 1)</p> <p><b>1</b> = attivo</p> <p><b>0</b> = non attivo</p> <p>ATTENZIONE : In ambito civile la norma EN676 rende obbligatoria la preventilazione. In ambito industriale, vedere i casi in cui la norma EN746-2 prevede la possibilità di non fare la preventilazione.</p> <p>In questi ultimi casi il bruciatore deve essere costruito obbligatoriamente con controllo di tenuta e valvole gas in classe A.</p>	<p>Fuel 1 - Gas: Pre-purging (default value = 1)</p> <p><b>1</b> = active</p> <p><b>0</b> = deactivated</p> <p>WARNING: in the civil field, the prepurge is mandatory according to the standard EN676. In the industrial fiels, check if the pre purge can be avoided according to the stanrds EN746-2</p> <p>If the prepurge is not performed, the burner must be equipped with two valves and the proving system.</p>	OEM / Service		x	
323	<p>Limite ripetizioni pressostato gas di minima pressione (valore fabbrica = 16 - range impostazione:1 - 16)</p>	<p>Repetition limit pressure switch-min-gas (default value = 16 - range:1 - 16)</p>	OEM / Service		x	
325	<p>Combustibile 1 - Gas: tempo di preventilazione (valore fabbrica = 20s - range impostazione:20s - 60min)</p>	<p>Fuel 1 - Gas: Prepurge time (default value = 20s - range:20s - 60min)</p>	OEM / Service		x	

326	Combustibile 1 - Gas: tempo di preaccensione (valore fabbrica = 2s - range impostazione:0.2s - 60min)	Fuel 1 - Gas: Preignition time (default value = 2s - range: 0.2s - 60min)	OEM / Service		x	
327	Combustibile 1 - Gas: tempo di sicurezza 1 (TSA1) (valore fabbrica = 3s - range impostazione:0.2 - 10s)	Fuel 1 - Gas: Safety time 1 (TSA1) (default value = 3s - range: 0.2 - 10s)	OEM		x	
329	Combustibile 1 - Gas: tempo di risposta a cadute di pressione entro TSA1 e TSA2 (valore fabbrica = 1.8s - range impostazione:0.2s - 9.8s)	Fuel 1 - Gas: time to respond to pressure faults in TSA1 e TSA2 (default value = 1.8s - range: 0.2s - 9.8s)	OEM		x	
330	Combustibile 1 - Gas: Intervallo 1 (valore fabbrica = 2s - range impostazione:0.2s - 60min)	Fuel 1 - Gas: Interval 1 (default value = 2s - range: 0.2s - 60min)	OEM / Service		x	
331	Combustibile 1 - Gas: tempo di sicurezza 2 (TSA2) (valore fabbrica = 3s - range impostazione:0.2 - 10s)	Fuel 1 - Gas: Safety time 2 (TSA2) (default value = 3s - range:0.2 - 10s)	OEM		x	
332	Combustibile 1 - Gas: Intervallo 2 (valore fabbrica = 2s - range impostazione:0.2s - 60min)	Fuel 1 - Gas: Interval 2 (default value = 2s - range:0.2s - 60min)	OEM / Service		x	
333	Combustibile 1 - Gas: Tempo postcombustione (valore fabbrica = 8s - range impostazione:0.2s - 60s)	Fuel 1 - Gas: postcombustion time (default value = 8s - range:0.2s - 60s)	OEM / Service		x	
334	Combustibile 1 - Gas: Tempo postventilazione (valore fabbrica = 0.2s - range impostazione:0.2s - 180min)	Fuel 1 - Gas: Postpurge time (default value = 0.2s - range:0.2s - 180min)	OEM / Service		x	
336	Combustibile 1 - Gas: Pressostato gas di minima (default = 1) 0 = inattivo 1 = pressostato gas di minima (a monte valvola V1) 2 = controllo perditavalvole via pressostato (montato tra le valvole V1 e V2)	Fuel 1 - Gas: Pressure switch-min input 0 = inattivo 1 = pressure switch-min (upstream of fuel valve 1 (V1)) 2 = valve proving via pressure switch-min (between fuel valves 1 (V1) and 2 (V2))	OEM / Service		x	
337	Combustibile 1 - Gas: Pressostato gas di massima / ingressoPOC 0 = inattivo 1= pressostato gas di massima 2= POC 3 = pressostato controllo perdite	Fuel 1 - Gas: Pressure switch-max / POC input 0 = inattivo 1 = pressure switch-max 2 = POC 3 = pressure switch valve proving			x	

340	Limite ripetizioni perdita di fiamma (valore fabbrica = 2 - range impostazione:1 - 2)	Repetition limit loss of flame (default value= 2 - range:1 - 2)	OEM		x	
341	Combustibile 1 - Gas: esecuzione controllo tenuta (valore fabbrica = 2) <b>0</b> = no controllo tenuta <b>1</b> = controllo tenuta in avviamento <b>2</b> = controllo tenuta in arresto <b>3</b> = controllo tenuta in arresto e in avviamento	Fuel 1 - Gas: execution proving test (default value= 2) <b>0</b> = no proving test <b>1</b> = proving test on startup <b>2</b> = proving test on shutdown <b>3</b> = proving test on shutdown and on startup	OEM / Service		x	
342	Combustibile 1 - Gas: tempo evacuazione controllo tenuta (valore fabbrica = 3s - range impostazione:0.2s - 10s)	Fuel 1 - Gas: proving test evacuation time (default value = 3s - range:0.2s - 10s)	OEM		x	
343	Combustibile 1 - Gas: tempo pressione atmosferica controllo tenuta (valore fabbrica = 10s - range impostazione:0.2s - 60s)	Fuel 1 - Gas: proving test time atmospheric pressure (default value = 10s - range:0.2s - 60s)	OEM		x	
344	Combustibile 1 - Gas: tempo riempimento controllo tenuta (valore fabbrica = 3s - range impostazione:0.2s - 10s)	Fuel 1 - Gas: proving test filling time (default value = 3s - range:0.2s - 10s)	OEM		x	
345	Combustibile 1 - Gas: tempo test pressione gas (valore fabbrica = 10s - range impostazione:0.2s - 60s)	Fuel 1 - Gas: proving test time gas pressure (default value = 10s - range:0.2s - 60s)	OEM		x	
346	Combustibile 1 - Gas: tempo attesa consenso pressostato di minima (valore fabbrica = 10s - range impostazione:0.2s - 60s) Se la pressione del gas è troppo bassa, in fase 22 non verrà eseguito l'avviamento: il sistema compie un numero impostabile di tentativi finché non si arriva al blocco. Il tempo di attesa tra un tentativo e il successivo viene raddoppiato ad ogni tentativo.	Fuel 1 - Gas: waiting time gas shortage (default value = 10s - range:0.2s - 60s) If the gas pressure is too low, in phase 22 the startup will not be performed: the system tries for a certain number of times the it locks out. The time interval between two attempts is doubled at each attempt.	OEM		x	
348	Combustibile 1 - Gas: Tempo di post-ventilazione 3 (abortito con regolatore di potenza (LR)-ON	Fuel 1 - Gas: Postpurge time 3 (abortion with load controller (LR)-ON	OEM / Service		x	
361	Combustibile 1 - Olio: sonda rilevazione fiamma attivo (valore fabbrica = 0) <b>0</b> = QRB../QRC.. <b>1</b> = ION / QRA..	Fuel 1 - Oil: active detector flame evaluation (default value = 0) <b>0</b> = QRB../QRC.. <b>1</b> = ION / QRA..	OEM / Service		x	

362	Combustibile 1 - Olio: preventilazione (valore fabbrica = 1) 1 = attivo 0 = non attivo In ambito civile la norma EN267 rende obbligatoria la preventilazione. In ambito industriale, vedere i casi in cui la norma EN746-2 prevede la possibilità di non fare la preventilazione.	Fuel 1 - Oil: prepurging (default value = 1) 0 = deactivated 1 = activated 0 = deactivated WARNING: in the civil field, the prepurge is mandatory according to the standard EN267. In the industrial fiels, check if the pre purge can be avoided according to the standard EN746-2	OEM / Service		x	
365	Combustibile 1 - Olio: tempo preventilazione (valore fabbrica = 15s - range impostazione:15s - 60min)	Fuel 1 - Oil: prepurging time (default value = 15s - range:15s - 60min)	OEM / Service		x	
366	Combustibile 1 - Olio: tempo preaccensione (valore fabbrica = 2s - range impostazione:0.2s - 60min)	Fuel 1 - Oil: preignition time (default value = 2s - range:0.2s - 60min)	OEM / Service		x	
367	Combustibile 1 - Olio: tempo di sicurezza 1 (TSA1) (valore fabbrica = 5s - range impostazione:0.2 - 15s)	Fuel 1 - Oil: safety time 1 (TSA1) (default value = 5s - range:0.2 - 15s)	OEM		x	
369	Combustibile 1 - Olio: tempo di risposta a cadute di pressione entro TSA1 e TSA2 (valore fabbrica = 1.8s - range impostazione:0.2s - 14.8s)	Fuel 1 - Oil: time to respond to pressure faults in TSA1 and TSA2 (default value = 1.8s - range:0.2s - 14.8s)	OEM		x	
370	Combustibile 1 - Olio: Intervallo 1 (valore fabbrica = 2s - range impostazione:0.2s - 60min)	Fuel 1 - Oil: Interval 1 (default value = 2s - range:0.2s - 60min)	OEM / Service		x	
371	Combustibile 1 - Olio: tempo di sicurezza 2 (TSA2) (valore fabbrica = 3s - range impostazione:0.2 - 10s)	Fuel 1 - Oil: safety time 2 (TSA2) (default value = 3s - range:0.2 - 10s)	OEM		x	
372	Combustibile 1 - Olio: Intervallo 2 (valore fabbrica = 2s - range impostazione:0.2s - 60min)	Fuel 1 - Oil: Interval 2 (default value = 2s - range:0.2s - 60min)	OEM / Service		x	
373	Combustibile 1 - Olio: Tempo postcombustione (valore fabbrica = 8s - range impostazione:0.2s - 60s)	Fuel 1 - Oil: Postcombustion time (default value = 8s - range:0.2s - 60s)	OEM / Service		x	
374	Combustibile 1 - Olio: Tempo postventilazione (valore fabbrica = 0.2s - range impostazione:0.2s - 180min)	Fuel 1 - Oil: Postpurging time (default value = 0.2s - range:0.2s - 180min)	OEM / Service		x	
377	Combustibile 1 - Olio: Pressostato olio di massima / ingresso POC 0 = inattivo 1= pressostato olio di massima 2= POC	Fuel 1 - Oil: Pressure switch-max/POC input 0 = inactive 1 = pressure switch-max 2 = POC			x	

380	Limite ripetizioni perdita di fiamma (valore fabbrica = 2 - range impostazione:1 - 2)	Repetition limit value loss of flame (default value = 2 - range:1 - 2)	OEM		x	
381	Combustibile 1 - Olio: tempo iniezione olio (valore fabbr. = 1) <b>0</b> = preaccensione corta (Ph38 - fase programma 38) <b>1</b> = preaccensione lunga (con ventilatore) (Ph22 - fase programma 22)	Fuel 1 - Oil: time oil ignition (default value = 1) <b>0</b> = short preignition (Ph38-progr. phase 38) <b>1</b> = long preignition (with fan) (Ph22 - program phase 22)	OEM / Service		x	
384	Combustibile 1 - Olio: Tempo di post-ventilazione 3 (abortito con regolatore di potenza (LR)-ON)	Fuel 1 - Oil: Postpurge time 3 (abortion with load controller (LR)-ON)	OEM / Service		x	

**Block 400: Setting air/fuel ratio curves**

Param.	Descrizione	Description	Password	LMV20 LMV27	LMV26	LMV37
401	Curve controllo servocomando combustibile (F): si accede alla lista dei punti da impostare (da P0 a P9) - consultare paragrafo "Impostazione curve"	Ratio control curve fuel actuator (F): it accesses to the parameter list of the points to be set (P0 to P9) - see paragraph "Setting the curves"	OEM / Service	x	x	x
402	Curve controllo servocomando aria (A): si accede alla lista dei punti da impostare (da P0 a P9) - consultare paragrafo "Impostazione curve"	Ratio control curve air actuator (A): it accesses to the parameter list of the points to be set (P0 to P9) - see paragraph "Setting the curves"	OEM / Service	x	x	x
403	Curve controllo inverter (F + A): si accede alla lista dei punti da impostare (da P0 a P9) - consultare paragrafo "Impostazione curve"	Ratio control curves VSD (curve setting only)	SO		x	x
404	Combustibile 1 - Curve controllo servocomando combustibile 1 (F): si accede alla lista dei punti da impostare (da P0 a P9) - consultare paragrafo "Impostazione curve"	Fuel 1: Ratio control curves fuel actuator (curve setting only)	SO		x	
405	Combustibile 1 - Curve controllo servocomando aria (A): si accede alla lista dei punti da impostare (da P0 a P9) - consultare paragrafo "Impostazione curve"	Fuel 1: Ratio control curves air actuator (curve setting only)	SO		x	
406	Combustibile 1 - Curve controllo inverter (F + A): si accede alla lista dei punti da impostare (da P0 a P9) - consultare paragrafo "Impostazione curve"	Fuel 1: Ratio control curves VSD (curve setting only)	SO		x	

**Block 500: Air/fuel ratio control**

Param.	Descrizione	Description	Password	LMV20	LMV26	LMV37
				LMV27		
501	Posizione <b>servocomando combustibile</b> in assenza di fiamma (no-flame) <b>Indice 0</b> = posizione di sosta = 0° <b>Indice 1</b> = posizione preventilazione = 0° <b>Indice 2</b> = posizione postventilazione = 15°	No-flame position fuel actuator  <b>Index 0</b> = no-load position = 0° <b>Index 1</b> = prepurge position = 0° <b>Index 2</b> = postpurge position = 15°	OEM / Service	x	x	x
502	Posizione <b>servocomando aria</b> in assenza di fiamma (no-flame) <b>Indice 0</b> = posizione di sosta = 0° <b>Indice 1</b> = posizione preventilazione = 90° <b>Indice 2</b> = posizione postventilazione = 45°	No-flame position air actuator  <b>Index 0</b> = no-load position = 0° <b>Index 1</b> = prepurge position = 90° <b>Index 2</b> = postpurge position = 45°	OEM / Service	x	x	x
503	% <b>giri motore con inverter</b> 0% = ventilatore fermo, 100% = ventilatore al massimo della velocità <b>Indice 0</b> = posizione di sosta = 0% <b>Indice 1</b> = posizione preventilazione = 100% <b>Indice 2</b> = posizione postventilazione = 50%	No-flame speeds VSD Index 0 = no-load speed = 0% Index 1 = prepurge speed = 100% Index 2 = postpurge speed = 50%	OEM / Service		x	x
504	Combustibile 1 - Posizione <b>servocomando combustibile</b> in assenza di fiamma (no-flame) <b>Indice 0</b> = posizione di sosta = 0° <b>Indice 1</b> = posizione preventilazione = 0° <b>Indice 2</b> = posizione postventilazione = 15°	Fuel 1 No-flame position fuel actuator  <b>Index 0</b> = no-load position = 0° <b>Index 1</b> = prepurge position = 0° <b>Index 2</b> = postpurge position = 15°	OEM / Service		x	
505	Combustibile 1 - Posizione <b>servocomando aria</b> in assenza di fiamma (no-flame) <b>Indice 0</b> = posizione di sosta = 0° <b>Indice 1</b> = posizione preventilazione = 90° <b>Indice 2</b> = posizione postventilazione = 45°	Fuel 1 No-flame position air actuator  <b>Index 0</b> = no-load position = 0° <b>Index 1</b> = prepurge position = 90° <b>Index 2</b> = postpurge position = 45°	OEM / Service		x	
506	Combustibile 1 - % <b>giri motore con inverter</b> 0% = ventilatore fermo, 100% = ventilatore al massimo della velocità <b>Indice 0</b> = posizione di sosta = 0% <b>Indice 1</b> = posizione preventilazione = 100% <b>Indice 2</b> = posizione postventilazione = 50%	Fuel 1 No-flame speeds VSD Index 0 = no-load speed = 0% Index 1 = prepurge speed = 100% Index 2 = postpurge speed = 50%	OEM / Service		x	
522	Tempo rampa di salita inverter	Ramp up	OEM / Service		x	x
523	Tempo rampa di discesa inverter	Ramp down	OEM / Service		x	x

542	Activation of VSD / PWM fan (PWM = Pulse-Width Modulation) 0=deactivated 1=activated	Activation of VSD / PWM fan (PWM = Pulse-Width Modulation)	OEM / Service		x	x
-----	---	---	---------------	--	---	---

544			Parameter 544				OEM / Service	x	x	x
	Actuator	Actuating speed parameter 613	Modulation <b>32s</b>	Modulation <b>48s</b>	Modulation <b>64s</b>	Modulation <b>80s</b>				
			Max. delta between the curve points							
	Actuator (<= 5Nm)	5s / 90°	31°	46°	62°	77°				
	Actuator <b>SQM33.7</b>	17s / 90°	<b>9° (1)</b>	13°	18°	22°				

(1) in this case the max. position of 90° can't be reached

545	Percentuale minima di carico per modulazione (valore fabbrica = n.d. - range impostazione:20%-100%)	Lower load limit (default value = n.d. - range:20%-100%)	OEM / Service	x	x	x
546	Percentuale massima di carico per modulazione (valore fabbrica = n.d. - range impostazione:20%-100%)	Higher load limite (default value = n.d. - range:20%-100%)	OEM / Service	x	x	x
565	Combustibile 1 - Percentuale minima di carico per modulazione (valore fabbrica = n.d. - range impostazione:20%-100%)	Fuel 1 Lower load limit (default value = n.d. - range:20%-100%)	OEM / Service		x	
566	Combustibile 1 - Percentuale massima di carico per modulazione (valore fabbrica = n.d. - range impostazione:20%-100%)	Fuel 1 Higher load limite (default value = n.d. - range:20%-100%)	OEM / Service		x	

**Block 600: Actuators**

Param.	Descrizione	Description	Password	LMV20 LMV27	LMV26	LMV37
601	Impostazione punto di riferimento <b>Indice 0</b> = combustibile <b>Indice 1</b> = aria <b>0</b> = chiuso (<0°) <b>1</b> = aperto (>90°)	Selection of reference point <b>Index 0</b> = fuel <b>Index 1</b> = air <b>0</b> = closed (<0°) <b>1</b> = open (>90°)	OEM	x	x	x
602	Direzione rotazione del servocomando <b>Indice 0</b> = combustibile <b>Indice 1</b> = aria <b>0</b> = antiorario <b>1</b> = orario VEDI MESSAGGIO DI "ATTENZIONE" RIPORTATO SOTTO.	Actuator's direction of rotation <b>Index 0</b> = fuel <b>Index 1</b> = air <b>0</b> = counterclockwise <b>1</b> = clockwise SEE "WARNING" MESSAGE QUOTED BELOW.	OEM	x	x	x
606	Limite tolleranza per monitoraggio posizione (0.1°) <b>Indice 0</b> = combustibile <b>Indice 1</b> = aria	Tolerance limit of position monitoring (0.1°) <b>Index 0</b> = fuel <b>Index 1</b> = air	OEM / Service	x	x	x
608	Combustibile 1 - Impostazione punto di riferimento <b>Indice 0</b> = combustibile <b>Indice 1</b> = aria <b>0</b> = chiuso (<0°) <b>1</b> = aperto (>90°)	Fuel 1 : Selection of reference point <b>Index 0</b> = fuel <b>Index 1</b> = air <b>0</b> = closed (<0°) <b>1</b> = open (>90°)	OEM		x	
609	Combustibile 1 - Direzione rotazione del servocomando <b>Indice 0</b> = combustibile <b>Indice 1</b> = aria <b>0</b> = antiorario <b>1</b> = orario VEDI MESSAGGIO DI "ATTENZIONE" RIPORTATO SOTTO.	Fuel 1 : Actuator's direction of rotation <b>Index 0</b> = fuel <b>Index 1</b> = air <b>0</b> = counterclockwise <b>1</b> = clockwise SEE "WARNING" MESSAGE QUOTED BELOW.	OEM		x	
610	Combustibile 1 - Limite tolleranza per monitoraggio posizione (0.1°) <b>Indice 0</b> = combustibile <b>Indice 1</b> = aria	Fuel 1 : Tolerance limit of position monitoring (0.1°) <b>Index 0</b> = fuel <b>Index 1</b> = air	OEM / Service		x	

611	<p>Tipo di riferimento dei servocomandi  index 0 = fuel (default = 0 (riferimento standard))  index 1 = air (default = 0 (riferimento standard))  0 = standard  1 = fermo entro il raggio utile  2 = fermi interni (SQN1...)  3 = entrambi</p>	<p>Type of referencing  Index 0 = fuel  Index 1 = air  0 = standard  1 = stop within usable range  2 = internal stop (SQN1...)  3 = both</p>	OEM	x	x	x
612	<p>Combustibile 1 - Tipo di riferimento del servocomando combustibile  0 = standard  1 = fermo entro il raggio utile  2 = fermi interni (SQN1...)  3 = entrambi</p>	<p>Fuel 1:  Type of reference for fuel actuator  0 = standard  1 = range stop in the usable range  2 = internal range stop (SQN1...)  3 = both</p>	OEM		x	
613	<p>Tipo di servocomando  <b>Indice 0</b> = combustibile  <b>Indice 1</b> = aria  0 = 5s / 90° (1Nm, 1,2Nm, 3Nm)  1 = 10s / 90° (6Nm)  2 = 17s / 90° (10Nm)</p>	<p>Type of actuator  <b>Index 0</b> = fuel  <b>Index 1</b> = air  0 = 5 s / 90° (1Nm, 1,2Nm, 3Nm)  1 = 10 s / 90° (6Nm)  2 = 17 s / 90° (10Nm)</p>	OEM	x	x	x
614	<p>Combustibile 1 :Tipo di servocomando  <b>Indice 0</b> = combustibile  <b>Indice 1</b> = aria  0 = 5s / 90° (1Nm, 1,2Nm, 3Nm)  1 = 10s / 90° (6Nm)  2 = 17s / 90° (10Nm)</p>	<p>Fuel 1 : Type of actuator  <b>Index 0</b> = fuel  <b>Index 1</b> = air  0 = 5 s / 90° (1Nm, 1,2Nm, 3Nm)  1 = 10 s / 90° (6Nm)  2 = 17 s / 90° (10Nm)</p>	OEM		x	
641	<p>Attivazione procedura di standardizzazione inverter (riferirsi al codice errore 82)  0 = standardizzazione disattivata  1 = standardizzazione attivata</p>	<p>Control of speed standardization of VSD Error diagnostics of negative values (refer to error code 82)0 = no speed standardization 1 = speed standardization active</p>			x	x

645	Configurazione uscita analogica % di carico (valore fabbrica = 0) <b>0</b> = DC 0..10 V <b>1</b> = DC 2..10 V <b>2</b> = DC 0/2..10 V	Configuration of analog output (default value = 0) <b>0</b> = DC 0..10 V <b>1</b> = DC 2..10 V <b>2</b> = DC 0/2..10 V	OEM / Service	LMV27	x	x
-----	---	--	---------------	-------	---	---



**ATTENTION:** as for SQM3x actuators, set the direction according to the acuator function. As far as SQN1x actuators, set **always** the counterclockwise direction, independenty from the model chosen for the specific function.

**Block 700: Error history**

<b>Param.</b>	<b>Descrizione</b>	<b>Description</b>	<b>Password</b>
701	Storico errori: 701 - 725.01.codice	Error history: 701 - 725.01.code	Service / Info
°	Storico errori: 701 - 725.02.codice diagnostico	Error history: 701 - 725.02.diagnostic code	Service / Info
°	Storico errori: 701 - 725.03.classe errore	Error history: 701 - 725.03.error class	Service / Info
°	Storico errori: 701 - 725.04.fase	Error history: 701 - 725.04.phase	Service / Info
°	Storico errori: 701 - 725.05.contatore avvii	Error history: 701 - 725.05.startup counter	Service / Info
725	Storico errori: 701 - 725.06.carico	Error history: 701 - 725.06.load	Service / Info

**Block 900: Process data**

Param.	Descrizione	Description	Password
903	Potenza attuale (valore fabbrica = 0% - range impostazione = 0-100%) <b>Indice 0</b> = combustibile <b>Indice 1</b> = aria	Current output (default value = 0% - range = 0-100%) <b>Index 0</b> = fuel <b>Index 1</b> = air	Service / Info
922	Posizione incrementale servocomandi (valore fabbrica = 0% - range impostazione = -50% - 150%) <b>Indice 0</b> = combustibile <b>Indice 1</b> = aria	Incremental position of actuators (default value = 0% - range = -50% - 150%) <b>Index 0</b> = fuel <b>Index 1</b> = air	Service / Info
935	Giri motore assoluti	Absolute speed	OEM / Service
936	Giri motore in fase standardizzazione	Standardized speed	Service / Info
942	Sorgente potenza attiva	Active load source	OEM / Service
945	Solo con <b>LMV26</b> : Combustibile attuale 0 = combustibile 0 1 = combustibile 1	Actual fuel 0 = fuel 0 1 = fuel 1	Service / Info
947	Risultato interrogazione contatti (codifica bit)	Result of contact sensing (bit-coded)	Service / Info
950	Stato relè (codifica bit)	Required relay state (bit-coded)	Service / Info
954	Intensità di fiamma ( 0% ÷ 100%); minima corrente 30% = 4µA; massima corrente 100% = 16µA; massima corrente ammissibile = 40µA.	Intensity of flame (range = 0% - 100%) minimum current 30% = 4µA; maximum current 100% = 16µA; maximum current possible = 40µA.	Service / Info
961	Stato moduli esterni e display	Status of external modules and display	Service / Info
981	Errore memoria: codice	Error memory: code	Service / Info
982	Errore memoria: codice diagnostica	Error memory: diagnostic code	Service / Info
992	Flag di errore	Error Flags	OEM / Service

## Actuators references

An incremental transducer is used to ensure position feedback. Referencing of the actuators must be performed after power-on. In addition, at the end of each shutdown in phase 10, the actuators are referenced to ensure that individual stepping errors, which could lead to shutdown, do not accumulate. If a position error occurs, the system switches to the safety phase (phase 01), enabling the actuators with detected position errors to be referenced. During the following phase 10, the only actuators that are referenced are those that were not referenced before in the safety phase (phase 01). The position of the reference point can be selected depending on the type of burner design, either the CLOSED position ( $<0^\circ$ ) or the OPEN position ( $>90^\circ$ ).

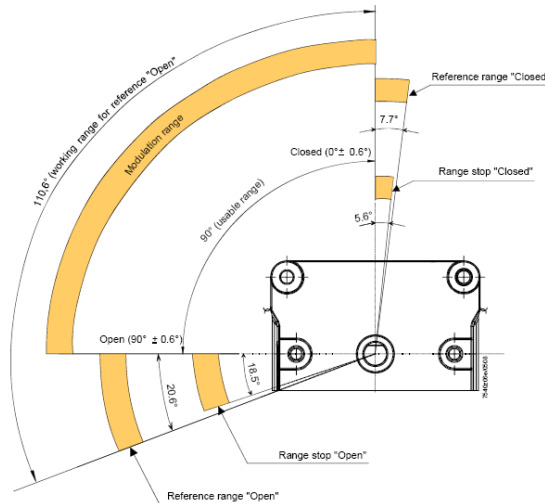

Param.	Descrizione	Description	Password
601	Impostazione punto di riferimento <b>Indice 0</b> = combustibile <b>Indice 1</b> = aria <b>0</b> = chiuso ( $<0^\circ$ ) <b>1</b> = aperto ( $>90^\circ$ )	Selection of reference point <b>Index 0</b> = fuel <b>Index 1</b> = air <b>0</b> = closed ( $<0^\circ$ ) <b>1</b> = open ( $>90^\circ$ )	OEM

If the actuators position is exchanged (error code: 85), the burner will lockout and will try to adjust for three times, then it will lock out.

## Gas proving system

Valve proving is only active when firing on gas. This is a leakage test designed to detect leaking gas valves and, if necessary, to prevent the valves from opening or ignition from being switched on. Lockout is initiated. When performing valve proving, the gas valve on the burner side is opened first to bring the test space to atmospheric pressure. Then, the valve is closed whereupon the pressure in the test space must not exceed a certain level, measured by the gas leakage pressure switch (PGCP). Then, the gas valve on the mains side is opened to fill the gas pipe. When the valve is closed again, the gas pressure must not drop below a certain level. Valve proving can be parameterized to take place on startup, shutdown, or on both phases.

## Air-fuel curve points

There are 10 air-fuel curve points: T

P0 = ignition position. Only for ignition; after the ignition, the burner works between Point P1 (low flame) and point P9 (high flame) without going back to P0.

P0 can be set everywhere irrespective of all the other points.

## COMMISSIONING THE BURNER

The LMV2x complete programming must be performed on units that has never been set before or reset units (e.g. spare parts).

The programming procedure is performed by setting the following main parameters:

- 1 if LMV.. is a spare part, insert burner ID (parameter **113**) at least 4 digit.
- 2 type of fuel train (parameter "**201**")
- 3 air/fuel ratio curvepoints (Block "**400**")
- 4 maximum load percentage (parameter "**546**")
- 5 minimum load percentage (parameter "**545**")



CAUTION: if an error message as "Loc.." appears when the unit is turned to on for the first time, press ENTER (InFo) until the "Reset" message apperas. After few seconds, the message "OffUpr" will be displayed.

This message shows that the unit has not been programmed before or that the operating mode (fuel train) is not set yet or that the unit has not been completely programmed. Pree keys **F** (Fuel) and **A** (Air)  at the same time until the display shows **code** and next it will show 7 bars the first on the left is flashing. If the display shows "Off", it means that the unit is already set, then see the instructions on chapter "Adjsuting the burner with LMV2x already programmed").

At the first LMV startup, the AZL display will show

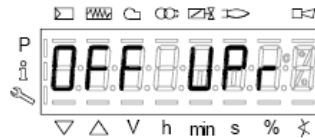

It means that the unit was never set or that no mode was chosen or that some parameters have to be set further.

Push F (fuel) and A (Air) together until the display shows **code** and then a 7 digit dashed line blinking on the left.



Press the "+" key until the first character of the password (the default password is 9876), then press **ENTER (InFo)**, the character now turn to a bar while the second bar starts flashing. Press "+" until the second character is entered, then press **ENTER (InFo)**.

Repeat the procedure until the last character is set, then press **ENTER (InFo)**, then **ENTER** again until the message **PaRA** appears: then the first parameters block ("**400**") will be shown:



Press **ENTER (InFo)** again, to gain access to programming the operating mode (fuel train):

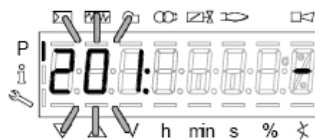

In the example, set configuration **1** = direct gas ignition (G mod).

Other possibilities are below listed:

the types of fuel trains are the following:

Param.	Descrizione	Description	Password
201	<p>Modalità funzionamento bruciatore ( rampa comb., mod. / multistadio, servocom., ecc.)            ___ = non definito (cancellazione curve) ___ =  <b>1</b> = accensione diretta a gas (G mod)  <b>2</b> = accensione tramite pilota gas con attacco tra le due elettrovalvole EV1/EV2 gas (Gp1 mod)  <b>3</b> = accens. tramite pilota gas con attacco a monte dell'elettrov. EV1 del gas (Gp2 mod)  <b>4</b> = accensione a gasolio - modul. (Lo mod)  <b>5</b> = accens. a gasolio - bistadio (Lo 2 stage)  <b>6</b> = accens. a gasolio - tristadio (Lo 3 stage)</p>	<p>Burner operating mode (fuel train, mod / multi-stage, actuators, etc.)            ___ = undefined (delete curves)  <b>1</b> = gas direct ignition(G mod)  <b>2</b> = gas pilot ignition with connection between the two gas solenoid valves EV1/EV2 (Gp1 mod)  <b>3</b> = gas pilot ignition with connection upstream the gas solenoid valve EV1 (Gp2 mod)  <b>4</b> = Light Oil - modulating (Lo mod)  <b>5</b> = Light Oil - 2stages (Lo 2 stage)  <b>6</b> = Light Oil - 3stages (Lo 3 stage)</p>	OEM / Service

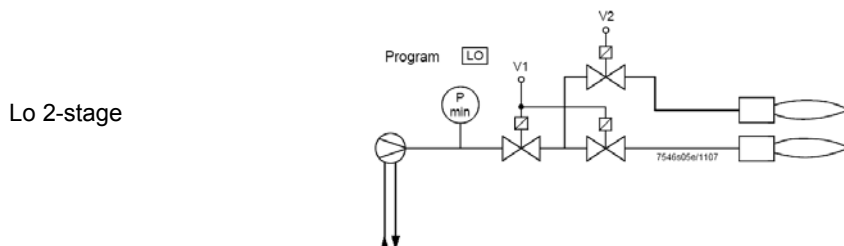
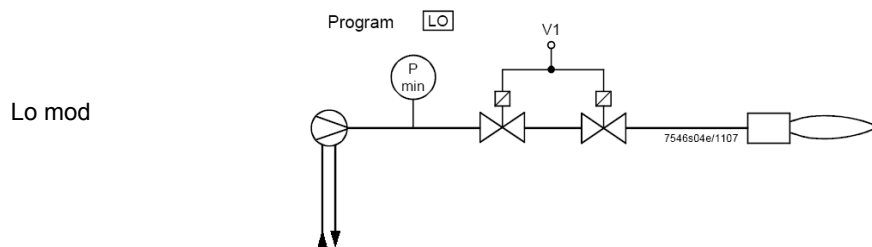
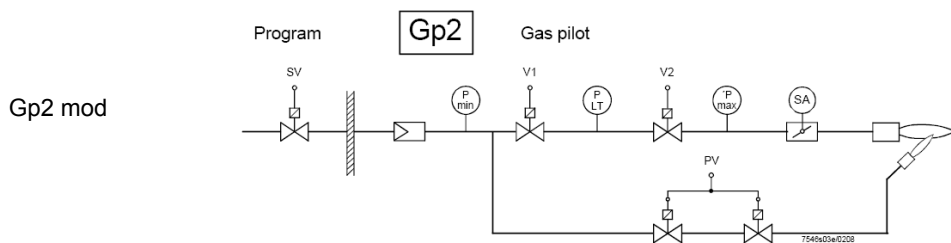
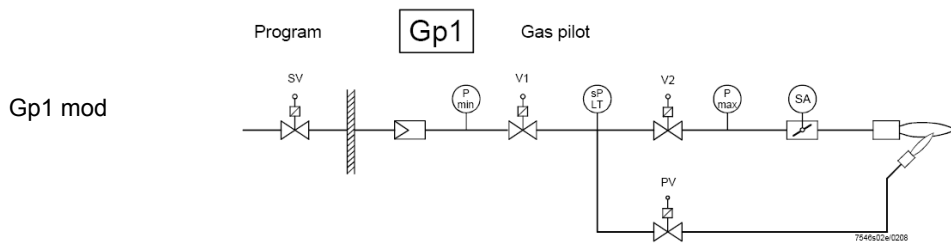
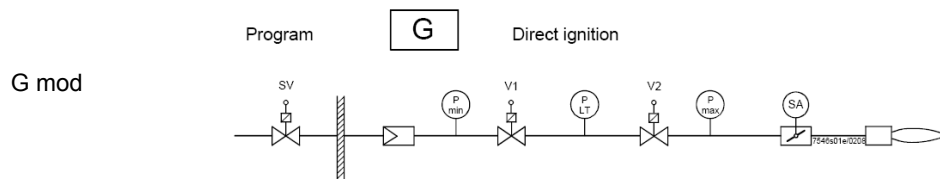

Lo 3-stage

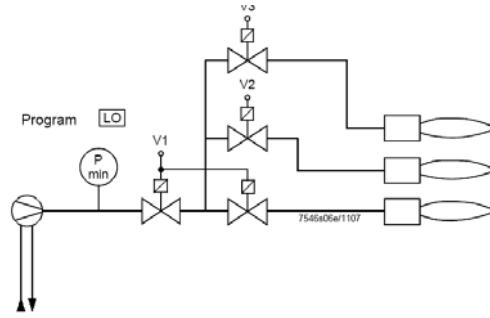

In the example the Gmod gas train has been set (Configuration "1").

Choose the fuel train by pressing ENTER, then press "+" / "-". Press ENTER to confirm: number "1" will appear on the right side of the display.

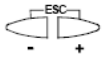

Then press ESC to quit. The following display is:



Press "+" to show the first point to be set P0.

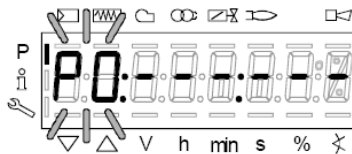

Press F and "+" to increase the opening angle of the fuel actuator "OF" until the requested value is reached (for example 12°±15°, see below) for the ignition point; or press F and "-" to decrease the angle:

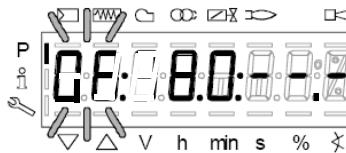

To set the air damper opening angle "OA" in the ignition point (10° for example - see below), press "A" and "+" "A" and "-" at the same time:

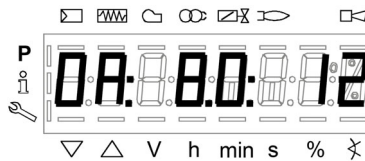

LMV37:

Now the air and fuel quantities are set at the ignition point P0:

By pressing "+", point P9 can be programmed to set the air and fuel values at the maximum output

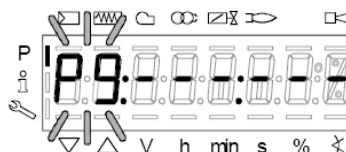

go on as described above to the the opening angles of the air actuator (A) and fuel actuator (F):

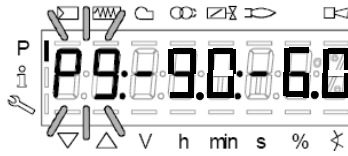

**CAUTION:** at the first burner adjustment, it is recommended to set the maximum output P9 at the same value (or little higher) of the ignition point, in order to safely reach point P9 next (see next paragraph).

By pressing “+” the display will show:

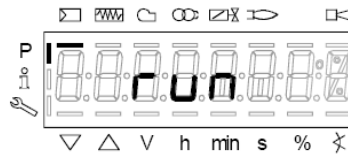

The burner is ready to startup. Now it is possible to re-set the curve points while the burner is operating (“warm setting”) by pressing the ENTER (InFo) or while the burner is in stand-by mode (“cold setting”) by pressing ENTER .

## Warm setting

- 1 Once pressed button “enter” and the chain thermostats open (X5-03 terminals), the LMV.. show Ph12. Then close the chain thermostat and the unit performs the prepurge cycle (see “Phases List”) and stops at the ignition point P0 without ignition anyway.
- 2 By pressing “+”, the burners lights and the air/fuel ratio can be properly set in presence of flame.
- 3 By pressing “+” again, the next point P1 is shown (equal to P0 as the unit automatically set P0=P1);
- 4 By pressing “+” again, the “Calc” message will be displayed: the unit is processing the air/fuel ratio curvepoints until point P9, previously set. Once the processing is performed the calculated point P2 is shown. By pressing “+” again, the “Calc” message will be displayed: the unit is processing the air/fuel ratio curvepoints until point P9, previously set. Once the processing is performed the calculated point P2 is shown.
- 5 By pressing “+”, it is possible to go through the processed curve until point P9 is reached.

**Note:** if the point doesn't blink, servomotors are still running.

- 6 In order to set P9 with the gas flow rate according to the generator needs, follow this procedure:

**Note: the purpose is to fully open the gas throttle and later on to adjust the gas flow rate through the gas pressure governor.**

- Operate smoothly opening by just a few degrees the air damper and later on increasing the gas throttle opening it by a few degrees. Keep monitoring the flue through the flue analyser. Keep the air excess inside normal figures (from 3% to 7% residual O<sub>2</sub>) operating by means for the air damper servomotor;
- Keep increasing the air damper opening and then the gas throttle, as done in the sequence above, remembering to get the full firing rate with the gas throttle fully open (or the oil pressure regulator at its maximum pressure position).

See example below:

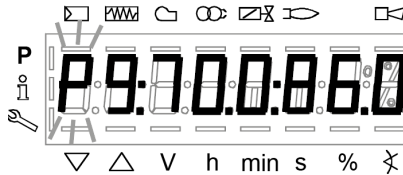

- If, while opening the gas throttle, the gas flow rate was too high, reduce it only through the gas governor and keep opening the throttle until the 60÷70° position is got.
  - If the gas train is equipped with a governor and a valve with an adjustable gas flow rate, fully open also this last valve, smoothly! The gas flow rate is always set by means of the governor.
- 7 As soon as all the devices are fully open, set the gas flow rate through the governor.
  - 8 Set the air damper position in order to get the recommended air excess (3÷4.8% O<sub>2</sub> on gas and 2.9÷4.9 % on oil).

**Note1:** on high flame, if the gas flow rate is changed by means of the governor, all the other points below high flame must be checked again.

- 9 After having set the high flame point P9, keep “-” pressed for some seconds until “Calc” is displayed in order to have the LMV recalculating all the points:

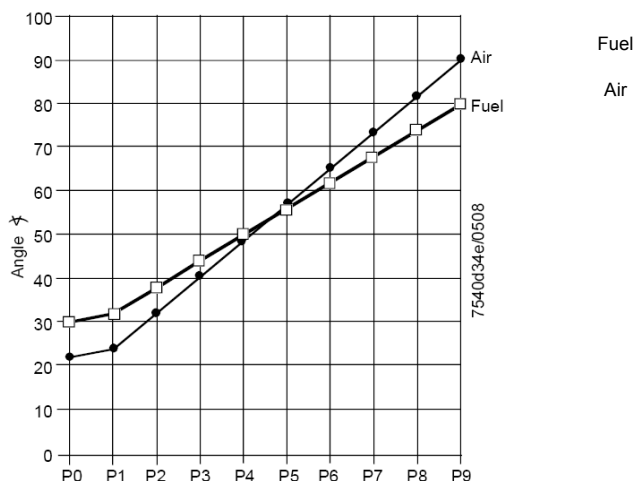

- 10 the unit will automatically reach point P8 processed: check the combustion values in this point and, if necessary, change it.
- 11 Press “-” to go down to the lower points and check the combustion values, change the points if necessary.

**Note:** if in an intermediate point (for example P5), the change of the actuators position is important according to the processed point

P5, keep pressing “-” until “Calc” is displayed. The curve will be processed again downwards point P1.

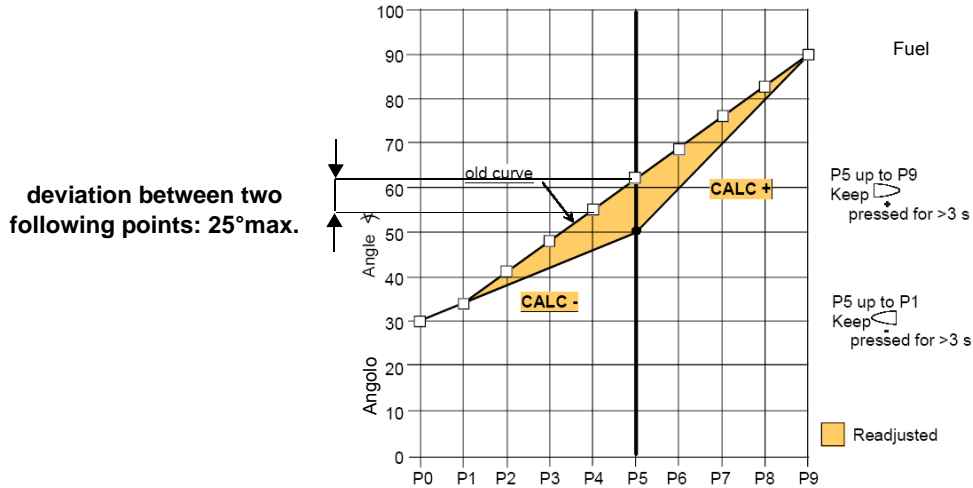

- 12 press “-” to go through the lower points and check the combustion values, if necessary change the points as described above.
- 13 By pressing ESC, at the end of the points adjustments, the parameter “546” (setting the maximum load) will be displayed; press ENTER (InFo), then “+” until 100%, then press ENTER (InFo) again, ESC and then “+”.

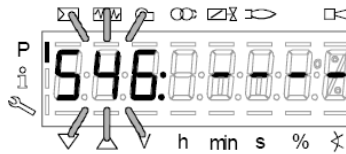

- 14 The parameter “545” (setting the minimum load) is displayed: press ENTER (InFo), then “+” until 20%. Press ENTER, then press ESC for three times. The message “oP” will be displayed as well as the load percentage at the burner is working on.

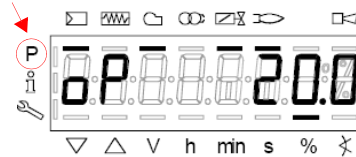

The hyphen related to the symbol “P” (highlighted in the picture) will be off to show that the unit exited the programming mode. The burner will then work automatically, following the curve set.

**Note1:** if the curvepoints settings is quit before end (by pressing ESC or for a faulty shutdown), the message “OFF UPr” (Start prevention) will be displayed until all the curvepoints will be set.

**Note2:** if the gas flow rate at high flame point (maximum load) is changed by means of the pressure stabiliser, all the curvepoints must be checked by going through the curve downwards and resetting them if necessary.

**Note3:** if the point does not flash, it means that the actuators have not reached the set position yet.

**Note4:** if an error occurs causing a safety shutdown during the processing of the curve, the processing itself will be interrupted.

### Cold setting

The “cold setting” (without flame) can be performed only when all the curve points values are known (for instance, in case of replacement).

	<p>When the burner is off, if you modify one curve set point, when the burner restarts the AZL2x shows OFF UPr (OFF UPr0 or OFF UPr1 for LMV26). The LMV.. then, requires a new “warm” startup (see procedure paragraph “Warm Setting”) by checking again all points of curve from P0 to P9.</p>
--	--

## BURNER STARTUP WITH LMV2x ALREADY PROGRAMMED

Once the LMV turns on, the AZL display will show

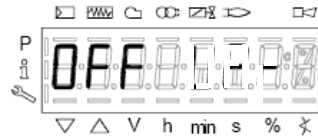

The burners is basically factory set. The air/fuel ratio curve is set with the maximum output point P9 a little higher or equal to P0. To adjust the burner on the plant site, adjust the maximum output point to the flow rate values really requested. Then go through the curve-points, by pressing “+” several times to reach point P9: then adjust the air actuator position (for the air damper) and the fuel actuator (for the butterfly valve, in case of gas or the oil pressure governor incase of oil), by adjusting the fuel flow rate by means of the gas pressure stabiliser (for gas) or the oil pressure governor (for oil), checking the combustion valeus contemporarily. Once the burner is adjusted at the maximum output, press “-” for more than 5 seconds to process the curve downwards. The curve is then a straight line: go on checking the combustion values point by point; change them if necessary and in case linearise the curve again.

Before starting the burner up, press **F** and **A** at the same time





enter the password following the procedure on chapter “Programming LMV2x”.

Press ENTER until the display will show:

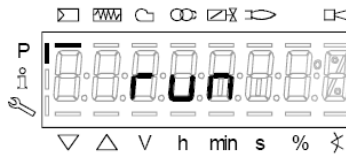

Press ENTER again: it will show



press ENTER (Info)  : the display will show phase 12.

Ph12: *Standby* phase (stationary)

Ph12: *Standby* phase (stationary)

By closing the thermostatic series, the burner startup cycle will take place:

Ph22: *Fan ramp up* phase (fan motor = ON, safety shutoff valve = ON)

Ph24: *Traveling to prepurge position* phase

Ph30: *Prepurge* phase

Ph36: *Traveling to ignition position* phase

Ph38: *Preignition* phase

Ph40: *1st safety time* phase (ignition transformer ON)

Ph42: *1st safety time* phase (ignition transformer OFF), preignition time OFF

Ph44: *Interval1*

The startup sequence stops at phase 44.

**The burners is lit and is in “P1” position (low flame point):**



Set the air/fuel ratio curvepoints as described on chapter “Programming the LMV2x”

**Note:** the other phases are

Ph60 = operation (OP= in modulation)

Ph62 = travelling to shutdown

Ph70 = off but in prepurge after the burntime

Ph72 = travelling to postpurging

Ph74 = postpurge (countdown is displayed)

Press ESC  the parameter “546” (Setting the maximum load) is displayed

Then press  to exit the programming mode.

The display will show:

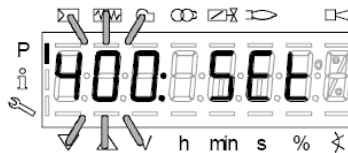

Press  for a second time: the display will show the load percentage the burner is working at.

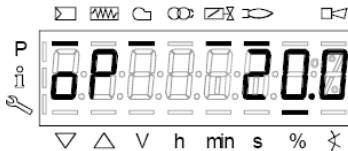

When the generator reaches the programmed set-point, the burner will be in stand-by: the display will show

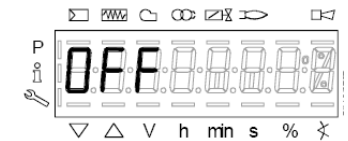

---

### **Reset / manual lockout**

The system can be manually locked by simultaneously pressing the **ENTER (InFo)** button and **any other button** on the AZL2.... This function allows the user to stop the system from the operating level should an emergency occur. When making a reset, the following actions are carried out:

- Alarm relay and the fault display are off
- the lockout position is cancelled
- the unit performs a reset, then it switches to stand-by

If the unit is in the lockout position, a reset can be made by pressing the **InFo** button for 1...3 seconds. The function is available only when the unit is in the lockout position. Longer or shorter pushes on the button do not produce a reset so that the system maintains the lockout position.

<b>Codice errore / Error code</b>	<b>Codice diagnostico / Diagnostic code</b>	<b>Descrizione / Meaning</b>
167	2	/ Manual lockout via AZL2...

### **Timeout for menu operation**

The time for automatically leaving the parameter setting level can be adjusted between 10 and 120 minutes, using the parameter 127 (Timeout for menu operation). If, during that period of time, there is no operation via the AZL2..., the parameter setting level is quit and the password level reset to *Info / Service*.

**Caution! In addition, this timeout or interruption of communication between the LMV2.. and the AZL2... during the time the curves are set leads to lockout!**

<b>Codice erroreC Error code</b>	<b>Codice diagnostico Diagnostic code</b>	<b>DescrizioneMeaning</b>
167	8	Manual locking



## Info level

To enter the **Info** level, proceed as follows:

- 1 in any menu position, press keys **+** and **-** at the same time, then the program will start again: the display will show **OFF**.

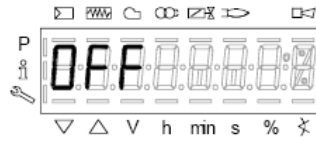

- 2 , until the display will show **InFo**, Press the **enter (InFo)** key



- 3 then it will show the first code (167) flashing, on the right side it will show the data entered. By pressing **+** or **-** it is possible to scroll (up or down) the parameter list.
- 4 If a dot-line is shown on the right, there is no enough room for complete visualisation: press **enter** again the data will be completely shown for 1 to 3 seconds. By pressing **enter** or **+** and **-** at the same time, the system will exit the parameter visualisation and go back to the flashing number. The **Info** level shows some basic parameters as:

Parameter	Description
167	Cubic meters of fule (resettable)
162	Operating hours (resettable)
163	Device operating hours
164	Burners start-ups (resettable)
166	Total number of start-ups
113	Burner number (i.e. serial number)
107	Software version
102	Software date
103	Device serial number
104	Customer code
105	Version
143	Free

- 5 Example: choose parameter 102 to show the date

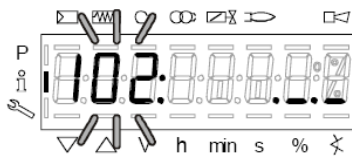

the display shows parameter **102** flashing on the left and characters **.\_.** on the right.

- 6 press **InFo** for 1-3 seconds: the date will appear
- 7 press **InFo** to go back to parameter "102"
- 8 by pressing **+** / **-**, it is possible to scroll up/down the parameter list (see table above), or, by pressing **ESC** or **InFo** for more seconds, the display will show
- 9 Once the last parameter is accessed (143) by pressing **+**, the **End** message will flash.

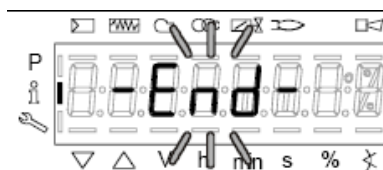

10 Press **InFo**  for more than three seconds or for more than three seconds orto return to the normal display.

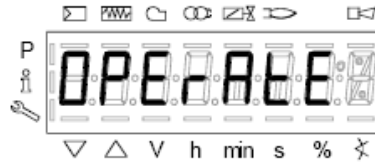

If a message like the one below is shown during operation,

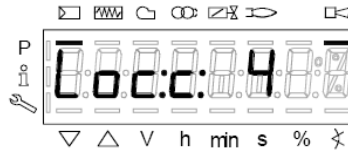

it means that the burner is locked out and the Error code is shown (in the example “error code:4”); this message is alternating with another message

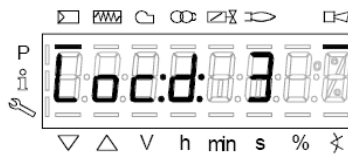

Diagnostic code (in the example “diagnostic code:3”). Record the codes and find out the fault in the Error table  
To perform the reset, press InFo for one second:



The unit displays an event which does not lead to shutdown.

The display shows current error code **c**: alternating with diagnostic code **d**:

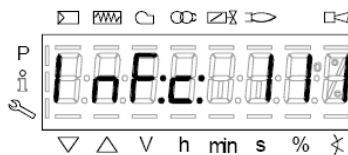

Press **InFo** to return to the display of phases.

Example: Error code **111** / diagnostic code **0**



To reset, press InFo for a second. Record the codes and check the Error List to find the type of faults.

### Service level

To enter the Service mode, press InFo until the display will show:



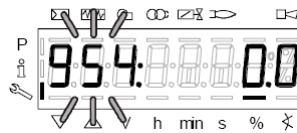

The service level shows all the information about flame intensity, actuators position, number and lock codes:

Parameter	Description
954	Flame intensity
121	% output, if set = automatic operation
922	Actuators position, 00=combustibile; 01= aria
161	Lock-outs number
701..725	Lock-outs History (see chapter 23 in the LMV2x manual)

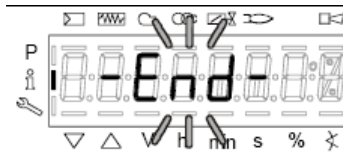

- 1 the first parameter will be "954": the percentage of flame is shown on the right. By pressing + or - it is possible to scroll up/down the parameter list.
- 2 Once the last parameter is accessed (143) by pressing + , the **End** message will blink.



- 3 Press **InFo**  for more than three seconds or for more than three seconds orto return to the normal display.



## PHASES LIST

Fase /Phase	Funzione	Function
Ph00	Fase blocco	Lockout phase
Ph01	Fase di sicurezza	Safety phase
Ph10	t10 = tempo raggiungimento posizione riposo	t10 = home run
Ph12	Pausa	Standby (stationary)
Ph22	t22 = tempo di salita ventilatore (motore ventilatore = ON, valvola intercettazione di sicurezza = ON)	t22 = fan ramp up time (fan motor = ON, safety shutoff valve = ON)
Ph24	Verso posizione preventilazione	Traveling to the prepurge position
Ph30	t1 = tempo preventilazione	t1 = prepurge time
Ph36	Verso posizione accensione	Traveling to the ignition position
Ph38	t3 = tempo preaccensione	t3 = preignition time
Ph40	TSA1 = primo tempo sicurezza (trasformatore accensione ON)	TSA1= 1st safety time (ignition transformer ON)
Ph42	TSA1 = primo tempo sicurezza (trasformatore accensione OFF)	TSA1 = 1st safety time (ignition transformer OFF), t42 = preignition time OFF
Ph44	t44 = intervallo 1	t44 = interval 1
Ph50	TSA2 = secondo tempo sicurezza	TSA2 = 2nd safety time
Ph52	t52 = intervallo 2	t52 = interval 2
Ph60	Funzionamento 1 (stazionario)	Operation 1 (stationary)
Ph62	t62 = massimo tempo bassa fiamma (funzionamento 2, in preparazione per spegnimento, verso bassa fiamma)	t62 = max. time low-fire (operation 2, preparing for shutdown, traveling to low-fire)
Ph70	t13 = tempo postcombustione	t13 = afterburn time
Ph72	Verso posizione postcombustione	Traveling to the postpurge position
Ph74	t8 = tempo postventilazione	t8 = postpurge time
Ph80	t80 = tempo evacuazione controllo tenuta valvole	t80 = valve proving test evacuation time
Ph81	t81 = tempo perdita pressione atmosferica, prova atmosferica	t81 = leakage time test time atmospheric pressure, atmospheric test
Ph82	t82 = test perdita, test riempimento	t82 = leakage test filling test, filling
Ph83	t83 = tempo perdita pressione gas, test pressione	t83 = leakage test time gas pressure, pressure test
Ph90	Tempo attesa "mancanza gas"	Gas shortage waiting time

## BACKUP PARAMETER WITH AZL2x

On the AZL2x you can save the configuration to download on another appliance LMV.

To do this:



access up, press **F** and **A** at the same time



enter the password following the procedure on chapter "Programming LMV2x".

Press ENTER until the display will show:



with the button  go to the group **000** of the parameters and press ; with the buttons **+** and **-** go to **050** parameter

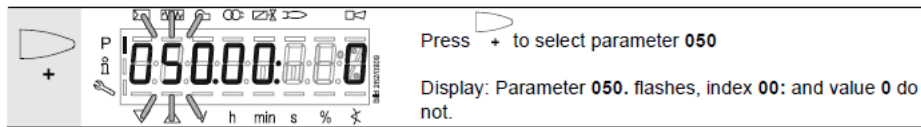

press  the display show  press again  with the button **+** select **1** and start the

backup process by pressing 

After about 5 seconds the backup process ends and the display shows

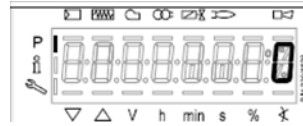

**It is recommended that you perform a backup procedure whenever you change the parameters of the LMV for having a copy in AZL2x!**

## RESTORE PARAMETER FROM AZL2x TO LMV..

To copy the previously saved configuration on AZL2x proceed as follows:  
access up, press **F** and **A** at the same time





enter the password following the procedure on chapter "Programming LMV2x".  
Press ENTER until the display will show:

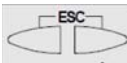
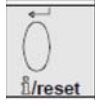

 **To copy the configuration from AZL2x to LMV. It is important that the type of LMV is the same (for example LMV20 with LMV20, etc.) and that 113 "Burner ID" of the burner is the same value that is saved in the configuration you want to copy.**

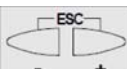

With the buttons  go to the group **100** of the parameters, press  and always with the buttons **+** and **-** go to

**113** parameter "Burner ID", press  and verify (and/or change with buttons by pressing enter to confirm)

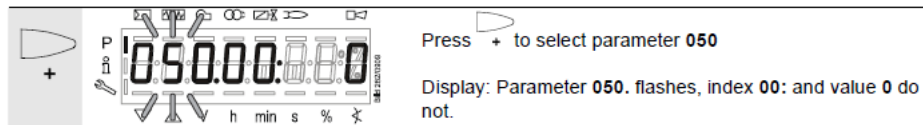
With the buttons  go to the group **000** of the parameters, press  and select the **050** parameter



press  the display show  with the button  the display shows

 press again  with the button **+** select **1** and start the restore process by pressing 



After about 5 seconds the restore process ends and the display shows   
Now, LMV has the same configuration that was stored on AZL2x.

## ERROR CODE TABLE

Error code	Diagnostic code	Meaning for the LMV2x/3x... system	Remedy
no Comm		No communication between LMV26... basic unit and AZL2...	Check wiring for line interruption/loose contact
2	#	<b>No flame at the end of safety time (TSA)</b>	
	1	No flame at the end of safety time 1 (TSA1)	
	2	No flame at the end of safety time 2 (TSA2)	
3	#	Air pressure failure	
	0	Air pressure off	
	1	Air pressure on	
	4	Air pressure on – prevention of startup	
	20	Air pressure, combustion pressure – start prevention	
	68	Air pressure, POC – start prevention	
	84	Air pressure, combustion pressure, POC – start prevention	
4	#	<b>Extraneous light</b>	
	0	Extraneous light during startup	
	1	Extraneous light during shutdown	
	2	Extraneous light during startup – prevention of startup	
	6	Extraneous light during startup, air pressure – start prevention	
	18	Extraneous light during startup, combustion pressure – start prevention	
	24	Extraneous light during startup, air pressure, combustion pressure – start prevention	
	66	Extraneous light during startup, POC – start prevention	
	70	Extraneous light during startup, air pressure, POC – start prevention	
	82	Extraneous light during startup, combustion pressure, POC – start prevention	
	86	Extraneous light during startup, air pressure, combustion pressure, POC – start prevention	
7	#	<b>Loss of flame</b>	
	0	Loss of flame	
	3...255	Loss of flame due to TÜV test (loss-of-flame test)	Diagnostics corresponds to the period of time from shutdown of fuel valves to the detection of loss of flame (resolution 0.2 s → Value 5 = 1 s)

Error code	Diagnostic code	Meaning for the LMV20... system	Remedy
<b>12</b>	#	<b>Valve proving</b>	
	0	<i>Fuel valve 1 (V1) leaking (fuel valve 2 with valve proving via X5-01)</i>	With valve proving via X5-01 (gas pressure switch-min) - Check if valve on the burner side is leaking - Check if pressure switch for valve proving is closed, if gas pressure exist - Check wiring for short-circuit
	1	<i>Fuel valve 2 (V2) leaking (fuel valve 1 with valve proving via X5-01)</i>	With valve proving via X5-01 (gas pressure switch-min) - Check if valve on the gas side is leaking - Check wiring for short-circuit
	2	<i>Valve proving not possible</i>	Valve proving activated, but pressure switch-min selected as input function for X9-04 (check parameters 238 and 241)
	3	<i>Valve proving not possible</i>	Valve proving activated, but no input assigned (check parameters 236 and 237)
	4	<i>Valve proving not possible</i>	Valve proving activated, but 2 inputs assigned (set parameter 237 to pressure switch-max or POC)
	5	<i>Valve proving not possible</i>	Valve proving activated, but 2 inputs assigned (check parameters 236 and 237)
	81	<i>V1 leaking</i>	Check to see if the valve on the gas side is leaking Check wiring to see if there is an open-circuit
	83	<i>V2 leaking</i>	Check to see if the valve on the burner side is leaking Check to see if the pressure switch for the leakage test is closed when gas pressure is present Check wiring for short-circuit
<b>14</b>	#	<b>POC</b>	
	0	<i>POC open</i>	Check to see if the valve's closing contact is closed
	1	<i>POC close</i>	Check wiring Check to see if the valve's closing contact opens when valve is controlled
	64	<i>POC open - start prevention</i>	Check wiring to see if there is a line interruption. Check to see if the valve's closing contact is closed
<b>19</b>	80	<i>Combustion pressure, POC – start prevention</i>	Check to see if pressure switch has closed with no combustion pressure present Check wiring for short-circuit
<b>20</b>	#	<b>Pressure switch-min (Pmin)</b>	
	0	<i>No minimum gas /oil pressure</i>	Check wiring for open-circuit
	1	<i>Gas shortage – start prevention</i>	Check wiring for open-circuit
<b>21</b>	#	<b>Pressure switch-max / POC</b>	
	0	<i>Pressure switch-max: Max. gas / oil pressure exceeded POC: POC open (software version ≤ V02.00)</i>	Check wiring to see if there is a line interruption. POC: Check to see if the valve's closing contact is closed.

Error code	Diagnostic code	Meaning for the LMV2x/3x... system	Remedy
<b>22</b>	<b>#</b>	<b>Safety loop / burner flange</b>	
<b>OFF S</b>	<b>0</b>	<i>Safety loop / burner flange open</i>	
	<b>1</b>	<i>Safety loop / burner flange open - prevention of startup</i>	
	<b>3</b>	<i>Safety loop/burner flange, extraneous light – start prevention</i>	
	<b>5</b>	<i>Safety loop/burner flange, air pressure – start prevention</i>	
	<b>17</b>	<i>Safety loop/burner flange, combustion pressure – start prevention</i>	
	<b>19</b>	<i>Safety loop/burner flange, extraneous light, combustion pressure – start prevention</i>	
	<b>21</b>	<i>Safety loop/burner flange, air pressure, combustion pressure – start prevention</i>	
	<b>23</b>	<i>Safety loop/burner flange, extraneous light, air pressure, combustion pressure – start prevention</i>	
	<b>65</b>	<i>Safety loop/burner flange, POC – start prevention</i>	
	<b>67</b>	<i>Safety loop/burner flange, extraneous light, POC – start prevention</i>	
	<b>69</b>	<i>Safety loop/burner flange, air pressure, POC – start prevention</i>	
	<b>71</b>	<i>Safety loop/burner flange, extraneous light, air pressure, POC – start prevention</i>	
	<b>81</b>	<i>Safety loop/burner flange, combustion pressure, POC – start prevention</i>	
	<b>83</b>	<i>Safety loop/burner flange, extraneous light, combustion pressure, POC – start prevention</i>	
	<b>85</b>	<i>Safety loop/burner flange, air pressure, combustion pressure, POC – start prevention</i>	
	<b>87</b>	<i>Safety loop/burner flange, extraneous light, air pressure, combustion pressure, POC – start prevention</i>	
<b>50</b>	<b>#</b>	<b>Internal error</b>	Make a reset; if error occurs repeatedly, replace the unit
<b>51</b>	<b>#</b>	<b>Internal error</b>	Make a reset; if error occurs repeatedly, replace the unit
<b>55</b>	<b>#</b>	<b>Internal error</b>	Make a reset; if error occurs repeatedly, replace the unit
<b>56</b>	<b>#</b>	<b>Internal error</b>	Make a reset; if error occurs repeatedly, replace the unit
<b>57</b>	<b>#</b>	<b>Internal error</b>	Make a reset; if error occurs repeatedly, replace the unit

Error code	Diagnostic code	Meaning for the LMV2x/3x... system	Remedy
58	#	Internal error	Make a reset; if error occurs repeatedly, replace the unit
61 Fuel Chg	#	Fuel changeover	
Fuel Chg	0	Fuel 0	No error - change to Fuel 0
Fuel Chg	1	Fuel 1	No error - change to Fuel 1
62 Fuel Err	#	Invalid fuel signals / fuel information	
Fuel Err	0	Invalid fuel selection (Fuel 0 + 1 = 0)	Check wiring to see if there is an open-circuit  Note Curves cannot be set.
Fuel Err	1	Different fuel selection between the $\mu$ Cs	Make a reset; if error occurs repeatedly, replace the unit
Fuel Err	2	Different fuel signals between the $\mu$ Cs	Make a reset; if error occurs repeatedly, replace the unit
Fuel Err	3	Invalid fuel selection (Fuel 0 + 1 = 1)	Check wiring for short-circuit  Note Curves cannot be set. LMV26...: Optional press reset button >3 seconds.
65	#	Internal error	Make a reset; if error occurs repeatedly, replace the unit
66	#	Internal error	Make a reset; if error occurs repeatedly, replace the unit
67	#	Internal error	Make a reset; if error occurs repeatedly, replace the unit
70	#	Internal error fuel-air ratio control: Position calculation modulating	
	23	Output invalid	No valid output
	26	Curvepoints undefined	Adjust the curvepoints for all actuators
71	#	Special position undefined	
	0	Home position	Parameterize the home position for all actuators used
	1	Prepurge position	Parameterize the prepurge position for all actuators used
	2	Postpurge position	Parameterize the postpurge position for all actuators used
	3	Ignition position	Parameterize the ignition position for all actuators used
72	#	Internal error fuel-air ratio control	Make a reset; if error occurs repeatedly, replace the unit
73	#	Internal error fuel-air ratio control: Position calculation multistep	
	23	Output invalid	No valid output
	26	Curvepoints undefined	Adjust the curvepoints for all actuators

Error code	Diagnostic code	Meaning for the LMV2x/3x... system	Remedy
75	#	<b>Internal error fuel-air ratio control: Data clocking check</b>	
	1	<i>Current output different</i>	
	2	<i>Target output different</i>	
	4	<i>Target positions different</i>	
	16	<i>Different positions reached</i>	Can be caused by different standardized speeds (e.g. after restore of data set) when the VSD is activated → standardize again and check adjustment of the fuel-air ratio control system
76	#	<b>Internal error fuel-air ratio control</b>	Make a reset; if error occurs repeatedly, replace the unit
80	#	<b>Control range limitation of VSD</b>	Basic unit could not correct the difference in speed and reached a control range limit. 1. Basic unit is not standardized for this motor → repeat standardization.  <b>Caution!</b> <b>Settings of fuel-air ratio control must be checked.</b> 2. Ramp time settings of the VSD are not shorter than those of the basic unit (parameters 522, 523). 3. Characteristic of the VSD is not linear. Configuration of the voltage input at the VSD must accord with that of the basic unit (parameter 645). 4. VSD does not follow quickly enough the changes of the basic unit. Check settings of the VSD (input filter, slippage compensation, hiding different speeds)
	1	<i>Control range limitation at the bottom</i>	VSD speed was too high
	2	<i>Control range limitation at the top</i>	VSD speed was too low
	1	<i>Interrupt limitation speed input</i>	Too much electromagnetic interference on the sensor line → improve EMC

Error code	Diagnostic code	Meaning for the LMV2x/3x... system	Remedy
82	#	<b>Error during VSD's speed standardization</b>	
	1	<i>Timeout of standardization (VSD ramp down time too long)</i>	Timeout at the end of standardization during ramp down of the VSD → ramp time settings of the VSD are not shorter than those of the basic unit (parameter: 523)
	2	<i>Storage of standardized speed not successful</i>	Error during storage of the standardized speed → lock the basic unit, then reset it and repeat the standardization
	3	<i>Line interruption speed sensor</i>	Basic unit receives no pulses from the speed sensor: 1. Motor does not turn. 2. Speed sensor is not connected. 3. Speed sensor is not activated by the sensor disk (check distance)
	4	<i>Speed variation / VSD ramp up time too long / speed below minimum limit for standardization</i>	Motor has not reached a stable speed after ramp up. 1. Ramp time settings of the VSD are not shorter than those of the basic unit (parameters 522, 523). 2. Characteristic of the VSD is not linear. Configuration of the voltage input at the VSD must accord with that of the basic unit (parameter 645). 3. VSD does not follow quickly enough the changes of the basic unit. Check settings of the VSD (input filter, slippage compensation, hiding different speeds) 4. Speed of VSD lies below the minimum for standardization (650 1/min)
	5	<i>Wrong direction of rotation</i>	Motor's direction of rotation is wrong. 1. Motor turns indeed in the wrong direction → change parameterization of the direction of rotation or interchange 2 live conductors. 2. Sensor disk is fitted the wrong way → turn the sensor disk.
	6	<i>Unplausible sensor signals</i>	The required pulse pattern (60°, 120°, 180°) has not been correctly identified. 1. Speed sensor does not detect all tappets of the sensor disk → check distance 2. As the motor turns, other metal parts are detected also, in addition to the tappets → improve mounting. 3. Electromagnetic interference on the sensor lines → check cable routing, improve EMC
	7	<i>Invalid standardized speed</i>	The standardized speed measured does not lie in the permissible range → motor turns too slowly or too fast
	15	<i>Speed deviation <math>\mu C1 + \mu C2</math></i>	The speeds of microcomputer 1 and 2 deviated too much. This can be caused by wrong standardized speeds (e.g. after restoring a data set to a new unit) → repeat standardization and check the fuel-air ratio

Error code	Diagnostic code	Meaning for the LMV2x/3x... system	Remedy
	20	<i>Wrong phase of phase manager</i>	Standardization was made in a wrong phase. Permitted are only phases $\leq 12$ → controller OFF, start standardization again
	21	<i>Safety loop / burner flange open</i>	Safety loop or burner flange is open → repeat standardization with safety loop closed
	22	<i>Air actuator not referenced</i>	Air actuator has not been referenced or has lost its referencing. 1. Check if the reference position can be approached. 2. Check if actuators have been mixed up. 3. If error only occurs after the start of standardization, the actuator might be overloaded and cannot reach its destination.
	23	<i>VSD deactivated</i>	Standardization was started with VSD deactivated → activate the VSD and repeat standardization
	24	<i>No valid operating mode</i>	Standardization was started without valid operating mode → activate valid operating mode and repeat standardization
	25	<i>Pneumatic air-fuel ratio control</i>	Standardization was started with pneumatic air-fuel ratio control → standardization with pneumatic air-fuel ratio control not possible
	128	<i>Running command with no preceding standardization</i>	VSD is controlled but not standardized → make standardization
	255	<i>No standardized speed available</i>	Motor turns but is not standardized → make standardization

Error code	Diagnostic code	Meaning for the LMV2x/3x... system	Remedy
83	#	<b>Speed error VSD</b>	Required speed has not been reached
	Bit 0 Valency 1	<i>Lower control range limitation of control</i>	Speed has not been reached because control range limitation has become active → for measures, refer to error code 80
	Bit 1 Valency 2...3	<i>Upper control range limitation of control</i>	Speed has not been reached because control range limitation has become active → for measures, refer to error code 80
	Bit 2 Valency 4...7	<i>Interruption via disturbance pulses</i>	Speed has not been reached due to too much electromagnetic interference on the sensor line → for measures, refer to error code 81
	Bit 3 Valency ≥ 8	<i>Curve too steep in terms of ramp speed</i>	Speed has not been reached because detected curve slope was too steep. 1. With a LMV26... ramp of 20 s, the curve's slope may be a maximum of 10% speed change between 2 curvepoints in modulating mode. With a LMV26... ramp of 10 s, the curve's slope may be a maximum of 20% speed change between 2 curvepoints in modulating mode. With a LMV26... ramp of 5 s, the curve's slope may be a maximum of 40% speed change between 2 curvepoints in modulating mode. → Between the ignition point (P0) and the low-fire point (P1), the speed change in modulating mode may be a maximum of 40%, independent of the LMV26... ramp. 2. The setting of the VSD ramp must be about 20% faster than the ramps in the basic unit (parameters 522, 523).
	Bit 4 Valency ≥ 16	<i>Interruption of speed signal</i>	No speed detected in spite of control. 1. Check if the motor turns. 2. Check if the speed sensor delivers a signal (LED / check distance from the sensor disk). 3. Check wiring of the VSD.
	Bit 5 Valency ≥ 32	<i>Quick shutdown due to excessive speed deviation</i>	Speed deviation was for about 1 s >10% outside the anticipated range. 1. Check ramp times of the LMV26... and VSD. 2. Check wiring of the VSD.

Error code	Diagnostic code	Meaning for the LMV2x/3x... system	Remedy
<b>84</b>	<b>#</b>	<b>Curve slope actuators</b>	
	Bit 0 Valency 1	VSD: Curve too steep in terms of ramp speed	<ol style="list-style-type: none"> <li>The curve's slope may be a maximum of 10% speed change between 2 curvepoints in modulating operation, with a LMV26... ramp of 20 seconds The curve's slope may be a maximum of 20% speed change between 2 curvepoints in modulating operation, with a LMV26... ramp of 10 seconds The curve's slope may be a maximum of 40% speed change between 2 curvepoints in modulating operation, with a LMV26... ramp of 5 seconds → Between the ignition point (P0) and the low-fire point (P1), the speed change in modulating mode may be a maximum of 40%, independent of the LMV26... ramp.</li> <li>Setting of the VSD ramp must be about 20% shorter than the ramps in the basic unit (parameters 522 and 523)</li> </ol>
	Bit 1 Valency 2..3	Fuel actuator: Curve too steep in terms of ramp rate	The slope of the curve may be a maximum position change of 31° between 2 curvepoints in modulating mode
	Bit 2 Valency 4..7	Air actuator: Curve too steep in terms of ramp rate	The slope of the curve may be a maximum position change of 31° between 2 curvepoints in modulating mode
<b>85</b>	<b>#</b>	<b>Referencing error ones actuators</b>	
	0	Referencing error of fuel actuator	<p>Referencing of fuel actuator not successful. Reference point could not be reached.</p> <ol style="list-style-type: none"> <li>Check to see if actuators have been mixed up.</li> <li>Check to see if actuator is locked or overloaded.</li> </ol>
	1	Referencing error of air actuator	<p>Referencing of fuel actuator not successful Reference point could not be reached.</p> <ol style="list-style-type: none"> <li>Check to see if actuators have been mixed up.</li> <li>Check to see if actuator is locked or overloaded.</li> </ol>
	Bit 7 Valency ≥ 128	Referencing error due to parameter change	Parameterization of an actuator (e.g. the reference position) has been changed. To trigger new referencing, this error is set
<b>86</b>	<b>#</b>	<b>Error fuel actuator</b>	
	0	Position error	Target position could not be reached within the required tolerance band → check to see if actuator is locked or overloaded
	Bit 0 Valency 1	Line interruption	Line interruption detected at actuator's terminals → check wiring (voltage X54 across pin 5 or 6 and pin 2 >0.5 V)
	Bit 3 Valency ≥ 8	Curve too steep in terms of ramp rate	The slope of the curve may be a maximum position change of 31° between 2 curvepoints in modulating mode
	Bit 4 Valency ≥ 16	Step deviation in comparison with last referencing	<p>Actuator was overloaded or mechanically twisted.</p> <ol style="list-style-type: none"> <li>Check to see if the actuator is blocked somewhere along its working range.</li> <li>Check to see if the torque is sufficient for the application.</li> </ol>

Error code	Diagnostic code	Meaning for the LMV2x/3x... system	Remedy
<b>87</b>	<b>#</b>	<b>Error air actuator</b>	
	0	Position error	Target position could not be reached within the required tolerance band → check to see if actuator is locked or overloaded
	Bit 0 Valency 1	Line interruption	Line interruption detected at actuator's terminals → check wiring (voltage X53 across pin 5 or 6 and pin 2 >0.5 V)
	Bit 3 Valency ≥ 8	Curve too steep in terms of ramp rate	The slope of the curve may be a maximum position change of 31° between 2 curvepoints in modulating mode
	Bit 4 Valency ≥ 16	Sectional deviation in comparison with last referencing	Actuator was overloaded or mechanically twisted. 1. Check to see if the actuator is blocked somewhere along its working range. 2. Check to see if the torque is sufficient for the application.
<b>90</b>	<b>#</b>	<b>Internal error basic unit</b>	
<b>91</b>	<b>#</b>	<b>Internal error basic unit</b>	
<b>93</b>	<b>#</b>	<b>Error flame signal acquisition</b>	
	3	Short-circuit of sensor	Short-circuit at QRB... 1. Check wiring. 2. Flame detector possibly fault.
<b>95</b>	<b>#</b>	<b>Error relay supervision</b>	
	3 Ignition transformer 4 Fuel valve 1 5 Fuel valve 2 6 Fuel valve 3	External power supply NO contact	Check wiring
<b>96</b>	<b>#</b>	<b>Error relay supervision</b>	
	3 Ignition transformer 4 Fuel valve 1 5 Fuel valve 2 6 Fuel valve 3	Relay contacts have welded	Test the contacts: 1. Unit connected to power: Fan output must be dead. 2. Disconnect power: Disconnect fan. No resistive connection between fan output and neutral conductor allowed. If one of the 2 tests fails, release the unit since contact have definitively welded and safety can no longer be ensured.
<b>97</b>	<b>#</b>	<b>Error relay supervision</b>	
	0	Safety relay contacts have welded or external power supply fed to safety relay	Test the contacts: 1. Unit connected to power: Fan output must be dead. 2. Disconnect power: Disconnect fan. No resistive connection between fan output and neutral conductor allowed. If one of the 2 tests fails, release the unit since contacts have definitively welded and safety can no longer be ensured.

Error code	Diagnostic code	Meaning for the LMV2x/3x... system	Remedy
98	#	<b>Error relay supervision</b>	
	2 Safety valve 3 Ignition transformer 4 Fuel valve 1 5 Fuel valve 2 6 Fuel valve 3	<i>Relay does not pull in</i>	Make a reset; if error occurs repeatedly, replace the unit
99	#	<b>Internal error relay control</b>	Make a reset; if error occurs repeatedly, replace the unit
	3	<i>Internal error relay control</i>	Make a reset. If error occurs repeatedly, replace the unit Software version V03.10: If error C:99 D:3 occurs during standardization of the VSD, deactivate temporarily function <i>Alarm in case of start prevention</i> (parameter number 210 = 0, when using a release contact) or <i>interrupt</i> the controller-ON signal
100	#	<b>Internal error relay control</b>	Make a reset; if error occurs repeatedly, replace the unit
105	#	<b>Internal error contact sampling</b>	
	0 Pressure switch-min 1 Pressure switch-max / POC 2 Fuel selection 0 / Reset 3 Air pressure 4 Load controller open 5 Load controller on / off 6 Load controller close 7 Safety loop / Burner flange 8 Safety valve 9 Ignition transformer 10 Fuel valve 1 11 Fuel valve 2 12 Fuel valve 3 13 Fuel selection 1 / Reset	<i>Stuck-At failure</i>	Can be caused by capacitive loads or supply of DC voltage to the mains voltage inputs. The diagnostic code indicates the input where the problem occurred
106	#	<b>Internal error contact request</b>	Make a reset; if error occurs repeatedly, replace the unit
107	#	<b>Internal error contact request</b>	Make a reset; if error occurs repeatedly, replace the unit
108	#	<b>Internal error contact request</b>	Make a reset; if error occurs repeatedly, replace the unit
110	#	<b>Internal error voltage monitor test</b>	Make a reset; if error occurs repeatedly, replace the unit
111	#	<b>Power failure</b>	Mains voltage to low Exchange ratio diagnostics code → voltage value (230 V: 1.683)
112	0	<i>Mains voltage recovery</i>	Error code for triggering a reset on power restoration (no error)
113	#	<b>Internal error mains voltage supervision</b>	Make a reset; if error occurs repeatedly, replace the unit
115	#	<b>Internal error system counter</b>	
116	0	<i>Designed life time exceeded (250'000 startups)</i>	Warning threshold has been reached. The unit should be replaced

Error code	Diagnostic code	Meaning for the LMV2x/3x... system	Remedy
117	0	<i>Life time exceeded Operation no longer allowed</i>	Switch-off threshold has been reached
120	0	<i>Interrupt limitation fuel meter input</i>	Too many disturbance pulses at the fuel meters input → Improve EMC
121	#	<b>Internal error EEPROM access</b>	Make a reset, repeat last parameterization / check. Restore the parameter set, if error occurs repeatedly, replace the unit
122	#	<b>Internal error EEPROM access</b>	Make a reset, repeat last parameterization / check. Restore the parameter set, if error occurs repeatedly, replace the unit
123	#	<b>Internal error EEPROM access</b>	Make a reset, repeat last parameterization / check. Restore the parameter set, if error occurs repeatedly, replace the unit
124	#	<b>Internal error EEPROM access</b>	Make a reset, repeat last parameterization / check. Restore the parameter set, if error occurs repeatedly, replace the unit
125	#	<b>Internal error EEPROM read access</b>	Make a reset, repeat last parameterization / check. If error occurs repeatedly, replace the unit
126	#	<b>Internal error EEPROM write access</b>	Make a reset, repeat last parameterization / check. If error occurs repeatedly, replace the unit
127	#	<b>Internal error EEPROM access</b>	Make a reset, repeat last parameterization / check. Restore the parameter set, if error occurs repeatedly, replace the unit
128	0	<i>Internal error EEPROM access - synchronization during initialization</i>	Make a reset; if error occurs repeatedly, replace the unit
129	#	<b>Internal error EEPROM access – command synchronization</b>	Make a reset, repeat last parameterization / check. If error occurs repeatedly, replace the unit
130	#	<b>Internal error EEPROM access - timeout</b>	Make a reset, repeat last parameterization / check. If error occurs repeatedly, replace the unit
131	#	<b>Internal error EEPROM access - page on abort</b>	Make a reset, repeat last parameterization / check. If error occurs repeatedly, replace the unit
132	#	<b>Internal error EEPROM register initialization</b>	Make a reset; if error occurs repeatedly, replace the unit
133	#	<b>Internal error EEPROM access – Request synchronization</b>	Make a reset, repeat last parameterization / check. If error occurs repeatedly, replace the unit
134	#	<b>Internal error EEPROM access – Request synchronization</b>	Make a reset, repeat last parameterization / check. If error occurs repeatedly, replace the unit
135	#	<b>Internal error EEPROM access – Request synchronization</b>	Make a reset, repeat last parameterization / check. If error occurs repeatedly, replace the unit
136	1	<i>Restore started</i>	Restore of a backup has been started (no error)

Error code	Diagnostic code	Meaning for the LMV2x/3x... system	Remedy
137	#	<b>Internal error – backup / restore</b>	
	157 (-99)	<i>Restore – ok, but backup &lt; data set of current system</i>	Restore successful, but backup data record is smaller than in the current system
	239 (-17)	<i>Backup – storage of backup in AZL2... faulty</i>	Reset and repeat backup
	240 (-16)	<i>Restore – no backup in AZL2...</i>	No backup stored in AZL2...
	241 (-15)	<i>Restore – abortion due to unsuitable product no. (ASN)</i>	Backup has an unsuitable product no. (ASN) and must not be restored
	242 (-14)	<i>Backup – backup made is inconsistent</i>	Backup is faulty and cannot be transferred back
	243 (-13)	<i>Backup – data comparison between <math>\mu</math>Cs faulty</i>	Reset and repeat backup
	244 (-12)	<i>Backup data are incompatible</i>	Backup data are incompatible with the current software version, restore not possible
	245 (-11)	<i>Access error to parameter Restore_Complete</i>	Reset and repeat backup
	246 (-10)	<i>Restore – timeout when storing in EEPROM</i>	Reset and repeat backup
	247 (-9)	<i>Data received are inconsistent</i>	Backup data record invalid, restore not possible
	248 (-8)	<i>Restore cannot at present be made</i>	Reset and repeat backup
	249 (-7)	<i>Restore – abortion due to unsuitable burner identification</i>	Backup has an unsuitable burner identification and must not be transferred to the unit
	250 (-6)	<i>Backup – CRC of one page is not correct</i>	Backup data record invalid, restore not possible
	251 (-5)	<i>Backup – burner identification is not defined</i>	Define burner identification and repeat backup
	252 (-4)	<i>After restore, pages still on ABORT</i>	Reset and repeat backup
	253 (-3)	<i>Restore cannot at present be made</i>	Reset and repeat backup
	254 (-2)	<i>Abortion due to transmission error</i>	Reset and repeat backup
	255 (-1)	<i>Abortion due to timeout during backup / restore</i>	Make a reset, check the connections and repeat backup / restore In case of repeated backup timeout, the AZL2... does not yet support backup functionality
146	#	<b>Timeout building automation interface</b>	Refer to Modbus User Documentation (A7541)
	1	<i>Modbus timeout</i>	
	2	<i>reserved</i>	

Error code	Diagnostic code	Meaning for the LMV2x/3x... system	Remedy
150	#	<b>TÜV test</b>	
	1 (-1)	<i>Invalid phase</i>	TÜV test may only be started in phase 60 (operation)
	2 (-2)	<i>TÜV test default output too low</i>	TÜV test default output must not be smaller than the lower output limit
	3 (-3)	<i>TÜV test default output too high</i>	TÜV test default output must not be greater than the upper output limit
	4 (-4)	<i>Manual interruption</i>	No error: Manual abortion of TÜV test by user
	5 (-5)	<i>TÜV test timeout</i>	No loss of flame after shutdown of fuel valves 1. Check to see if there is extraneous light 2. Check wiring to see if there is a short-circuit 3. Check to see if valve is leaking
165	#	<b>Internal error</b>	
166	0	<i>Internal error watchdog reset</i>	
167	#	<b>Manual locking</b>	Unit has been manually locked (no error)
	1	<i>Manual locking by contact</i>	
	2	<i>Manual locking by AZL2...</i>	
	3	<i>Manual locking by PC tool</i>	
	8	<i>Manual locking by the AZL2... Timeout / communication breakdown</i>	During a curve adjustment via the AZL2..., the timeout for menu operation has elapsed (setting via parameter 127), or communication between the LMV26... and the AZL2... has broken down
	9	<i>Manual locking by the PC tool Communication breakdown</i>	During a curve adjustment via the ACS410, communication between the LMV26... and the ACS410 was interrupted for more than 30 seconds
	33	<i>Manual locking by the PC tool Test of lockout</i>	PC tool made a reset attempt with an error-free system
168	#	<b>Internal error management</b>	Make a reset; if error occurs repeatedly, replace the unit
169	#	<b>Internal error management</b>	Make a reset; if error occurs repeatedly, replace the unit
170	#	<b>Internal error management</b>	Make a reset; if error occurs repeatedly, replace the unit
171	#	<b>Internal error management</b>	Make a reset; if error occurs repeatedly, replace the unit
200 OFF	#	<b>System error-free</b>	No error

Error code	Diagnostic code	Meaning for the LMV2x/3x... system	Remedy
201 OFF UPr0 or OFF UPr1	#	<b>Prevention of startup</b>	Start prevention due to unparameterized unit Go to error history, entry 702, for initial cause of the error with shutdown in connection with the first curve settings
	Bit 0 Valency 1	No operating mode selected	
	Bit 1 Valency 2..3	No fuel train defined	
	Bit 2 Valency 4..7	No curves defined	
	Bit 3 Valency 8..15	Standardized speed undefined	
	Bit 4 Valency 16..31	Backup / restore was not possible	
202	#	<b>Internal error operating mode selection</b>	Redefine the operating mode (parameter 201)
203	#	<b>Internal error</b>	Redefine the operating mode (parameter 201). Make a reset; if error occurs repeatedly, replace the unit
204	Phase number	<b>Program stop</b>	Program stop is active (no error)
205	#	<b>Internal error</b>	Make a reset; if error occurs repeatedly, replace the unit
206	0	Inadmissible combination of units (basic unit – AZL2...)	
207	#	<b>Version compatibility basic unit – AZL2...</b>	
	0	Basic unit version too old	
	1	AZL2... version too old	
208	#	<b>Internal error</b>	Make a reset; if error occurs repeatedly, replace the unit
209	#	<b>Internal error</b>	Make a reset; if error occurs repeatedly, replace the unit
210	0	Selected operating mode is not released for the basic unit	Select a released operating mode for the basic unit
240	#	<b>Internal error</b>	Make a reset; if error occurs repeatedly, replace the unit
245	#	<b>Internal error</b>	Make a reset; if error occurs repeatedly, replace the unit
250	#	<b>Internal error</b>	Make a reset; if error occurs repeatedly, replace the unit



## Wiring variants for LMV27

### ConnectorX75

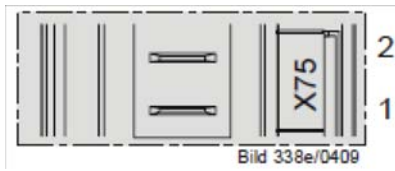

2 - Fuel meter input

1 - Supply fuel meter

### ConnectorX5-02

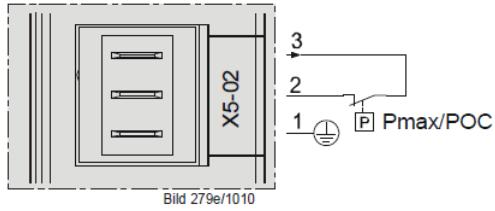

ConnectionsPmax

## Wiring variants for LMV26

### Connector X08-04 / X09-04

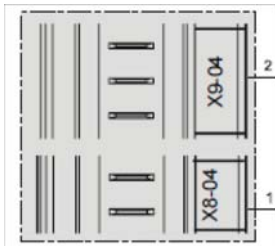

2 - Fuel 0

1 - Fuel1

### Connector X75



2 - Fuel meter input

1 - Supply fuel meter

### Connector X64

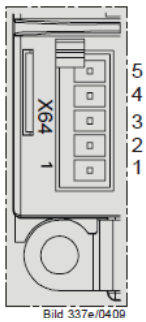

5 -Power supply speed sensor

4 -Speed sensor input

3 - PWM (Pulse Width Modulation) speed output

2 - GND (signal reference)

1 -Controller input (4÷20mA)

### Connector X74

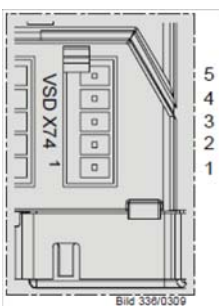

5 -Supply

4 -Feedback signal

3 - PWM (Pulse Width Modulation) speed output

2 - GND (signal reference)

1 -External supply 24V DC

## Wiring variants for LMV37

### Connector X75



- 2 - Fuel meter input
- 1 - Supply fuel meter

### Connector X5-02

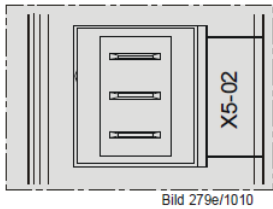

- 3
  - 2
  - 1
- Connections Pmax  
Pmax/POC

### Connector X64

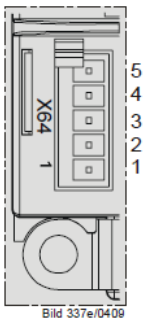

- 5 - Power supply speed sensor
- 4 - Speed sensor input
- 3 - PWM (Pulse Width Modulation) speed output
- 2 - GND (signal reference)
- 1 - Controller input (4÷20mA)

### Connector X74

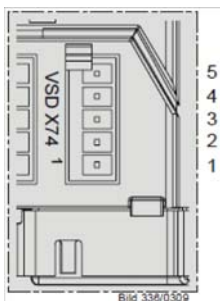

- 5 - Supply
- 4 - Feedback signal
- 3 - PWM (Pulse Width Modulation) speed output
- 2 - GND (signal reference)
- 1 - External supply 24V DC









C.I.B. UNIGAS S.p.A.  
Via L.Galvani, 9 - 35011 Campodarsego (PD) - ITALY  
Tel. +39 049 9200944 - Fax +39 049 9200945/9201269  
web site: [www.cibunigas.it](http://www.cibunigas.it) - e-mail: [cibunigas@cibunigas.it](mailto:cibunigas@cibunigas.it)

*Note: Specifications and data subject to change. Errors and omissions excepted.*



## USER'S MANUAL

COD. M12925CA Rel 1.2 08/2014

SOFTWARE VERSION 1.0x T73  
code 80379 / Edition 01 - 06/2012



## 1 • INSTALLATION

### • Dimensions and cut-out; panel mounting

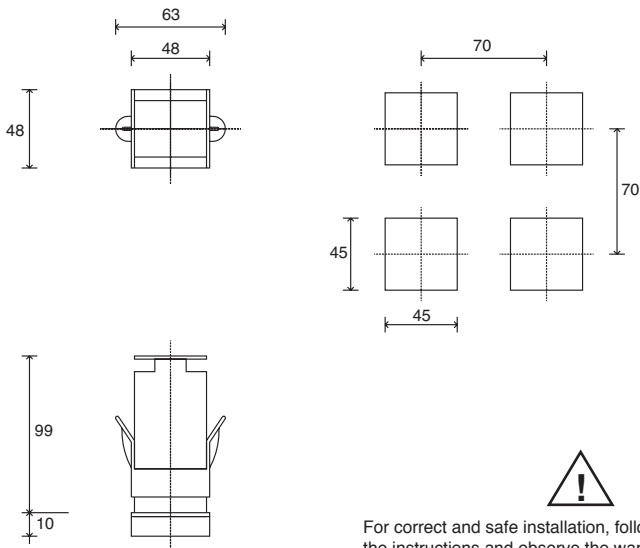

For correct and safe installation, follow the instructions and observe the warnings contained in this manual.

#### Panel mounting:

To fix the unit, insert the brackets provided into the seats on either side of the case. To mount two or more units side by side, respect the cut-out dimensions shown in the drawing.

**CE MARKING:** The instrument conforms to the European Directives 2004/108/CE and 2006/95/CE with reference to the generic standards: **EN 61000-6-2** (immunity in industrial environment) **EN 61000-6-3** (emission in residential environment) **EN 61010-1** (safety).

**MAINTENANCE:** Repairs must be done only by trained and specialized personnel.

Cut power to the device before accessing internal parts.

Do not clean the case with hydrocarbon-based solvents (Petrol, Trichlorethylene, etc.). Use of these solvents can reduce the mechanical reliability of the device. Use a cloth dampened in ethyl alcohol or water to clean the external plastic case.

**SERVICE:** GEFRA has a service department. The warranty excludes defects caused by any use not conforming to these instructions.

EMC conformity has been tested with the following connections

FUNCTION	CABLE TYPE	LENGTH
Power supply cable	1 mm <sup>2</sup>	1 m
Relay output cable	1 mm <sup>2</sup>	3,5 m
TC input	0,8 mm <sup>2</sup> compensated	5 m
Pt100 input	1 mm <sup>2</sup>	3 m

## 2 • TECHNICAL SPECIFICATIONS

Display	2x4 digit green, high display 10 and 7mm
Keys	4 of mechanical type (Man/Aut, INC, DEC, F)
Accuracy	0.2% f.s. ±1 digit ambient temperature 25°C
Main input (settable digital filter)	TC, RTD, PTC, NTC 60mV, 1V Ri≥1MΩ; 5V, 10V Ri≥10KΩ; 20mA Ri=50Ω Tempo di campionamento 120 msec.
Type TC Thermocouples (ITS90)	Type TC Thermocouples : J,K,R,S,T (IEC 584-1, CEI EN 60584-1, 60584-2) ; custom linearization is available / types B,E,N,L GOST,U,G,D,C are available by using the custom linearization.
Cold junction error	0,1° / °C
RTD type (scale configurable within indicated range, with or without decimal point) (ITS90) Max line resistance for RTD	DIN 43760 (Pt100), JPT100 20Ω
PTC type / NTC Type	990Ω, 25°C / 1KΩ, 25°C
Safety	detection of short-circuit or opening of probes, LBA alarm
°C / °F selection	configurable from faceplate
Linear scale ranges	-1999 to 9999 with configurable decimal point position
Controls	PID, Self-tuning, on-off
pb - dt - it	0,0...999,9 % - 0,00...99,99 min - 0,00...99,99 min
Action	Heat / Cool
Control outputs	on / off
Maximum power limit heat / cool	0,0...100,0 %
Cycle time	0...200 sec
Main output type	relay, logic, continuous (0...10V Rload ≥ 250KΩ, 0/4...20mA Rload ≤ 500Ω)
Softstart	0,0...500,0 min
Fault power setting	-100,0...100,0 %
Automatic blanking	Displays PV value, optional exclusion
Configurable alarms	Up to 3 alarm functions assignable to an output, configurable as: maximum, minimum, symmetrical, absolute/deviation, LBA
Alarm masking	- exclusion during warm up - latching reset from faceplate or external contact
Type of relay contact	NO (NC), 5A, 250V/30Vdc cosφ=1
Logic output for static relays	24V ±10% (10V min at 20mA)
Transmitter power supply	15/24Vdc, max 30mA short-circuit protection
Power supply (switching type)	(std) 100 ... 240Vac ±10% (opt.) 11...27Vac/dc ±10%; 50/60Hz, 8VA max
Faceplate protection	IP65
Working / Storage temperature range	0...50°C / -20...70°C
Relative humidity	20 ... 85% non-condensing
Environmental conditions of use	for internal use only, altitude up to 2000m
Installation	Panel, plug-in from front
Weight	160g for the complete version

### 3 · DESCRIPTION OF FACEPLATE

**Function indicators**  
Indicates modes of operation

L1 MAN/AUTO = OFF (automatic control)  
ON (manual control)

L2 PRE-HEATING = ON (running)

L3 SELFTUNING = ON (enabled Self)  
OFF (disabled Self)

**Automatic/Manual adjustment selection**  
Active only when PV display visualises the process variable (button pressed for at least 5 sec.)

**"Inc" and "Dec" key**  
Press to increment (decrement) any numerical parameter •• Increment (decrement) speed is proportional to time key stays pressed •• The operation is not cyclic: once the maximum (minimum) value of a field is reached, the value will not change even if the key remains pressed.

**Indication of output states**  
OUT 1 (AL1); OUT 2 (OPEN); OUT 3 (CLOSED)

**PV Display:** Indication of process variable  
Error Indication: LO, HI, Sbr, Err  
**LO**= the value of process variable is < di LO\_S  
**HI**= the value of process variable is > di HI\_S  
**Sbr**= faulty sensor or input values higher than max. limits  
**Err**= PT100 third wire opened for PT100, PTC or input values lower than min. limits (i.e.: TC wrong connection)

**SV display:** Indication of setpoint

**Function key**  
Gives access to the various configuration phases •• Confirms change of set parameters and browses next or previous parameter (if Auto/Man key is pressed)

### 4 · CONNECTIONS

**• Outputs**

Out2 (19) - 5A at 250Vac/30Vdc relay

Out1 (21) - 5A/250Vac relay

Out3 (5) - 5A at 250Vac/30Vdc relay

TOP

**• Inputs**

**• TC Input**

Available thermocouples:  
J, K, R, S, T  
(B, E, N, L, U, G, D, C custom linearization is available)

- Observe polarities
- For extensions, use the correct compensating cable for the type of TC used

**• Power Supply**

Standard:  
100...240Vac ± 10%

Optional:  
11...27Vac/Vdc ± 10%

Max. power 8VA; 50/60 Hz

**• Linear input (I)**

Linear input in dc current  
20mA, Ri = 50Ω

**• Input 1 linear with transmitter 2 wires**

**• Identification of boards**

Power board - Solder side

Select transmitter voltage

**N.B. :** you can keep the **OUT1** relay energized at power-up by inserting jumper **S2** and removing resistance **R20**.

CPU board - Component side

IN/OUT boards (see appendix)

Select signal at contact 3

**• Linear input (V)**

Linear input in dc voltage  
60mV, 1V  
Ri > 1MΩ  
5V, 10V  
Ri > 10KΩ

**• Pt100 / PTC / NTC**

Use wires of adequate diameter (min. 1mm²)  
PT100, JPT100, PTC, NTC

**• Device structure**

# 5 • “EASY” PROGRAMMING and CONFIGURATION

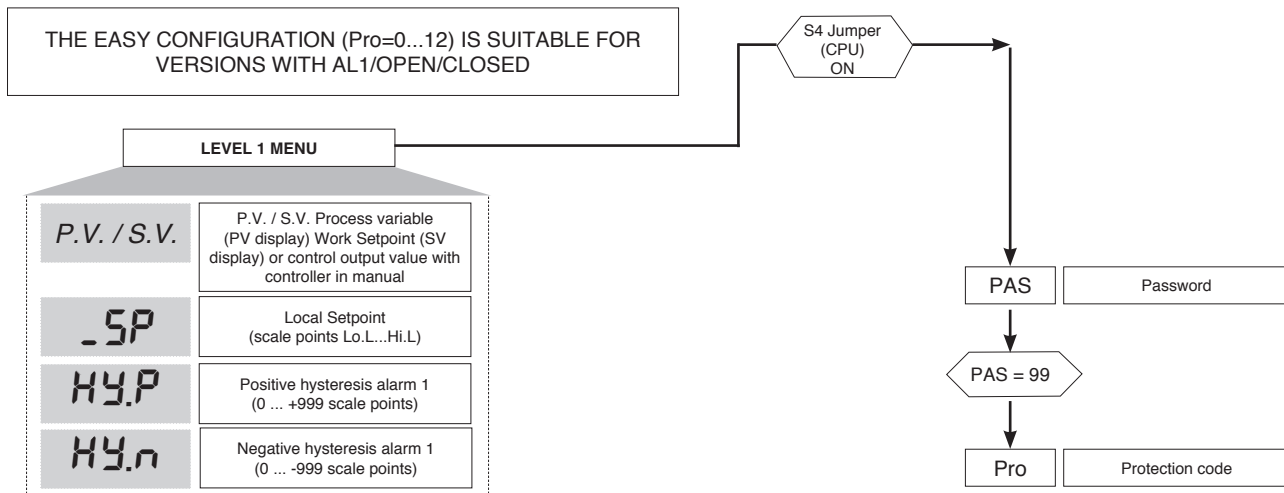

## • Prot

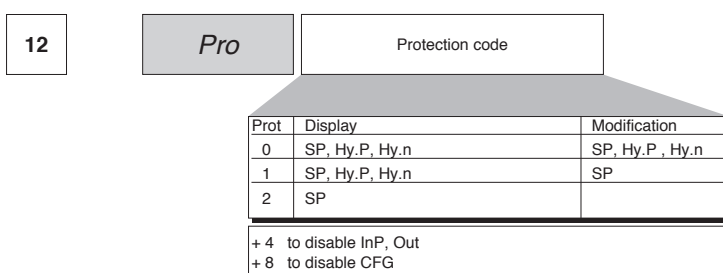

# 6 • PROGRAMMING and CONFIGURATION

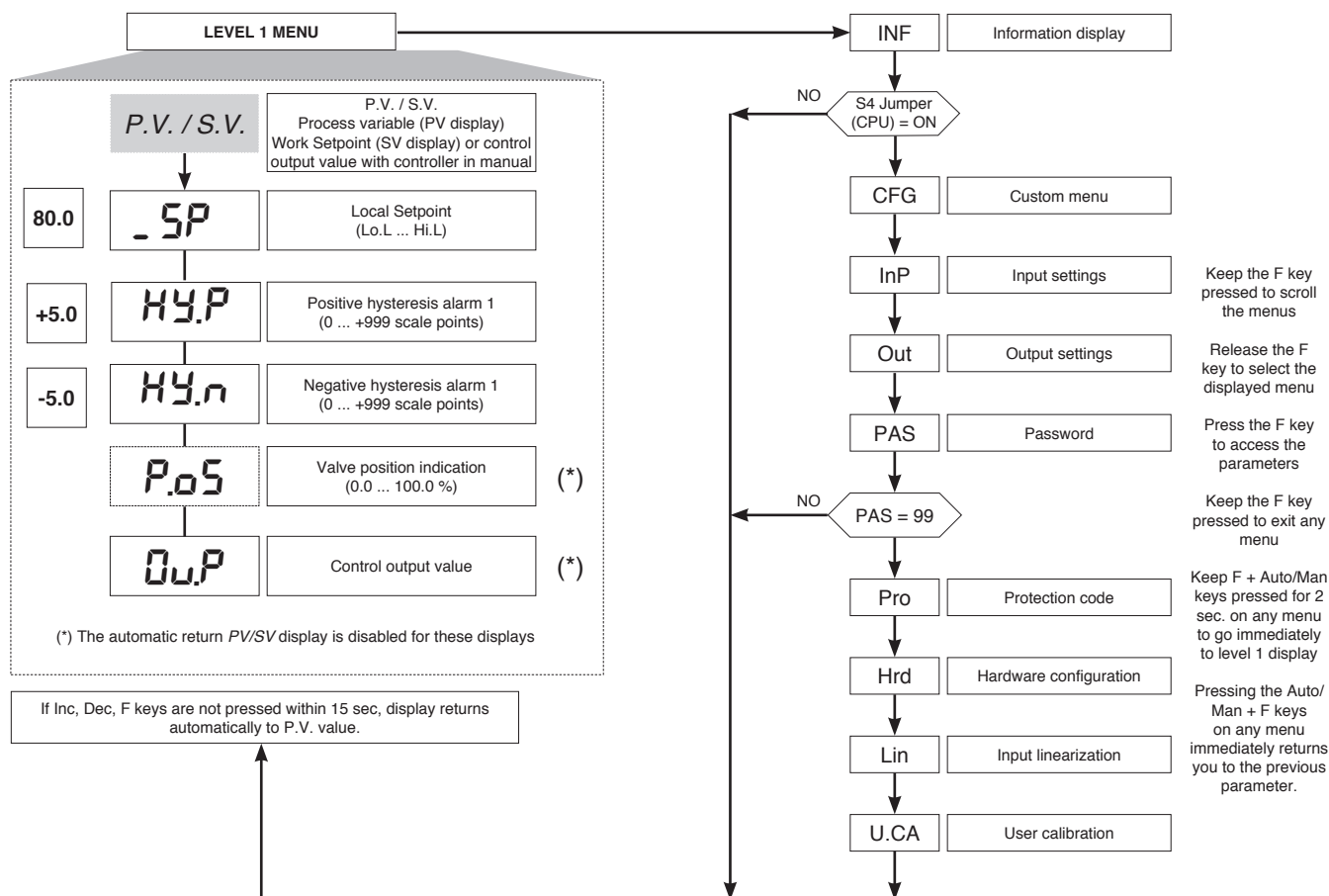

**N.B.:** Once a particular configuration is entered, all unnecessary parameters are no longer displayed

## • InFo Display

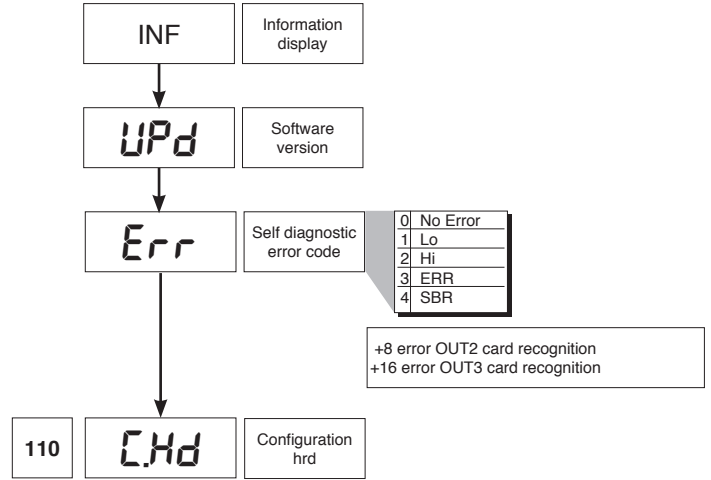
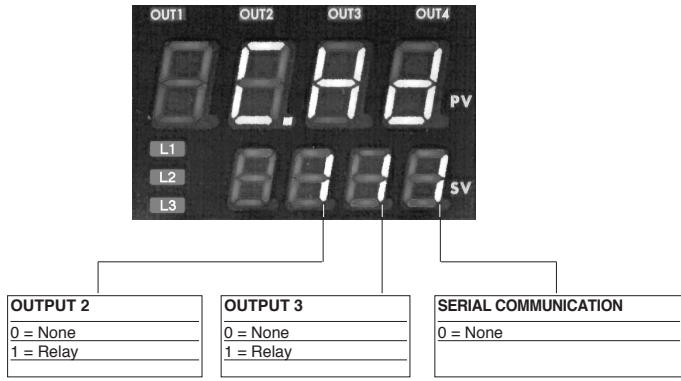

## • CFG

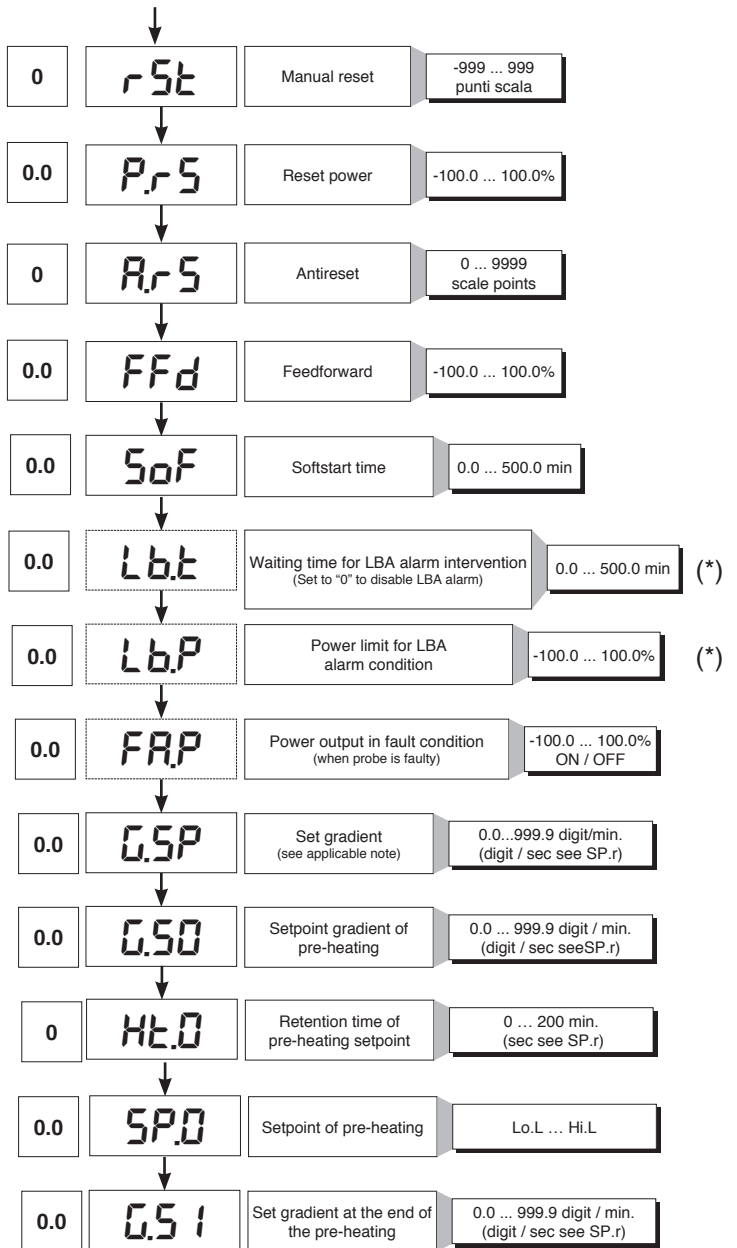
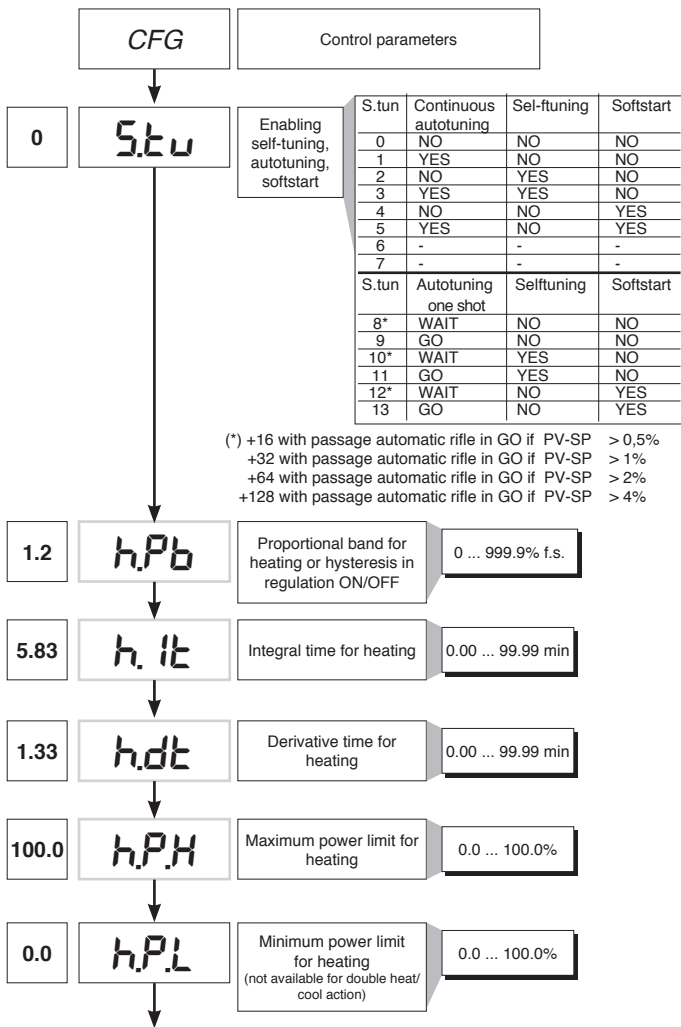

(\*) LBA alarm may be reset by simultaneously pressing  $\Delta$  +  $\nabla$  keys when OutP is displayed or by switching to Manual.

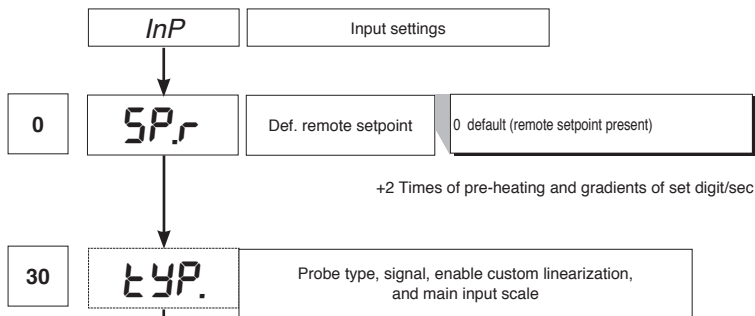

Type	Probe type	without decimal point	with decimal point
Sensore:			
TC			
0	TC J °C	0/1000	0.0/999.9
1	TC J °F	32/1832	32.0/999.9
2	TC K °C	0/1300	0.0/999.9
3	TC K °F	32/2372	32.0/999.9
4	TC R °C	0/1750	0.0/999.9
5	TC R °F	32/3182	32.0/999.9
6	TC S °C	0/1750	0.0/999.9
7	TC S °F	32/3182	32.0/999.9
8	TC T °C	-200/400	-199.9/400.0
9	TC T °F	-328/752	-199.9/752.0
28	TC	CUSTOM	CUSTOM
29	TC	CUSTOM	CUSTOM
30	PT100 °C	-200/850	-199.9/850.0
31	PT100 °F	-328/156.2	-199.9/999.9
32	JPT100 °C	-200/600	-199.9/600.0
33	JPT100 °F	-328/1112	-199.9/999.9
34	PTC °C	-55/120	-55.0/120.0
35	PTC °F	-67/248	-67.0/248.0
36	NTC °C	-10/70	-10.0/70.0
37	NTC °F	14/158	14.0/158.0
38	0...60 mV	-1999/9999	-199.9/999.9
39	0...60 mV	Custom scale	Custom scale
40	12...60 mV	-1999/9999	-199.9/999.9
41	12...60 mV	Custom scale	Custom scale
42	0...20 mA	-1999/9999	-199.9/999.9
43	0...20 mA	Custom scale	Custom scale
44	4...20 mA	-1999/9999	-199.9/999.9
45	4...20 mA	Custom scale	Custom scale
46	0...10 V	-1999/9999	-199.9/999.9
47	0...10 V	Custom scale	Custom scale
48	2...10 V	-1999/9999	-199.9/999.9
49	2...10 V	Custom scale	Custom scale
50	0...5 V	-1999/9999	-199.9/999.9
51	0...5 V	Custom scale	Custom scale
52	1...5 V	-1999/9999	-199.9/999.9
53	1...5 V	Custom scale	Custom scale
54	0...1 V	-1999/9999	-199.9/999.9
55	0...1 V	Custom scale	Custom scale
56	200mv...1V	-1999/9999	-199.9/999.9
57	200mv...1V	Custom scale	Custom scale
58	Cust10 V-20mA	-1999/9999	-199.9/999.9
59	Cust10 V-20mA	Custom scale	Custom scale
60	Cust 60mV	-1999/9999	-199.9/999.9
61	Cust 60mV	Custom scale	Custom scale
62	PT100-JPT	CUSTOM	CUSTOM
63	PTC	CUSTOM	CUSTOM
64	NTC	CUSTOM	CUSTOM

For custom linearization:  
 - LO signal is generated with variable below Lo.S or at minimum calibration value  
 - HI signal is generated with variable above Lo.S or at maximum calibration value

Max. non-linearity error for thermocouples (TC), resistors (PT100) and thermistors (PTC, NTC).  
 The error is calculated as deviation from theoretical value and is expressed as percentage of full scale (in °C).

**S, R** range 0...1750°C; error < 0.2% f.s. (t > 300°C) / for other range; error < 0.5% f.s.  
**T** error < 0.2% f.s. (t > -150°C)  
**B** range 44...1800°C; error < 0.5% f.s. (t > 300°C) / range 44.0...999.9; error < 1% f.s. (t > 300°C)  
**U** range -99.9...99.9 and -99...99°C; error < 0.5% f.s. / for other range; error < 0.2% f.s. (t > -150°C)  
**G** error < 0.2% f.s. (t > 300°C)  
**D** error < 0.2% f.s. (t > 200°C)  
**C** range 0...2300; error < 0.2% f.s. / for other range; error < 0.5% f.s.

**NTC error < 0.5% f.s.**

Tc: J, K, E, N, L error < 0,2% f.s.  
 JPT100 and PTC error < 0,2% f.s.  
 PT100 scale -200...850°C  
 Precision better than 0,2% f.s. at 25°C  
 In range 0...50°C:  
 • Precision better than 0,2% f.s. in range -200...400°C  
 • Precision better than 0,4% f.s. in range +400...850°C (where f.s. refers to range -200... +850°C)

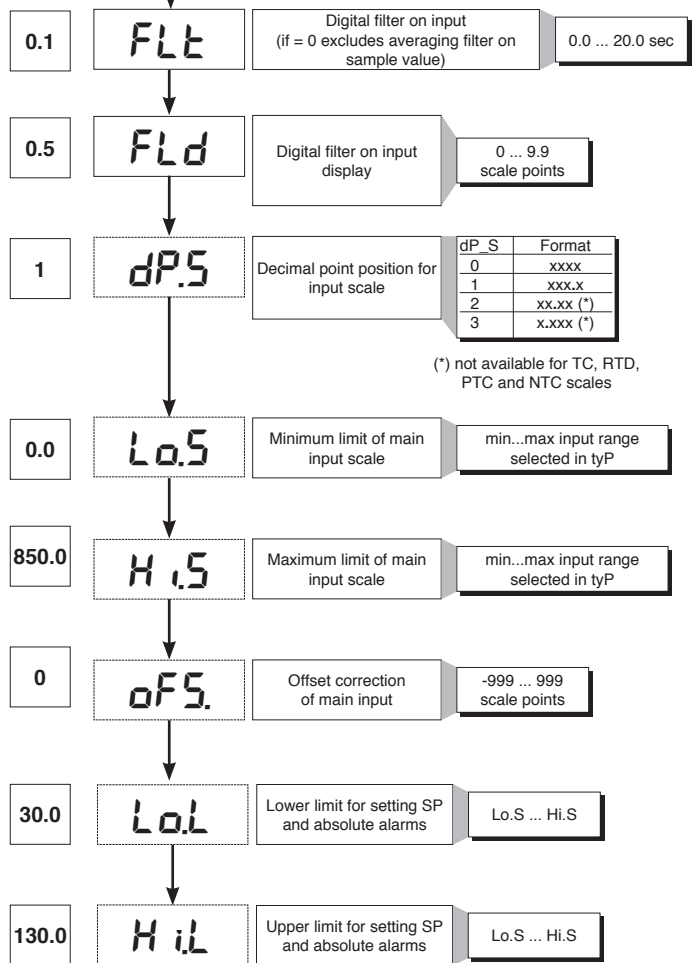

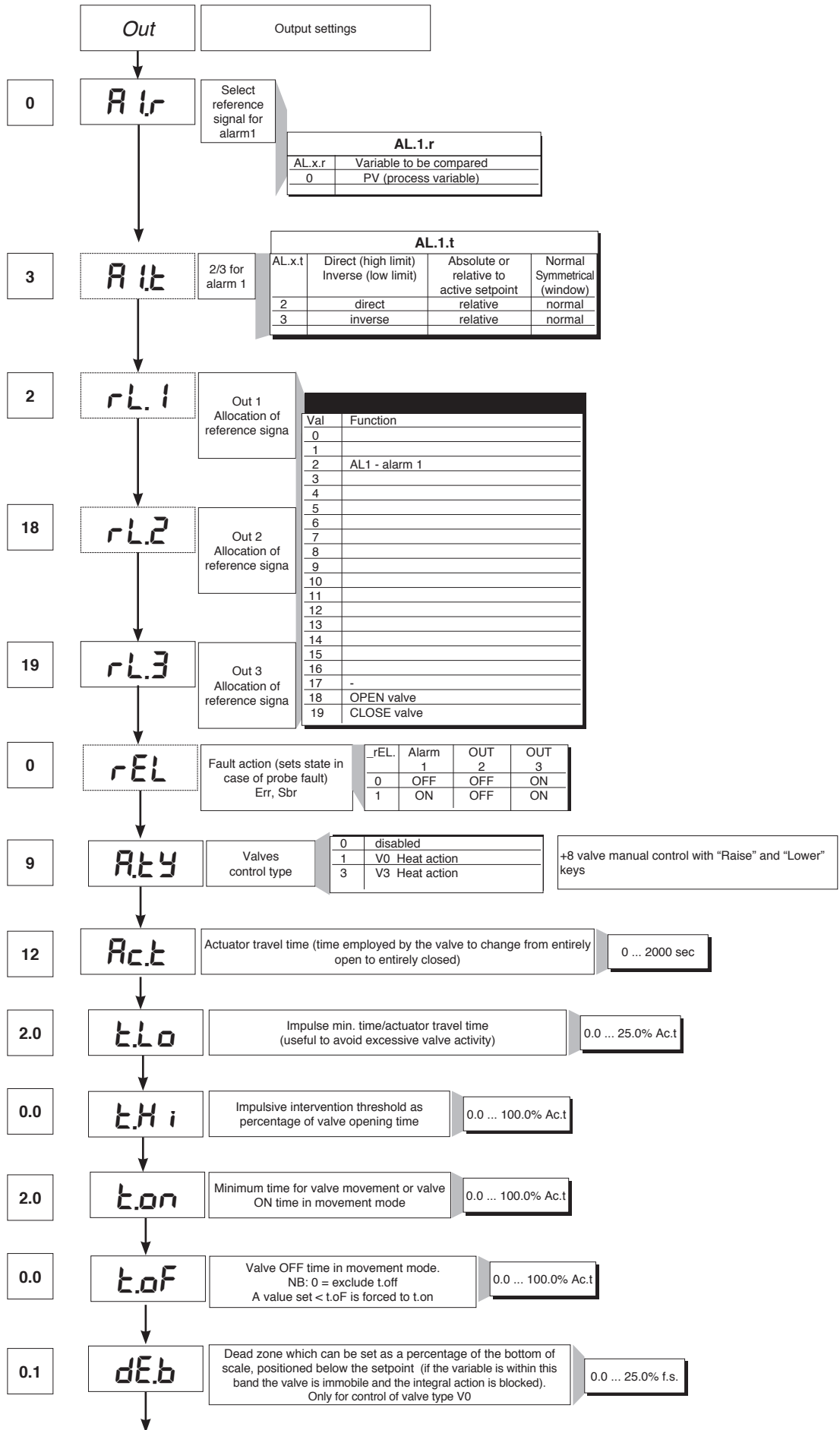

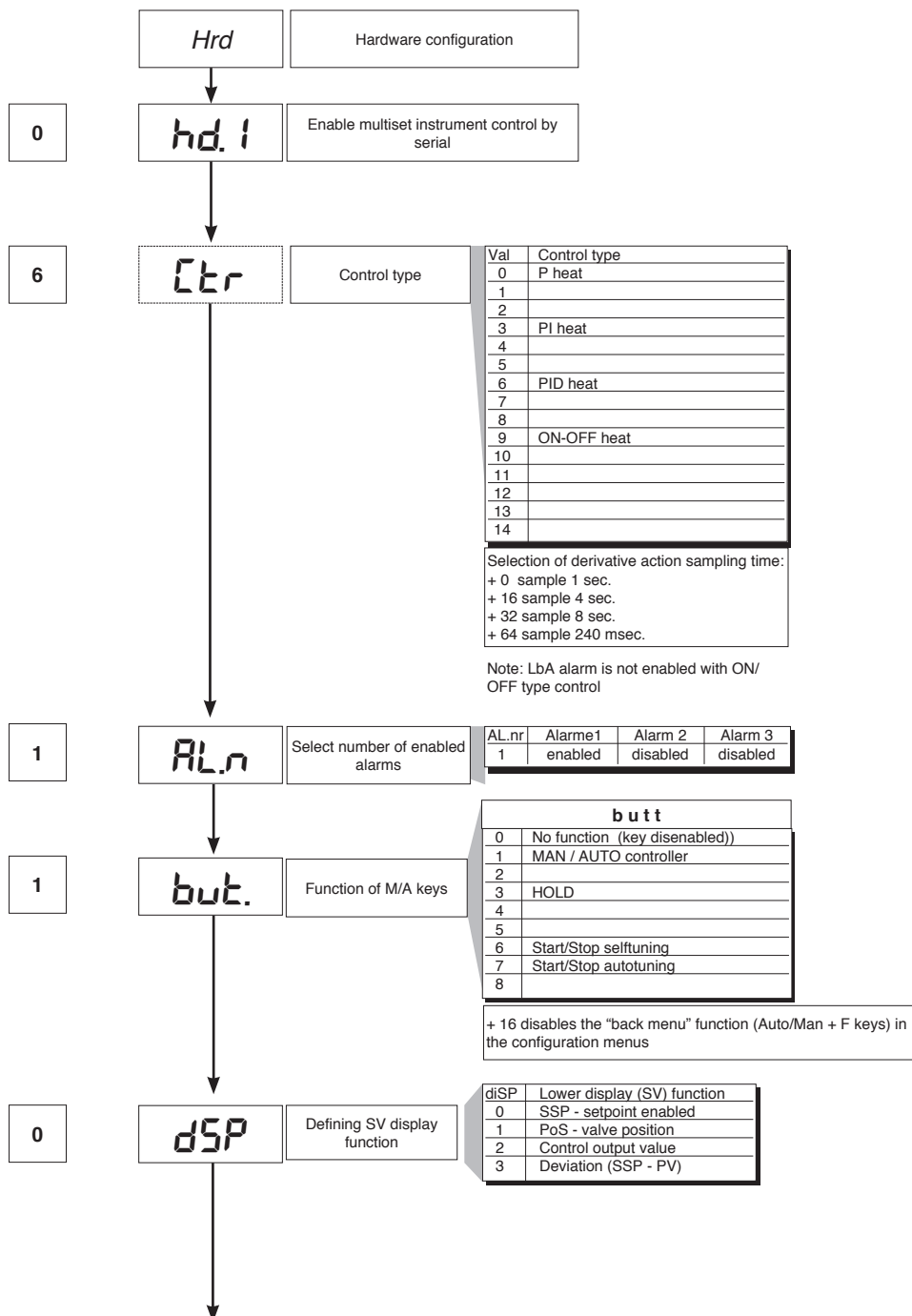
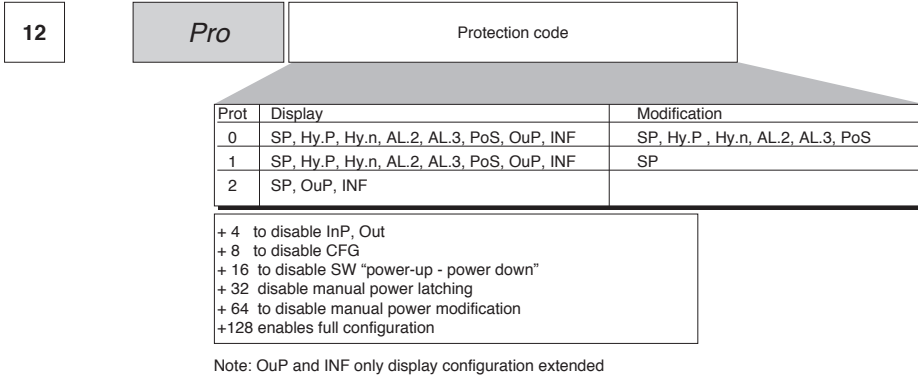

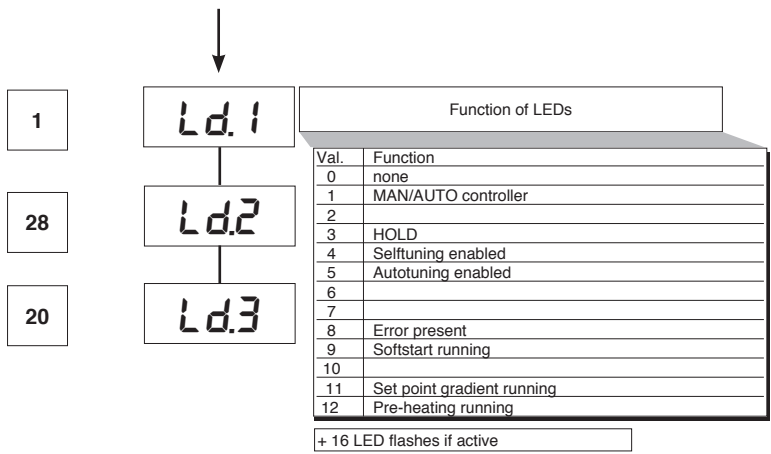

• Lin

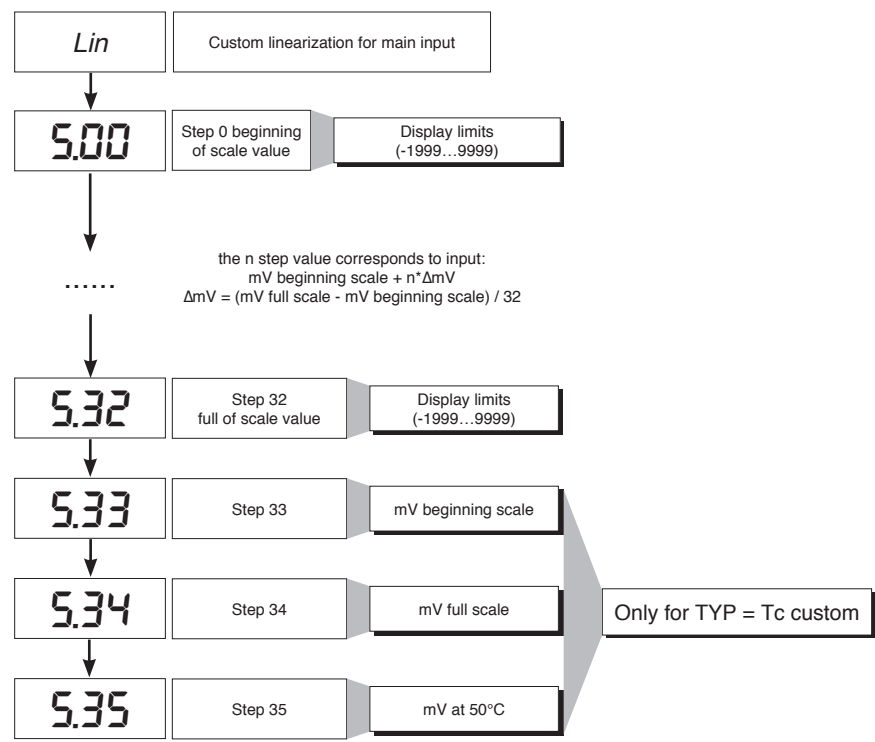

• U.CAL

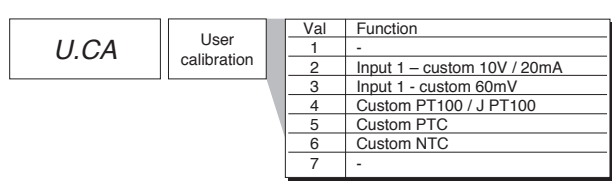

## 7 · CONSENT FOR BURNER AL1

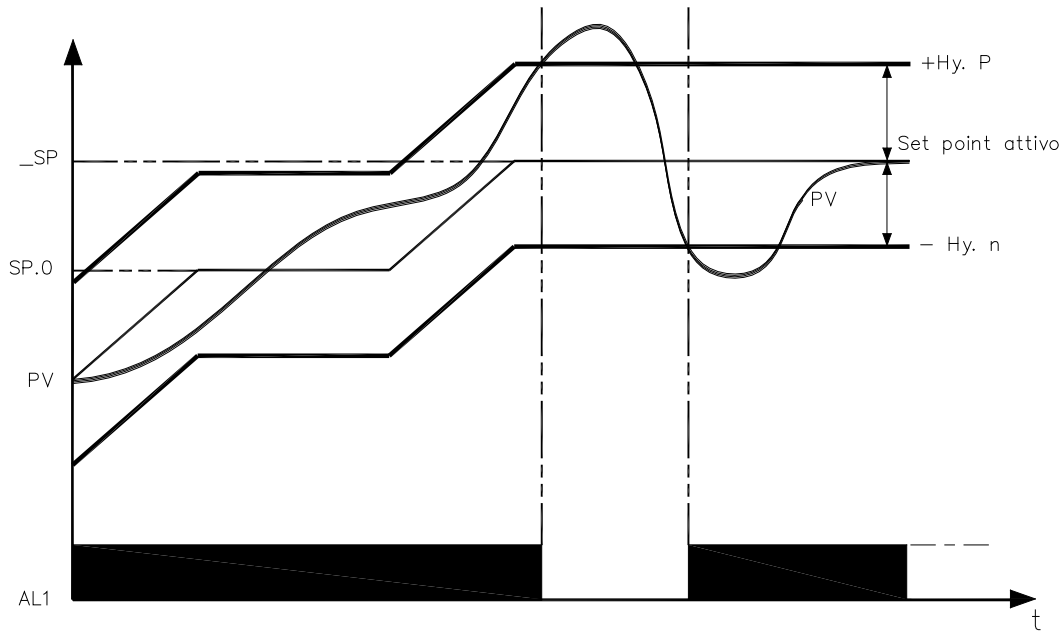

Obtain burner consent by configuring alarm 1 as inverse deviation with positive hysteresis Hy.P and negative hysteresis Hy.n

## 8 · PRE-HEATING FUNCTION

Enable the pre-heating function by setting parameters GS.0, Ht.0, GS.1 other than zero.

It consists of three phases that are activated sequentially at firing:

**- Ramp 0 phase**

Enabled by setting  $GS.0 > 0$ . Starting from setpoint = PV (initial state), it reaches pre-heating set SP.0 with gradient GS.0

**- Maintenance phase**

Enabled by setting  $Ht.0 > 0$ . Maintains pre-heating setpoint SP.0 for time Ht.0

**- Ramp 1 phase**

Enabled by setting  $GS.1 > 0$ . Starting from pre-heating setpoint SP.0, it reaches active  $\_SP$  set with gradient GS.1

In case of selftuning, the pre-heating function is not activated

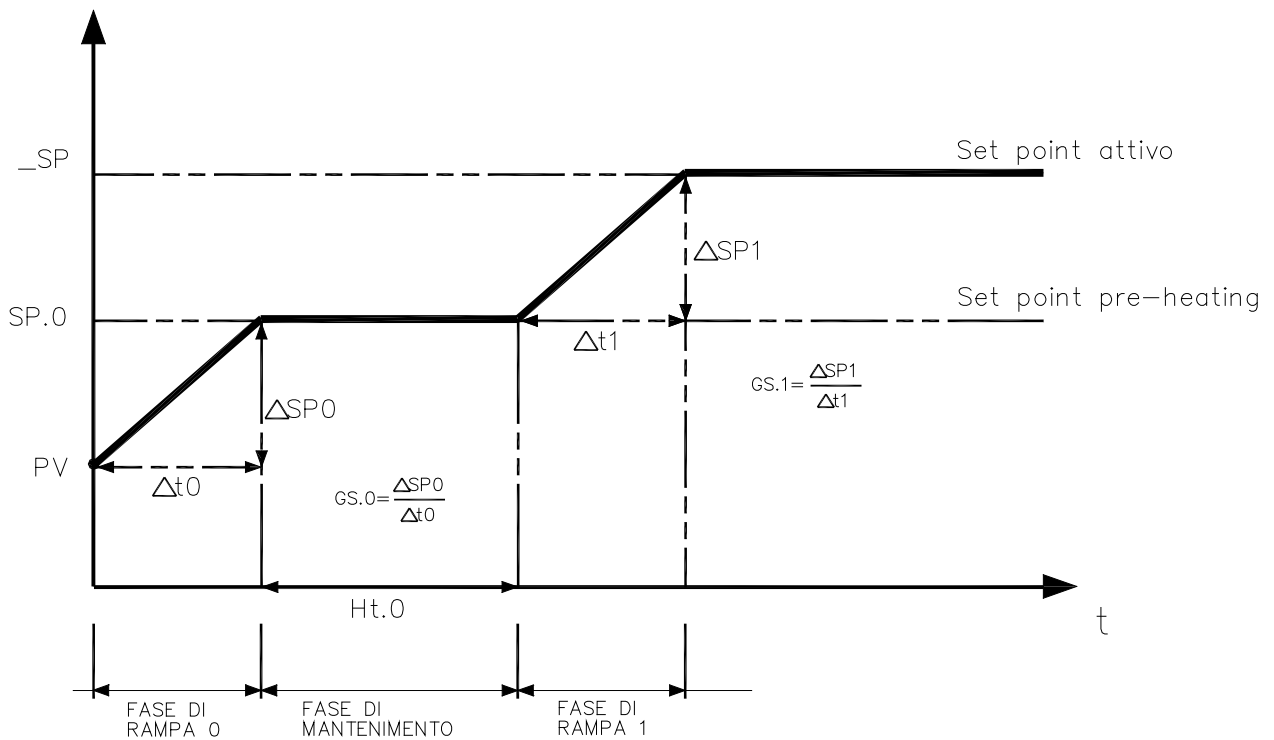

## 9 • ADJUSTMENT WITH MOTORIZED VALVE

In an adjustment process the adjustment valve has the function of varying fuel delivery (frequently corresponding to the thermal energy introduced into the process) in relation to the signal coming from the controller.

For this purpose it is provided with an actuator able to modify its opening value, overcoming the resistances produced by the fluid passing inside it.

The adjustment valves vary the delivery in a modulated manner, producing finite variations in the fluid passage inner area corresponding to finite variations of the actuator input signal, coming from the controller. The servomechanism, for example, comprises an electric motor, a reducer and a mechanical transmission system which actions the valve.

Various auxiliary components can be present such as the mechanical and electrical safety end travels, manual actioning systems.

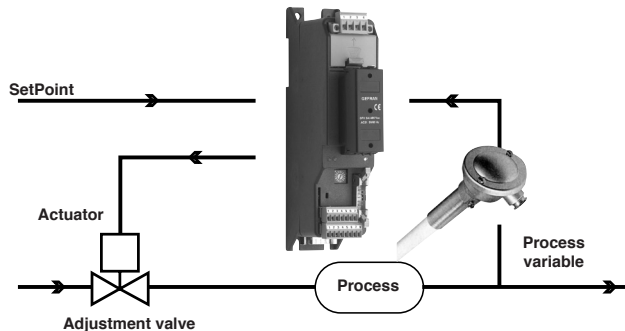

CONTROL EXAMPLE FOR V0 VALVE

The controller determines, on the basis of the dynamics of the process, the control output for the valve corresponding to the opening of the same in such a way so as to maintain the desired value of the process variable.

### Characteristic parameters for valves control

- Actuator time ( $A_c.t$ ) is the time employed by the valve to pass from entirely open to entirely closed (or vice-versa), and can be set with a resolution of one second. It is a mechanical feature of the valve+actuator unit.

**NOTE:** if the actuator's travel is mechanically limited it is necessary to proportionally reduce the  $A_c.t$  value.

- Minimum impulse ( $t.Lo$ ) expressed as a % of the actuator time (resolution 0.1%).

Represents the minimum change in position corresponding to a minimum change in power supplied by the instrument below which the actuator will not physically respond to the command.

This represents the minimum variation in position due to which the actuator does not physically respond to the command.

The minimum duration of the movement can be set in  $t.Lo$ , expressed as a % of actuator time.

- Impulsive intervention threshold ( $t.Hi$ ) expressed as a % of the actuator time (resolution 0.1%) represents the position displacement (requested position – real position) due to which the manoeuvre request becomes impulsive.

You can choose between 2 types of control:

1) ON time of movement =  $t.on$  and OFF time proportional to shift and greater than or equal to  $t.Lo$  (we recommend setting  $t.on = t.Lo$ ) (set  $t.oF = 0$ ).

2) ON time of movement =  $t.on$  and OFF time =  $t.oF$ . A value set for  $t.oF < t.on$  is forced to  $t.on$ . To activate this type, set  $t.oF >> 0$ .

The type of movement approach allows fine control of the reverse drive valve (from potentiometer or not), especially useful in cases of high mechanical inertia. Set  $t.Hi = 0$  to exclude modulation in positioning.

This type of modulated approach allows precise control of the feedback actioned valve, by a potentiometer or not, and is especially useful in cases of high mechanical inertia. Setting  $t.Hi = 0$  excludes modulation in positioning.

- Dead zone ( $dE.b$ ) is a displacement band between the adjustment setpoint and the process variable within which the controller does not supply any command to the valve (Open = OFF; Close = OFF). It is expressed as a percentage of the bottom scale and is positioned below the setpoint.

The dead zone is useful in an operative process to avoid straining the actuator with repeated commands and an insignificant effect on the adjustment. Setting  $dE.b = 0$  the dead zone is excluded.

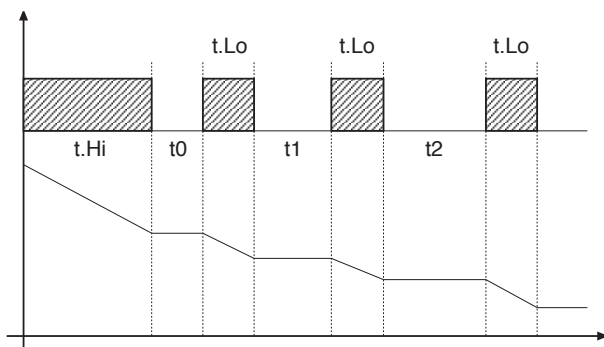

Graph of behavior inside the band with integral time  $\neq 0$ .

With integral time = 0, movement ON time is always equal to OFF time.

$t_0 = t.Lo$

## Valve control modes

With the controller in manual, the setting of parameter At.y  $\geq 8$  allows direct control of the valve open and close commands through the keyboard Increments and Decrements on the front seats.

**V0** - for floating valve without potentiometer

Model V0 have similar behaviour: every manoeuvre request greater than the minimum impulse t.Lo is sent to the actuator by means of the OPEN/CLOSE relays; every action updates the presumed position of the virtual potentiometer calculated on the basis of the actuator travel declared time.

In this way there is always a presumed position of the valve which is compared with the position request of the controller.

Having reached a presumed extreme position (entirely open or entirely closed determined by the "virtual potentiometer") the controller provides a command in the same direction, in this way ensuring the real extreme position is reached (minimum command time = t.on).

The actuators are usually protected against the OPEN command in the entirely open position or CLOSE command in the entirely closed position.

**V3** - for floating valve, PI control

When the difference between the position calculated by the controller and the only proportional component exceeds the value corresponding to the minimum impulse t.Lo the controller provides an OPEN or CLOSE command of the duration of the minimum impulse itself t.Lo.

At each delivery the integral component of the command is set to zero (discharge of the integral).

The frequency and duration of the impulses is correlated to the integral time (h.it or c.it).

*Non-movement behavior*

t.Hi = 0: with power = 100% or 0.0%, the corresponding open or close outputs always remain enabled (safety status).

*Movement behavior*

t.Hi  $\neq$  0: with position attained corresponding to 100% or 0.0%, the corresponding open or close outputs are switched off.

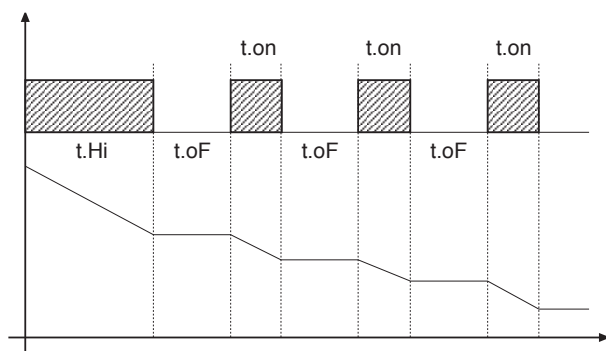

If t.oF = 0, current function is maintained.

If t.oF  $\neq$  0 movement mode will be as shown on the graph

## 10 • CONTROL ACTIONS

*Proportional Action:*

action in which contribution to output is proportional to deviation at input (deviation = difference between controlled variable and setpoint).

*Derivative Action:*

action in which contribution to output is proportional to rate of variation input deviation.

*Integral Action:*

action in which contribution to output is proportional to integral of time of input deviation.

### Influence of Proportional, Derivative and Integral actions on response of process under control

\* An increase in P.B. reduces oscillations but increases deviation.

\* A reduction in P.B. reduces the deviation but provokes oscillations of the controlled variable (the system tends to be unstable if P.B. value is too low).

\* An increase in Derivative Action corresponds to an increase in Derivative Time, reduces deviation and prevents oscillation up to a critical value of Derivative Time, beyond which deviation increases and prolonged oscillations occur.

\* An increase in Integral Action corresponds to a reduction in Integral Time, and tends to eliminate deviation between the controlled variable and the setpoint when the system is running at rated speed.

If the Integral Time value is too long (Weak integral action), deviation between the controlled variable and the setpoint may persist.

Contact GEFRA for more information on control actions.

## 11 • MANUAL TUNING

- A) Enter the setpoint at its working value.
- B) Set the proportional band at 0.1% (with on-off type setting).
- C) Switch to automatic and observe the behavior of the variable. It will be similar to that in the figure:

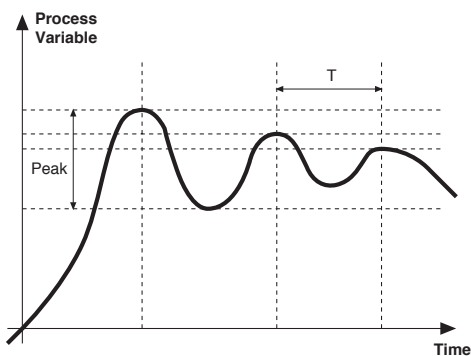

D) The PID parameters are calculated as follows: Proportional band

$$P.B. = \frac{\text{Peak}}{(V \text{ max} - V \text{ min})} \times 100$$

(V max - V min) is the scale range.

Integral time:  $I_t = 1.5 \times T$

Derivative time:  $d_t = I_t/4$

E) Switch the unit to manual, set the calculated parameters. Return to PID action by setting the appropriate relay output cycle time, and switch back to Automatic.

F) If possible, to optimize parameters, change the setpoint and check temporary response. If an oscillation persists, increase the proportional band. If the response is too slow, reduce it.

## 12 • SET GRADIENT

SET GRADIENT: if set to  $\neq 0$ , the setpoint is assumed equal to PV at power-on and auto/man switchover. With gradient set, it reaches the local setpoint. Every variation in setpoint is subject to a gradient.

The set gradient is inhibited at power-on when self-tuning is engaged.

If the set gradient is set to  $\neq 0$ , it is active even with variations of the local setpoint.

The control setpoint reaches the set value at the speed defined by the gradient.

## 13 • SOFTWARE ON / OFF SWITCHING FUNCTION

**How to switch the unit OFF:** hold down the "F" and "Raise" keys simultaneously for 5 seconds to deactivate the unit, which will go to the OFF state while keeping the line supply connected and keeping the process value displayed. The SV display is OFF.

All outputs (alarms and controls) are OFF (logic level 0, relays de-energized) and all unit functions are disabled except the switch-on function and digital communication.

**How to switch the unit ON:** hold down the "F" key for 5 seconds and the unit will switch OFF to ON. If there is a power failure during the OFF state, the unit will remain in OFF state at the next power-up (ON/OFF state is memorized).

The function is normally enabled, but can be disabled by setting the parameter Prot = Prot +16.

## 14 • SELF-TUNING

The function works for single output systems (heating or cooling). The self-tuning action calculates optimum control parameter values during process startup. The variable (for example, temperature) must be that assumed at zero power (room temperature).

The controller supplies maximum power until an intermediate value between starting value and setpoint is reached, after which it zeros power.

PID parameters are calculated by measuring overshoot and the time needed to reach peak. When calculations are finished, the system disables automatically and the control proceeds until the setpoint is reached.

**How to activate self-tuning:**

### A. Activation at power-on

1. Set the setpoint to the required value
2. Enable selftuning by setting the Stun parameter to 2 (CFG menu)
3. Turn off the instrument
4. Make sure the temperature is near room temperature
5. Turn on the instrument again

### B. Activation from keyboard

1. Make sure that key M/A is enabled for Start/Stop selftuning (code but = 6 Hrd menu)
2. Bring the temperature near room temperature
3. Set the setpoint to the required value
4. Press key M/A to activate selftuning (Attention: selftuning interrupts if the key is pressed again)

The procedure runs automatically until finished, when the new PID parameters are stored: proportional band, integral and derivative times calculated for the active action (heating or cooling). In case of double action (heating or cooling), parameters for the opposite action are calculated by maintaining the initial ratio between parameters (ex.:  $CPb = HPb \times K$ ; where  $K = CPb / HPb$  when self-tuning starts). When finished, the Stun code is automatically cancelled.

### Notes :

-The procedure does not start if the temperature is higher than the setpoint (heating control mode) or if the temperature is lower than the setpoint (cooling control mode). In this case, the Stun code is not cancelled.

-It is advisable to enable one of the configurable LEDs to signal selftuning status. By setting one of parameters LED1, LED2, LED3=4 or 20 on the Hrd menu, the respective LED will be on or flashing when selftuning is active.

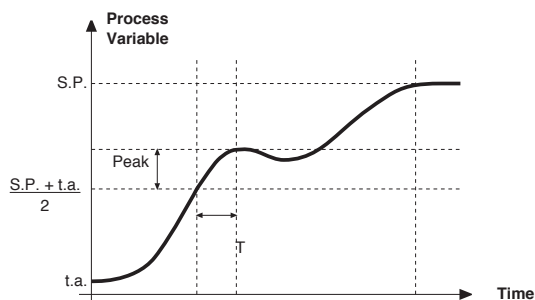

## 15 • ACCESSORIES

### • Interface for instrument configuration



Kit for PC via the USB port (Windows environment) for GEFTRAN instruments configuration:

Lets you read or write all of the parameters

- A single software for all models
- Easy and rapid configuration
- Saving and management of parameter recipes
- On-line trend and saving of historical data

Component Kit:

- Connection cable PC USB ... port TTL
- Connection cable PC USB ... RS485 port
- Serial line converter
- CD SW GF Express installation

### • ORDERING CODE

GF_eXK-2-0-0	cod F049095
--------------	-------------

## 16 • ORDER CODE

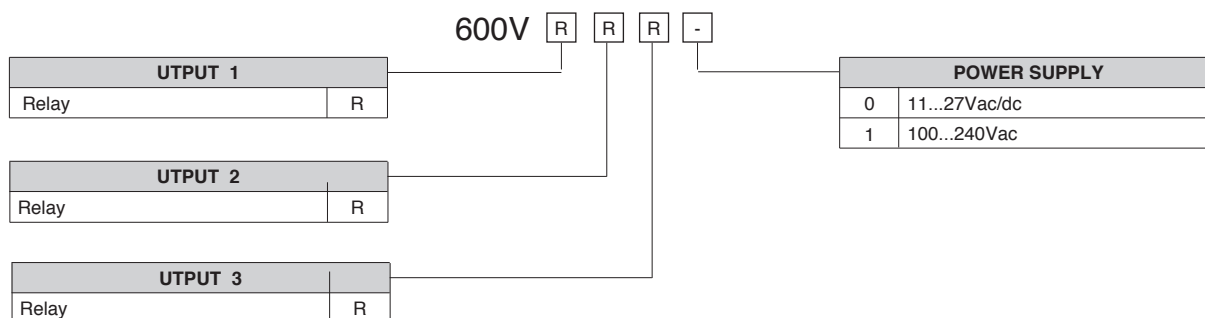

## • WARNINGS

**!** WARNING: this symbol indicates danger. It is placed near the power supply circuit and near high-voltage relay contacts.

**Read the following warnings before installing, connecting or using the device:**

- follow instructions precisely when connecting the device.
- always use cables that are suitable for the voltage and current levels indicated in the technical specifications.
- the device has no ON/OFF switch: it switches on immediately when power is turned on. For safety reasons, devices permanently connected to the power supply require a two-phase disconnecting switch with proper marking. Such switch must be located near the device and must be easily reachable by the user. A single switch can control several units.
- if the device is connected to electrically NON-ISOLATED equipment (e.g. thermocouples), a grounding wire must be applied to assure that this connection is not made directly through the machine structure.
- if the device is used in applications where there is risk of injury to persons and/or damage to machines or materials, it MUST be used with auxiliary alarm units. You should be able to check the correct operation of such units during normal operation of the device.
- before using the device, the user must check that all device parameters are correctly set in order to avoid injury to persons and/or damage to property.
- the device must NOT be used in inflammable or explosive environments. It may be connected to units operating in such environments only by means of suitable interfaces in conformity to local safety regulations.
- the device contains components that are sensitive to static electrical discharges. Therefore, take appropriate precautions when handling electronic circuit boards in order to prevent permanent damage to these components.

**Installation:** installation category II, pollution level 2, double isolation

The equipment is intended for permanent indoor installations within their own enclosure or panel mounted enclosing the rear housing and exposed terminals on the back.

- only for low power supply: supply from Class 2 or low voltage limited energy source
- power supply lines must be separated from device input and output lines; always check that the supply voltage matches the voltage indicated on the device label.
- install the instrumentation separately from the relays and power switching devices
- do not install high-power remote switches, contactors, relays, thyristor power units (particularly if "phase angle" type), motors, etc... in the same cabinet.
- avoid dust, humidity, corrosive gases and heat sources.
- do not close the ventilation holes; working temperature must be in the range of 0...50°C.

- surrounding air: 50°C
- use 60/75°C copper (Cu) conductor only, wire size range 2x No 22 - 14AWG, Solid/Stranded
- use terminal tightening torque 0.5N m

If the device has faston terminals, they must be protected and isolated; if the device has screw terminals, wires should be attached at least in pairs.

• **Power:** supplied from a disconnecting switch with fuse for the device section; path of wires from switch to devices should be as straight as possible; the same supply should not be used to power relays, contactors, solenoid valves, etc.; if the voltage waveform is strongly distorted by thyristor switching units or by electric motors, it is recommended that an isolation transformer be used only for the devices, connecting the screen to ground; it is important for the electrical system to have a good ground connection; voltage between neutral and ground must not exceed 1V and resistance must be less than 60hm; if the supply voltage is highly variable, use a voltage stabilizer for the device; use line filters in the vicinity of high frequency generators or arc welders; power supply lines must be separated from device input and output lines; always check that the supply voltage matches the voltage indicated on the device label.

• **Input and output connections:** external connected circuits must have double insulation; to connect analog inputs (TC, RTD) you have to: physically separate input wiring from power supply wiring, from output wiring, and from power connections; use twisted and screened cables, with screen connected to ground at only one point; to connect adjustment and alarm outputs (contactors, solenoid valves, motors, fans, etc.), install RC groups (resistor and capacitor in series) in parallel with inductive loads that work in AC (*Note: all capacitors must conform to VDE standards (class x2) and support at least 220 VAC. Resistors must be at least 2W*); fit a 1N4007 diode in parallel with the coil of inductive loads that operate in DC.

**GEFRAN spa will not be held liable for any injury to persons and/or damage to property deriving from tampering, from any incorrect or erroneous use, or from any use not conforming to the device specifications.**



## Set-up for 600V RRR0-1-T73 regulator

### Set up for temperature probe Pt100 (ex Siemens QAE2120 130°C max.)

The regulator comes out of the factory preset with the corresponding values of the Siemens RWF40.000 and RWF50.2x

Verify wiring of the sensor

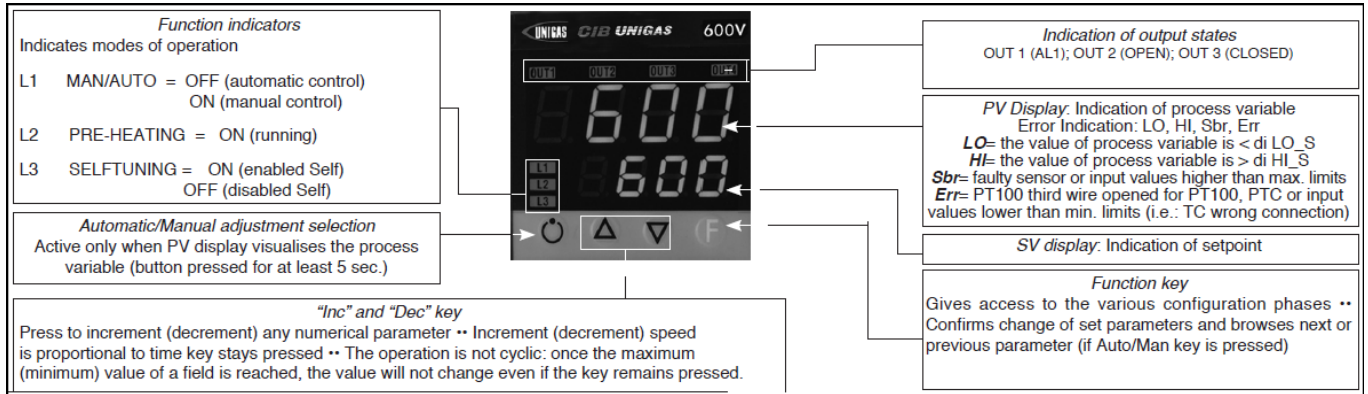

Regulation of the set-point = 80

It can be modified by using arrows "up" and "down".

By pushing F you go to parameters:

Hy.P	5 (hysteresis positive for output 1, terminals 21-22 (ex Q13-Q14))
Hy.n	-5 hysteresis negative for output ,1 terminals 21-22 (ex Q13-Q14)

Keep pushing F until you see **PASS**, release F and through the arrows set **99**, push F and visualize **Pro** (protection code) default is **12**, through the arrows set **128** and push F, keep it pushed until all parameters **InF**, **CFG**, **InP**, **Out**, **PASS** are visualized.

CFG	
S.tun	0
hPb	1,2
hIt	5,83
hdt	1,33
...	

InP	
....	
tyP	30 (Pt100)
...	
dP_S	1 (decimals num.)
Lo.S	0 (min. sensor scale)
Hi.S	850,0 (max sensor scale)
oFS	0 (offset of input correction)
Lo.L	30,0 (lower set-point range limit)
Hi.L	130,0 (upper set-point range limit)

<b>Out</b>	
A1.r	0
...	
A1.t	3 (operating mode AL1 =inverse-relative-normal)
...	
rL.1	2 (AL1)
rL.2	18 (open)
rL.3	19 (close)
rEL	0
A.ty	9 (type of servocontrol command)
Ac.t	12 (servocontrol running time: SQN72.4.../STA12..=12; SQM40.265=30)
t Lo	2
t Hi	0.0
t.on	2
t.oF	0.0
dE.b	0,1 (dead zone in % of end scale)

<b>PAS</b>	99 then push and keep pushed <b>F</b> until visualization of <b>Hrd</b>
<b>Hrd</b>	
...	
Ctrl	6 (PID warm)
AL.nr	1
but	1
diSP	0
Ld.1	1
Ld.2	28
Ld.3	20

Keep pushed **F** until you visualize **PASS**, release **F** and through the arrows set **99**, push **F** and visualize **Pro** (protection code) from **128**, through the arrows, bring it back to **12**, and keep **F** pushed until you come back to set-point value.

#### **Manual operation :**

Keep pushed the lower left key for at least 5 sec.

The instrument will enter the "MAN" mode (see also "Ld1" switching on).

Through the arrows, "Open" and "Close" outputs are activated.

To come back to normal working keep the lower left key pushed for at least 5 sec.

#### **Software switch off :**

By keeping pushed keys **Arrow up** + **F** for more than 5 sec. the instrument switches off the software, does not command the outputs and visualize only the variable of process measured by the probe.

To restore keep pushed **F** for more than 5 sec.

**Set up for temperature probe Pt100 for high temperature (350°C max.)**

Verify wiring of the sensor

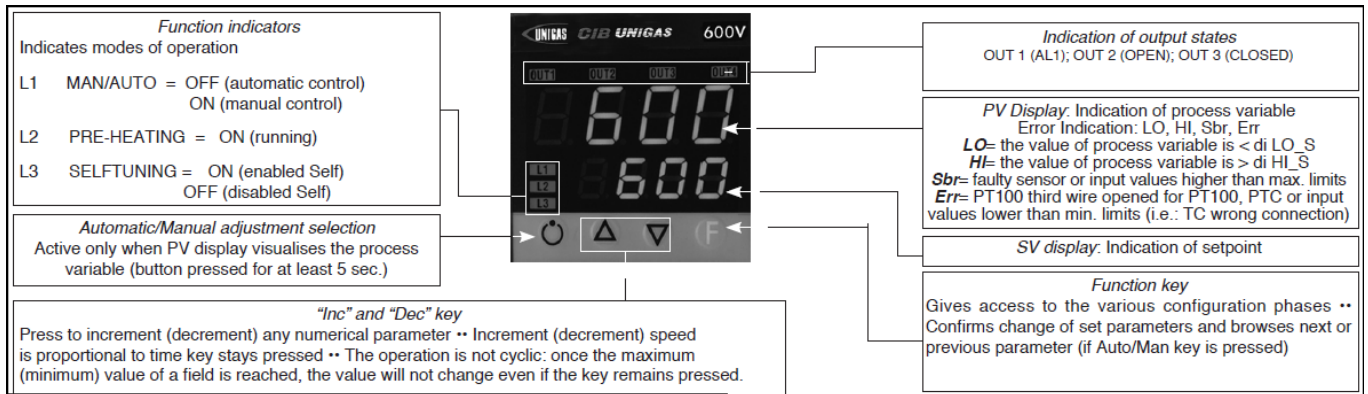

Regulation of the set-point = **80**

It can be modified by using arrows "up" and "down".

By pushing **F** you go to parameters:

Hy.P	10 (hysteresis positive for output 1 terminals 21-22 (ex Q13-Q14))
Hy.n	-5 (hysteresis negative for output 1 terminals 21-22 (ex Q13-Q14))

Keep pushing **F** until you see **PASS**, release **F** and through the arrows set **99**, push **F** and visualize **Pro** (protection code) default is **12**, through the arrows set **128** and push **F**, keep it pushed until all parameters **InF**, **CFG**, **InP**, **Out**, **PASS** are visualized.

<b>CFG</b>	
S.tun	0
hPb	1,2
hIt	5,83
hdt	1,33
...	

<b>InP</b>	
....	
tyP	30 (Pt100)
...	
dP_S	1 (decimals num.)
Lo.S	0 (min. sensor scale)
Hi.S	850,0 (max sensor scale)
oFS	0 (offset of input correction)
Lo.L	0,0 (lower set-point range limit)
Hi.L	350,0 (upper set-point range limit)

<b>Out</b>	
A1.r	0
...	
A1.t	3 (mode AL1 =inverse-relative-normal)
...	
rL.1	2 (AL1)
rL.2	18 (open)
rL.3	19 (close)
rEL	0
A.ty	9 (type of servocontrol command)
Ac.t	12 (servocontrol running time: SQN72.4.../STA12..=12; SQM40.265=30)
t Lo	2
t Hi	0.0
t.on	2
t.oF	0.0
dE.b	0,1 (dead zone in % of end scale)

<b>PAS</b>	99 then push and keep pushed <b>F</b> until visualization of <b>Hrd</b>
<b>Hrd</b>	
...	
Ctrl	6 (PID warm)
AL.nr	1
but	1
diSP	0
Ld.1	1
Ld.2	28
Ld.3	20

Keep pushed **F** until you visualize **PASS**, release **F** and through the arrows set **99**, push **F** and visualize **Pro** (protection code) from **128**, through the arrows, bring it back to **12**, and keep **F** pushed until you come back to set-point value.

#### **Manual operation:**

Keep pushed the lower left key for at least 5 sec.

The instrument will enter the "MAN" mode (see also "Ld1" switching on).

Through the arrows, "Open" and "Close" outputs are activated.

To come back to normal working keep the lower left key pushed for at least 5 sec.

#### **Software switch off :**

By keeping pushed keys **Arrow up** + **F** for more than 5 sec. the instrument switches off the software, does not command the outputs and visualize only the variable of process measured by the probe.

To restore keep pushed **F** for more than 5 sec.

## Set up for pressure transmitter 2 wires signal 4÷20mA

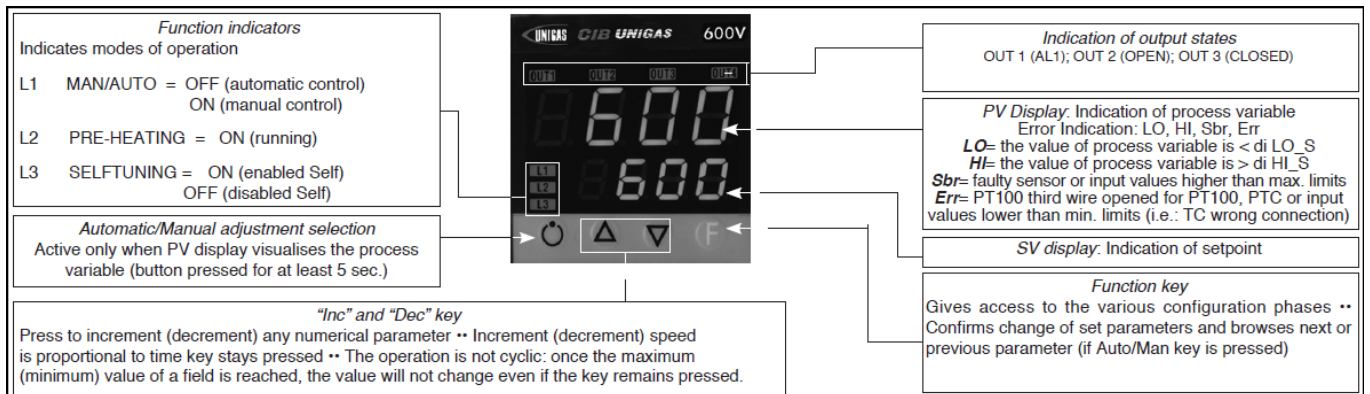

With pressure transmitters first we need to enable their power supply: remove the part as shown below, then, on the CPU unit, move the bridge from Pt100 to +Vt

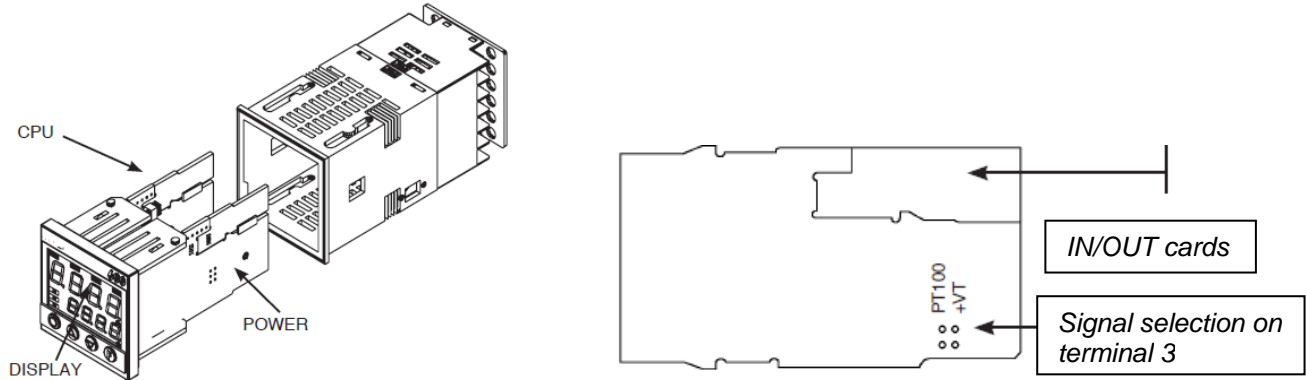

Verify wiring of the sensor

Impostazione set-point

Transmitter	1,6bar	3bar	10bar	16bar	25bar	40bar
Set-point	1bar	1,5bar	6bar	6bar	6bar	6bar

To modify it directly use "up" and "down" arrows.

By pushing **F** you go to parameter:

Transmitter	1,6bar	3bar	10bar	16bar	25bar	40bar
Hy.P	0,2bar	0,5bar	0,5bar	0,8bar	1,25bar	2bar
Hy.n	0bar	0bar	0bar	0bar	0bar	0bar

Keep pushing **F** until you see **PASS**, release **F** and through the arrows set **99**, push **F** and visualize **Pro** (protection code) default is **12**, through the arrows set **128** and push **F**, keep it pushed until all parameters **InF**, **CFG**, **InP**, **Out**, **PASS** are visualized.

CFG	
S.tun	0
hPb	5
hIt	1,33
hdt	0,33
...	

InP	
....	
tyP	44 (4÷20mA)
...	
dP_S	2 (decimals num.)

Transmitter	1,6bar	3bar	10bar	16bar	25bar	40bar	
Lo.S	0,00	0,00	0,00	0,00	0,00	0,00	min. sensor scale
Hi.S	1,60	3,00	10,00	16,00	25,00	40,00	max sensor scale
oFS	0	0	0	0	0	0	offset of input correction
Lo.L	0,00	0,00	0,00	0,00	0,00	0,00	lower set-point setting
Hi.L	1,60	3,00	10,00	16,00	25,00	40,00	upper set-point setting

Out	
A1.r	0
...	
A1.t	3 (mode AL1 =inverse-relative-normal)
...	
rL.1	2 (AL1)
rL.2	18 (open)
rL.3	19 (close)
rEL	0
A.ty	9 (type of servocontrol command)
Ac.t	12 (servocontrol running time: SQN72.4.../STA12..=12; SQM40.265=30)
t Lo	2
t Hi	0.0
t.on	2
t.oF	0.0
dE.b	0,1 (dead zone in % of end scale)

<b>PAS</b>	99 then push and keep pushed <b>F</b> until visualization of <b>Hrd</b>
<b>Hrd</b>	
...	
Ctrl	6 (PID warm)
AL.nr	1
but	1
diSP	0
Ld.1	1
Ld.2	28
Ld.3	20

Keep pushed **F** until you visualize **PASS**, release **F** and through the arrows set **99**, push **F** and visualize **Pro** (protection code) from **128**, through the arrows, bring it back to **12**, and keep **F** pushed until you come back to set-point value.

#### Manual operation:

Keep pushed the lower left key for at least 5 sec.

The instrument will enter the "MAN" mode (see also "Ld1" switching on).

Through the arrows, "Open" and "Close" outputs are activated.

To come back to normal working keep the lower left key pushed for at least 5 sec.

#### Software switch off :

By keeping pushed keys **Arrow up** + **F** for more than 5 sec. the instrument switches off the software, does not command the outputs and visualize only the variable of process measured by the probe.

To restore keep pushed **F** for more than 5 sec.

## Set-up for thermocouples type **K** or **J**

Verify wiring of the sensor

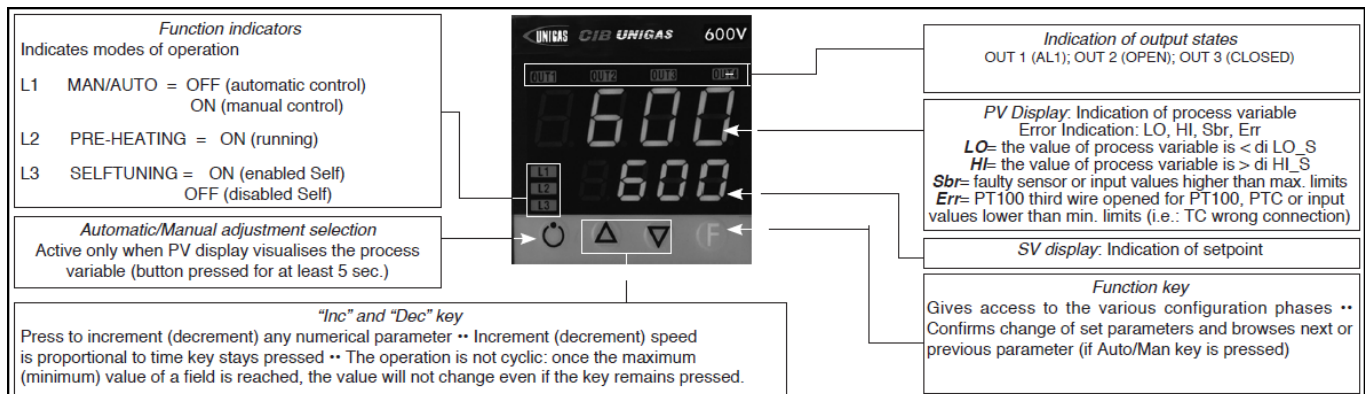

Regulation of the set-point = **80**

It can be modified by using arrows "up" and "down".

By pushing **F** you go to parameters:

Hy.P	10 (hysteresis positive for output 1 terminals 21-22 (ex Q13-Q14))
Hy.n	-5 (hysteresis negative for output 1 terminals 21-22 (ex Q13-Q14))

Keep pushing **F** until you see **PASS**, release **F** and through the arrows set **99**, push **F** and visualize **Pro** (protection code) default is **12**, through the arrows set **128** and push **F**, keep it pushed until all parameters **InF**, **CFG**, **InP**, **Out**, **PASS** are visualized.

<b>CFG</b>	
S.tun	0
hPb	1,2
hIt	5,83
hdt	1,33
...	

<b>InP</b>	
....	
tyP	2 (thermocouple <b>K</b> 0÷1300°C) / 0 (thermocouple <b>J</b> 0÷1000°C)
...	
dP_S	0 (no decimal) / 1 (1 decimal)
Lo.S	0 (min. sensor scale)
Hi.S	1300 (max sensor scale for tc <b>K</b> ) / 1000 (max sensor scale for tc <b>J</b> )
oFS	0 (offset of input correction)
Lo.L	0 (lower set-point range limit)
Hi.L	1300 (upper set-point range limit) per tc <b>K</b> / 1000 for tc <b>J</b>

<b>Out</b>	
A1.r	0
...	
A1.t	3 (mode AL1 =inverse-relative-normal)
...	
rL.1	2 (AL1)
rL.2	18 (open)
rL.3	19 (close)
rEL	0
A.ty	9 (type of servocontrol command)
Ac.t	12 (servocontrol running time: SQN72.4.../STA12..=12; SQM40.265=30)
t Lo	2
t Hi	0.0
t.on	2
t.oF	0.0
dE.b	0,1 (dead zone in % of end scale)

<b>PAS</b>	99 then push and keep pushed <b>F</b> until visualization of <b>Hrd</b>
...	
<b>Hrd</b>	
...	
Ctrl	6 (PID warm)
AL.nr	1
but	1
diSP	0
Ld.1	1
Ld.2	28
Ld.3	20

Keep pushed **F** until you visualize **PASS**, release **F** and through the arrows set **99**, push **F** and visualize **Pro** (protection code) from **128**, through the arrows, bring it back to **12**, and keep **F** pushed until you come back to set-point value.

#### Manual operation:

Keep pushed the lower left key for at least 5 sec.

The instrument will enter the "MAN" mode (see also "Ld1" switching on).

Through the arrows, "Open" and "Close" outputs are activated.

To come back to normal working keep the lower left key pushed for at least 5 sec.

#### Software switch off :

By keeping pushed keys **Arrow up** + **F** for more than 5 sec. the instrument switches off the software, does not command the outputs and visualize only the variable of process measured by the probe.

To restore keep pushed **F** for more than 5 sec.





**MANUAL FOR  
OPERATION AND  
CALIBRATION**

**MODULATOR**

**SIEMENS RWF 40....**

## INSTRUMENT MOUNTING

Mount the instrument using the relevant mounts as illustrated in the figure.

To wire the instrument and sensors, follow the instructions given on the burner's wiring diagrams.

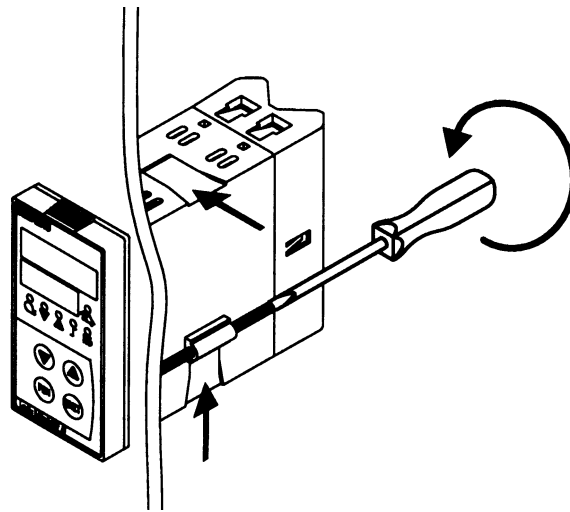

## INSTRUMENT FRONTAL PANEL

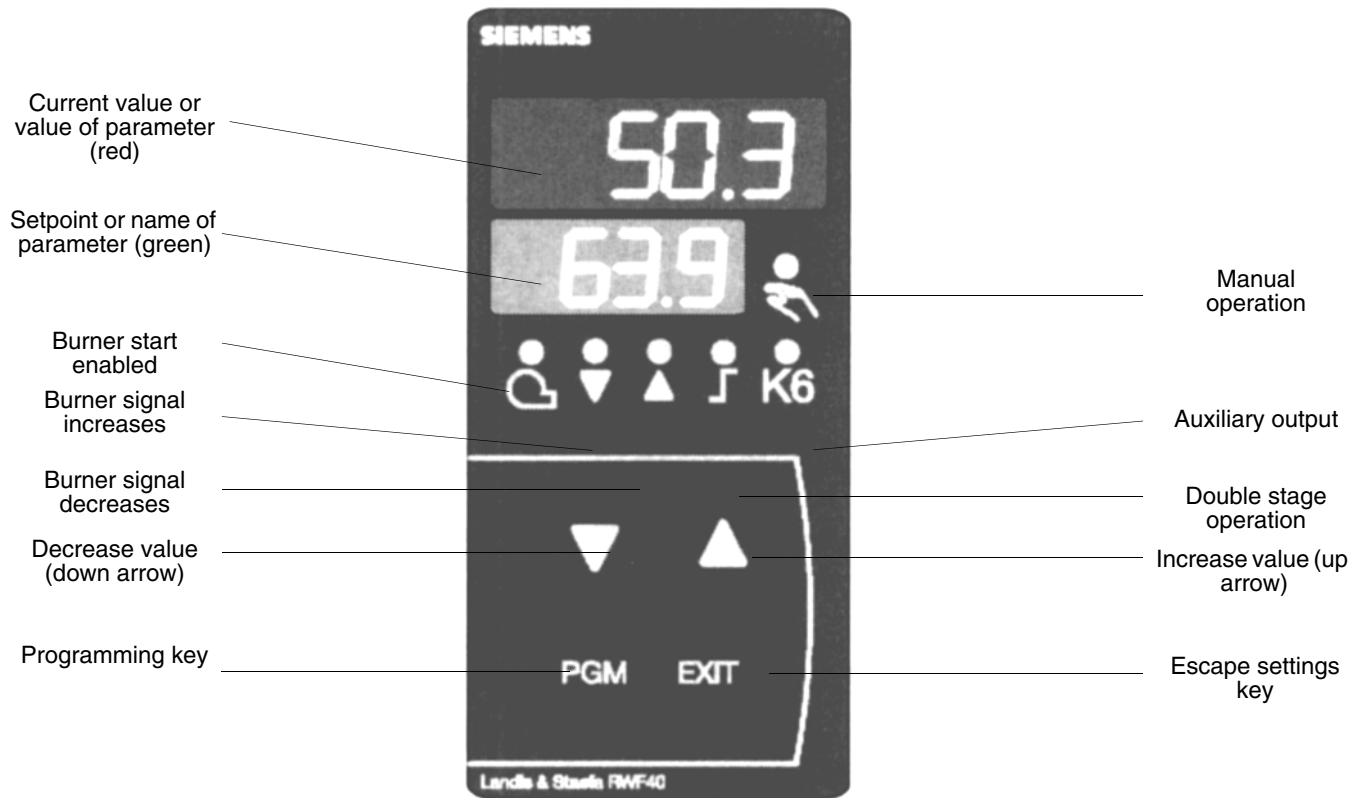

---

## INSTRUMENT SETTINGS

The instrument comes with a number of factory settings that are good for 90% of cases. However, you can set or edit parameters proceeding as follows

### 1. Setting or editing of setpoint value

With the burner switched off (thermostat/pressure switch series contacts open, i.e. terminals 3-4 open), press the PGM key, holding it down for less than 2 sec.. The display at the bottom (green) reads SP1: use the up and down arrows to set the setpoint value on the display at the top (red).

To confirm the value, press the **PGM** key, then press **EXIT** to return to normal operation.

### 2. Checking or editing the instrument's PID parameters (table 1 attached)

- Press the PGM key, holding it down for longer than 2 sec.. The code AL appears on the green display whilst the red display reads 0
- reads 0.
- To change, use the up and down arrows to change the value on the red display.
- To confirm, press PGM and the green display moves on to the next parameter.
- Repeat the previous operations for all parameters.
- To stop, press the EXIT key.
- For a list of PID parameters, see table (1) attached.

### 3. Setting the kind of sensor to be connected to the instrument (table 2 attached)

- With the instrument in normal operating mode, press the **PGM** key, holding it down for 2 sec.. The instrument enters PID parameter configuration mode, hence press the **PGM** key for another 2 sec.
- The green display features the code **C111** whilst the red display gives the code **9030**.
- Each digit of the code corresponds to a settable parameter
- When the down arrow is pressed, the first digit on the left (n°9) on the red display starts flashing. Pressing the up arrow while the digit is flashing, you can change the value according to table (2) attached .
- Once you have edited the value, press the down arrow again and the second digit from the left (n°0) starts flashing and so on for all four digits. Press **PGM** to confirm and **EXIT** to exit.

Example: temperature sensor, set **9030**; pressure sensor, set **G030**.

### 4. C112 and C113 configurations (tables 3 & 4 attached) :

Configurations **C112** and **C113** enable use of an auxiliary contact (terminals Q63-Q64 and LED K6 on the front panel), which is fully configurable.

It also allows you to choose between degrees Celsius °C or Fahrenheit °F and to lock the instrument's keys.

With the instrument in normal operating mode, press the **PGM** key, holding it down for 2 sec.. The instrument enters PID parameter configuration mode, hence press the **PGM** key for another 2 sec..

The code **C111** appears on the green display whilst the red display reads **9030**. If you press **PGM** again, the green display reads **C112** and the red display reads **0110**.

For the instrument to work as standard, the **C112** configuration should never be altered, whilst the **C113** configuration should be changed when using pressure sensors or 0-10V / 0.4-20mA signals (see table (5) attached).

### 5. Configuring process values:

With the instrument in normal operating mode, press the **PGM** key for 2 sec.. The instrument enters PID parameter configuration mode. The code **C111** appears on the green display, whilst the code 9030 (or different code depending on settings made previously) appears on the red display. If you press **PGM** again, the code becomes **C112** and the red display reads 0010. When you next press **PGM**, the code becomes **C113** and the red display reads 0110. When you next press **PGM**, the green display reads **SCL** (=lower limit [instrument range start] for analogue input 1, valid for signals 0-10V, 0-20mA, 4-20mA, 0-100ohms etc.). Use the up arrow or down arrow to set the chosen value (see table (5) attached).

If you press the **PGM** key again, the green display reads **SCH** (=upper limit [instrument range end] for analogue input 1, valid for input signals 0-10V, 0-20mA, 4-20mA, 0-100ohms etc.). Use the up and down arrow to set the chosen value (see table (5) attached).

Example: for SIEMENS pressure sensor QBE2.. P25 (25bar), the input signal used is 0-10V: set **SCL** to 0 and **SCH** to 2500. That way the instrument's scale ranges from 0 to 2500 kPa (25 bar).

Pressing the **PGM** key repeatedly calls up the following parameters in sequence. These parameters can be edited with the up and down arrows:

---

**SCL2**:lower limit for analogue input 2 (same as SCL but for input 2 - factory setting 0);

**SCH2**:upper limit for analogue input 2 (same as SCH but for input 2 - factory setting 100);

**SPL**: lower setpoint limit (same as SCL but for setpoint - factory setting 0);

**SPH**: upper setpoint limit (same as SCH but for setpoint - factory setting 100);

Example: for SIEMENS pressure sensor QBE2.. P25 (25bar), the input signal used is 0-10V: if you want to work between 5 and 19 bar, set **SPL** to 500 and **SPH** to 1900 (kPa). That way the setpoint scale can be set between 500 and 1900 kPa (5 and 19 bar).

**OFF1**:correction for analogue input 1 (factory setting 0)

**OFF2**:correction for analogue input 2 (factory setting 0)

**OFF3**:correction for analogue input 3 (factory setting 0)

**HYST**:"K6" auxiliary contact differential (factory setting 1)

**dF1**: delay applied to sensor signal to prevent transients (range 0-100sec.; factory setting 1 sec.)

## 6. Manual control

- To control burner output manually, press the **EXIT** key for 5 sec. with the burner operating - the LED with the hand symbol lights.
- At this point, use the up arrow and down arrow to increase or decrease burner output.
- To exit manual mode, press the **EXIT** key.
- NB: Every time the controller switches the burner off (start enabled LED off - Q13-Q14 contact open), manual mode is disabled when the burner is switched back on.

## 7. Instrument self-setting (auto-tuning)

- If the burner in the steady state does not respond properly to heat generator requests, you can activate the instrument's self-setting function, which recalculates PID values for its operation, deciding which are most suitable for the specific kind of request
- To activate this function, proceed as follows:
- Press the **PGM** key and down arrow at the same time.
- The green display reads tunE and the instrument forces the burner to increase and decrease output.
- During these output oscillations, the instrument calculates the PID parameters (proportional band, integral time, derivative time).
- At the end of calculations, the tunE function switches off automatically and the instrument has stored the new parameters.
- If you want to disable the self-setting function, press the up arrow once it has started.
- PID parameters calculated by the instrument can be edited at any time following the procedure illustrated earlier in point 2.

### Note:

**If no key is pressed for ~10sec. during the instrument's setting, the instrument automatically exits setting mode and returns to normal operating mode.**

**TABLE 1 - "PID" PARAMETERS AND RELEVANT FACTORY SETTINGS**

Parameter	Display	Values range	Factory setting	Remarks
Limit value for auxiliary contact (*)	AL	from -1999 to 9999 digit	0	Do not alter
Auxiliary contact switching differential (*)	HYST	from 0 to 999.9 digit	1	Do not alter
Proportional band (*)	PB.1	from 0.1 to 9999 digit	10	Typical value for temperature
Derivative action	dt	from 0 to 9999 sec.	80	Typical value for temperature
Integral action	rt	from 0 to 9999 sec.	350	Typical value for temperature
Dead band (*)	db	from 0 to 999.9 digit	1	Typical value
Servocontrol running time	tt	from 10 to 3000 sec.	15	Set servocontrol running time
Switch-on differential (*)	HYS1	from 0.0 to -199.9 digit	-5	Value under setpoint below which the burner switches back on (Q13-Q14 closes)
Lower switch-off differential (*)	HYS2	from 0.0 to HYS3	3	Do not alter
Upper switch-off differential (*)	HYS3	from 0.0 to 999.9 digit	5	Value over setpoint above which the burner switches off (Q13-Q14 opens)
Modulating response threshold	q	from 0.0 to 999.9	0	Do not alter
Weather compensation gradient	H	from 0.0 to 4	1	Do not alter
Ambient temperature parallel displacement (*)	P	from -90 to +90	0	Do not alter

(\*) Parameters affected by setting of decimal place (C113 configuration 01X0)

**TABLE 2 - INPUTS CONFIGURATION C111**

<b>Red display</b>				
<b>Analog input 1</b>	<b>1^ digit</b>	<b>2^ digit</b>	<b>3^ digit</b>	<b>4^ digit</b>
Pt100 3 wires	0			
Pt100 22 wires	1			
Ni100 3 wires	2			
Ni100 22 wires	3			
Pt1000 3 wires	4			
Pt 1000 22 wires	5			
Ni1000 3 wires DIN 43760	6			
Ni1000 22 wires DIN 43760	7			
Ni1000 3 wires Siemens	8			
Ni1000 22 wires Siemens	9			
Thermocoupling K NiCr-Ni	A			
Thermocoupling T Cu-Con	b			
Thermocoupling N NiCrSiI-NiSiI	C			
Thermocoupling J Fe-Con	d			
Signal 0 ÷ 20 mA	E			
Signal 4 ÷ 20 mA	F			
Signal 0 ÷ 10 V	G			
Signal 0 ÷ 1 V	H			
<b>Analog input 2</b>				
none		0		
external set point WFG		1		
external set point 0 ÷ 20 mA		2		
external set point 4 ÷ 20 mA		3		
external set point 0 ÷ 10 V		4		
external set point 0 ÷ 1 V		5		
analog shift set-point WFG		6		
analog shift set-point 0 ÷ 20 mA		7		
analog shift set-point 4 ÷ 20 mA		8		
analog shift set-point 0 ÷ 10 V		9		
analog shift set-point 0 ÷ 1 V		A		
<b>Analog input 3</b>				
none			0	
external temperature sensor Pt 1000 22 wires			1	
external temperature sensor Ni1000 22 wires DIN			2	
external temperature sensor Ni1000 22 wires Siemens			3	
<b>Input D2 - Logic functions</b>				
none				0
changeover set-point				1
V shift set-point				2
<b>Typical settings</b>				
<b>Siemens sensors QAE2../QAC2../QAM2..</b>	<b>9</b>	<b>0</b>	<b>3</b>	<b>0</b>
<b>Factory sensors Pt1000 30÷130 °C</b>	<b>5</b>	<b>0</b>	<b>3</b>	<b>0</b>
<b>Factory sensors Pt1000 0 ÷ 350 °C</b>	<b>5</b>	<b>0</b>	<b>3</b>	<b>0</b>
<b>Pressure probes QBE... 3 wires (signal 0 ÷ 10 V)</b>	<b>G</b>	<b>0</b>	<b>3</b>	<b>0</b>
<b>Pressure probes MBS... 2 wires (signal 4 ÷ 20 mA)</b>	<b>F</b>	<b>0</b>	<b>3</b>	<b>0</b>
<b>Probes Pt100 3 wires</b>	<b>0</b>	<b>0</b>	<b>3</b>	<b>0</b>
<b>Thermocouplings K type</b>	<b>A</b>	<b>0</b>	<b>3</b>	<b>0</b>
<b>Signal 4 ÷ 20 mA</b>	<b>F</b>	<b>0</b>	<b>3</b>	<b>0</b>

**TABLE 3 - CONFIGURATION C112**

Red display	1^ digit	2^ digit	3^ digit	4^ digit
<b>Auxiliary limit switch K6</b>				
none	0			
lk1 function for input 1	1			
lk2 function for input 1	2			
lk3 function for input 1	3			
lk4 function for input 1	4			
lk5 function for input 1	5			
lk6 function for input1	6			
lk7 function for input 1	7			
lk8 function for input 2	8			
lk7 function for input 2	9			
lk8 function for input 2	A			
lk7 function for input 3	b			
lk8 function for input 3	C			
<b>Type of instrumentoutput control</b>				
3 points (relay type)		0		
DC 0 ÷ 20 mA (*)		1		
DC 4 ÷ 20 mA (*)		2		
DC 0 ÷ 10 V (*)		3		
<b>Set-point SP1</b>				
SP1set with keys			0	
<b>SP1 dependent on outside sensor (analogue input 3 must be configured)</b>			1	
<b>Parameter lock</b>				
no keyboard lock				0
configuration level block				1
parameters level block PID				2
total block				3
<b>Factory settings</b>				
	0	0	1	0

**Note: (\*) for RWF 40.002 only**

**TABLE 4 - CONFIGURATION C113**

<b>Red display</b>	<b>1^ digit</b>	<b>2^ digit</b>	<b>3^ digit</b>	<b>4^ digit</b>
<b>Instrument addresses (for RWF 40.003 only</b>				
<b>address 0</b>	<b>0</b>			
<b>address 1</b>	<b>0</b>	<b>1</b>		
address...	...	...		
address 99	9	9		
<b>Unit of measurement and decimal place</b>				
°C without decimal			0	
<b>°C and 1 decimal</b>			<b>1</b>	
°F without decimal			2	
°F and 1 decimal			3	
<b>Activation of "K6"</b>				
<b>limit contact OFF</b>				<b>0</b>
limit contact ON				1
<b>Factory settings</b>	<b>0</b>	<b>1</b>	<b>1</b>	<b>0</b>

**TABLE 5 - SUMMARY OF STANDARD PARAMETER SETTINGS**

SENSORS/PROBES	PARAMETERS TO BE EDITED												
	C111	C113	SCL	SCH	SPL	SPH	HYS1 (*)	HYS3 (*)	Pb. 1	dt	rt	SP1 (*)	
Siemens QAE2120.010	9030	0110	-	-	30	95	-5	5	10	80	350	80°C	
Siemens QAM2120.040	9030	0110	-	-	0	80	-2,5	2,5	10	80	350	40°C	
Pt1000 (130°C max.)	5030	0110	-	-	30	95	-5	5	10	80	350	80°C	
Pt1000 (350°C max.)	5030	0110	-	-	0	350	-5	10	10	80	350	80°C	
Pt100 (130°C max.)	0030	0110	-	-	0	95	-5	5	10	80	350	80°C	
Pt100 (350°C max)	0030	0110	-	-	0	350	-5	10	10	80	350	80°C	
Termocouple K	A030	0110	-	-	0	1200	-5	20	10	80	350	80°C	
Danfoss/Siemens 4÷20mA p 1,6 bar	F030	0100	0	160	0	160	0	20	5	20	80	100kPa	
Danfoss/Siemens 4÷20mA p 10 bar	F030	0100	0	1000	0	1000	0	50	5	20	80	600kPa	
Danfoss/Siemens 4÷20mA p 16 bar	F030	0100	0	1600	0	1600	0	80	5	20	80	600kPa	
Danfoss/Siemens 4÷20mA p 25 bar	F030	0100	0	2500	0	2500	0	125	5	20	80	600kPa	
Danfoss/Siemens 4÷20mA p 40 bar	F030	0100	0	4000	0	4000	0	200	5	20	80	600kPa	
Siemens QBE2.. P4	G030	0100	0	400	0	400	0	20	5	20	80	200kPa	
Siemens QBE2.. P10	G030	0100	0	1000	0	1000	0	50	5	20	80	600kPa	
Siemens QBE2.. P16	G030	0100	0	1600	0	1600	0	80	5	20	80	600kPa	
Siemens QBE2.. P25	G030	0100	0	2500	0	2500	0	125	5	20	80	600kPa	
Siemens QBE2.. P40	G030	0100	0	4000	0	4000	0	200	5	20	80	600kPa	
Signal 0÷10V	G030	to be fixed	to be fixed	to be fixed	to be fixed	to be fixed	to be fixed	to be fixed	to be fixed	5	20	80	to be fixed
Signal 4÷20mA	F030	to be fixed	to be fixed	to be fixed	to be fixed	to be fixed	to be fixed	to be fixed	to be fixed	5	20	80	to be fixed
tt - servocontrol run	12 sec.	Servocontrol Berger STA12B.../Siemens SQN30.251/Siemens SQN72.4A4A20											
tt - servocontrol run	13 sec.	Servocontrol Berger STA13B...											
tt - servocontrol run	15 sec.	Servocontrol Berger STA15B...											
tt - servocontrol run	30 sec.	Servocontrol Siemens SQL33.03/Siemens SQM10/Siemens SQM50/Siemens SQM54/Berger STM30../Siemens SQM40.265											

**NOTES**

(\*) These values are factory set - values must be set during operation at the plant based on the real working temperature/pressure value.

**WARNING**

With pressure sensors, parameters SP1, SCH, SCL, HYS1, HYS3 must be selected and displayed in kPa (kilo Pascal).  
(1bar = 100,000Pa = 100kPa)

**Probe electric connection :**

**With 7 pins connector version**

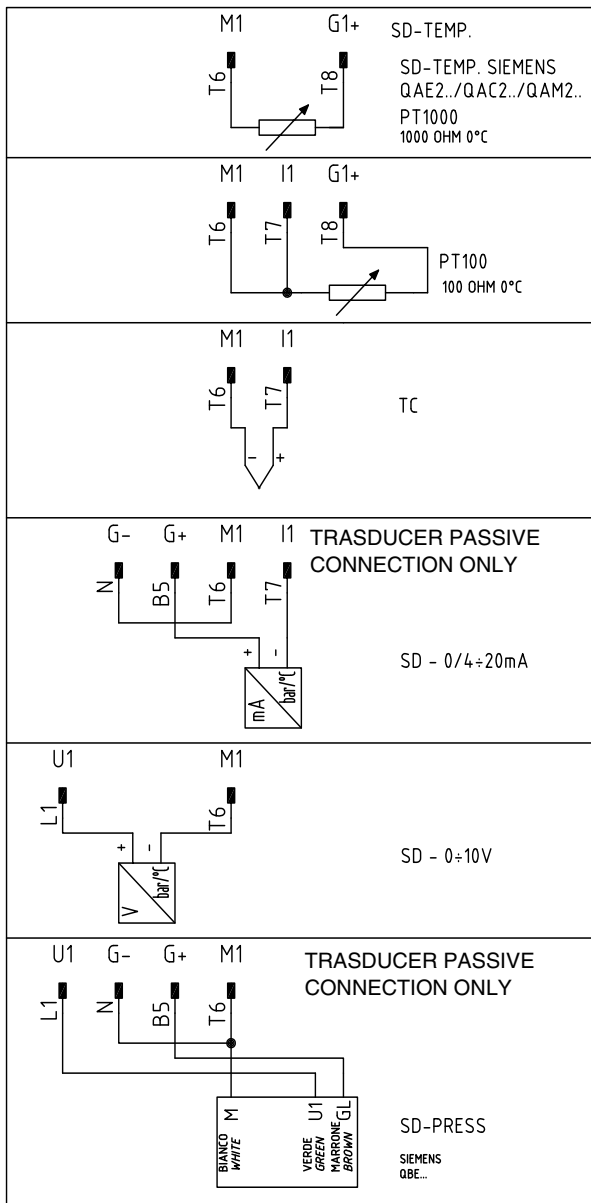

**With terminals version**

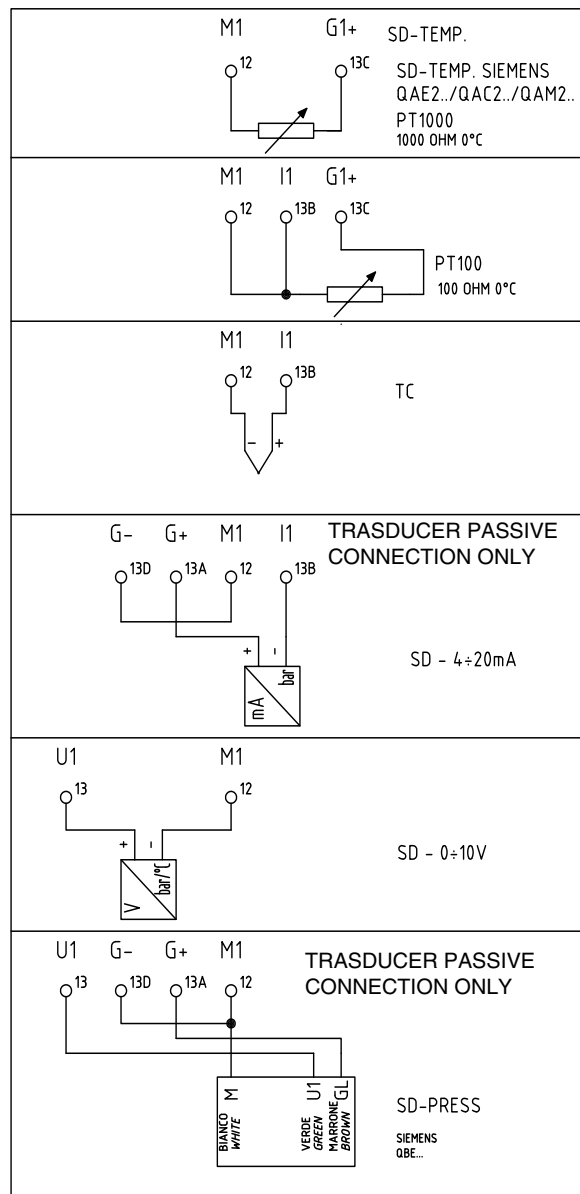

---

**With external setpoint**

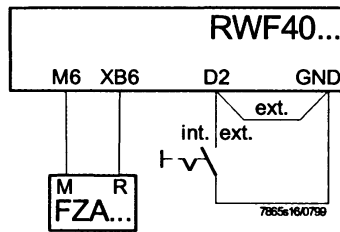

C111 configuration code = X1X1

**With setpoint modified by independent management system**

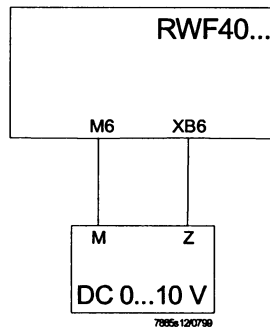

C111 configuration code = X9XX

$$\text{SCH2} = 0.5 \times (\text{SPH} - \text{SPL})$$
$$\text{SCL2} = -0.5 \times (\text{SPH} - \text{SPL})$$

Example:

SPH = max. 130° C

SPL = min. 30° C

$$\text{SCH2} = 0.5 \times (130 - 30) = 50$$

$$\text{SCL2} = -0.5 \times (130 - 30) = -50$$

**APPENDIX: PROBES CONNECTION**

To assure the utmost comfort, the control system needs reliable information, which can be obtained provided the sensors have been installed correctly.

Sensors measure and transmit all variations encountered at their location.

Measurement is taken based on design features (time constant) and according to specific operating conditions.

With wiring run in raceways, the sheath (or pipe) containing the wires must be plugged at the sensor's terminal board so that currents of air cannot affect the sensor's measurements

**Ambient probes (or ambient thermostats)**

**Installation**

The sensors (or room thermostats) must be located in reference rooms in a position where they can take real temperature measurements without being affected by foreign factors.

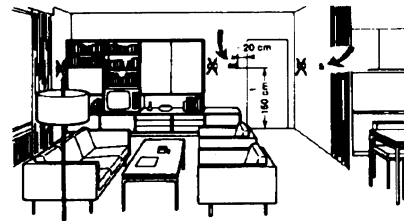
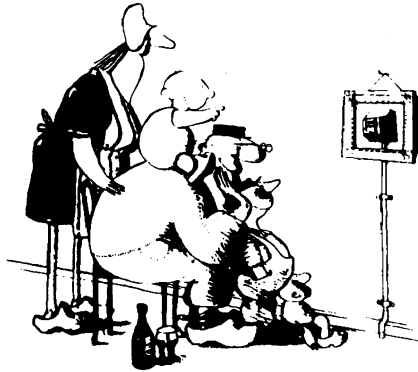

**Outside probes (weather)**

**Installation**

In heating or air-conditioning systems featuring adjustment in response to outside temperature, the sensor's positioning is of paramount importance.

**It's good to be admired ...even better to be effective**

Heating systems: the room sensor must not be installed in rooms with heating units complete with thermostatic valves. Avoid all sources of heat foreign to the system.

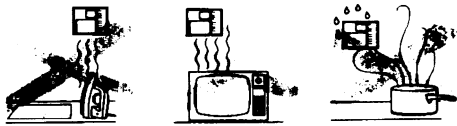

**General rule:** on the outer wall of the building where the living rooms are, never on the south-facing wall or in a position where they will be affected by morning sun. If in any doubt, place them on the north or north-east façade

**Location**

On an inner wall on the other side of the room to heating units height above floor 1.5 m, at least 1.5 m away from external sources of heat (or cold)

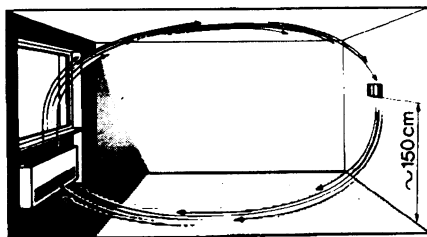

**Installation position to be avoided**

near shelving or alcoves and recesses, near doors or windows, inside outer walls exposed to solar radiation or currents of cold air, on inner walls with heating system pipes, domestic hot water pipes, or cooling system pipes running through them.

**Positions to be avoided**

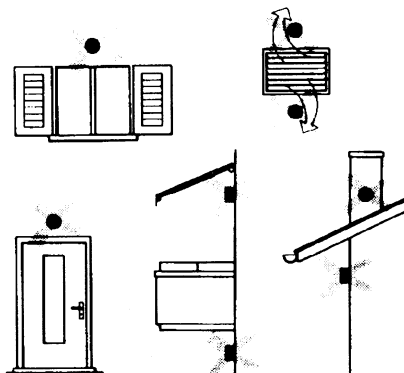

Avoid installing near windows, vents, outside the boiler room, on chimney breasts or where they are protected by balconies, cantilever roofs.

**The sensor must not be painted (measurement error).**

**Duct or pipe sensors**

**Installing temperature sensors**

For measuring outlet air:

- after delivery fan or
- after coil to be controlled, at a distance of at least 0,5 m

For measuring room temperature:

- before return air intake fan and near room's return air intake. For measuring saturation temperature: after mist eliminator.

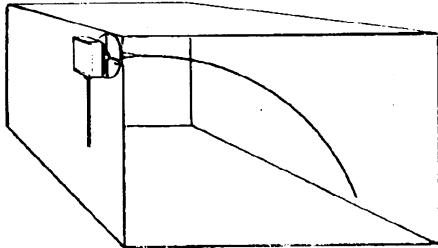

Bend 0.4m sensor by hand (never use tools) as illustrated.

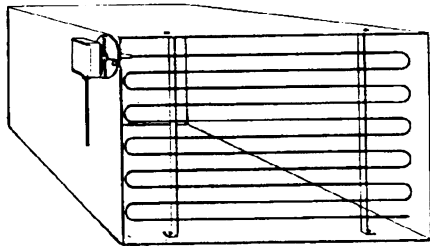

Use whole cross-section of duct, min. distance from walls 50 mm, radius of curvature 10 mm for 2m or 6m sensors.

**Installing combined humidity sensors**

As max. humidity limit sensor on outlet (steam humidifiers).

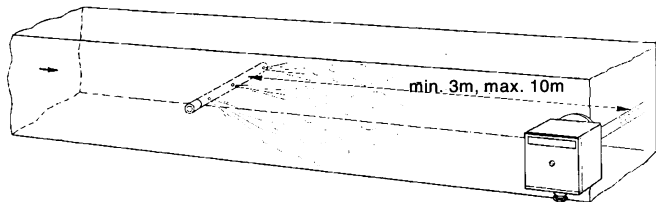

**Installing pressure sensors**

A - installation on ducts carrying fluids at max. temperature 80°C

B - installation on ducts at temperature over 80°C and for refrigerants

C - installation on ducts at high temperatures:

- increase length of siphon
- place sensor at side to prevent it being hit by hot air coming from the pipe.

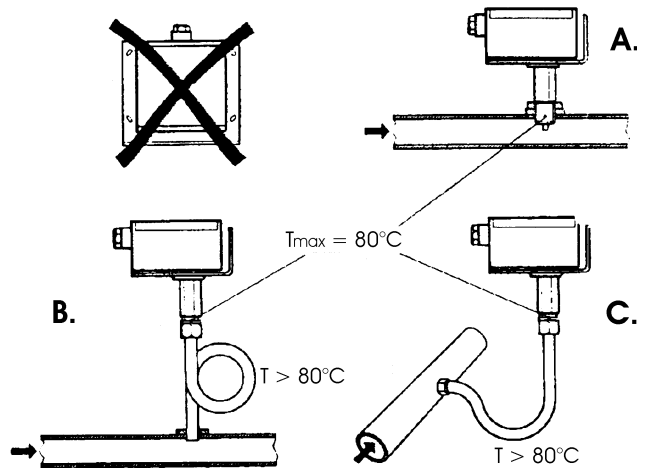

**Installing differential pressure sensors for water**

- Installation with casing facing down not allowed. -With temperature over 80°C, siphons are needed
- To avoid damaging the sensor, you must comply with the following instructions

**when installing:**

- make sure pressure difference is not greater than the value permitted by the sensor
- when there are high static pressures, make sure you insert shutoff valves A-B-C.

**Putting into operation**

start disable

1=open C1=open C

2=open A2=close B

3=open B3=close A

4= close C

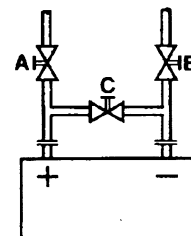

## Immersion or strap-on sensors

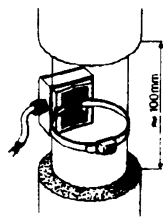
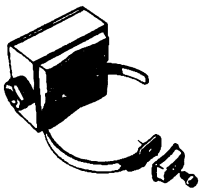
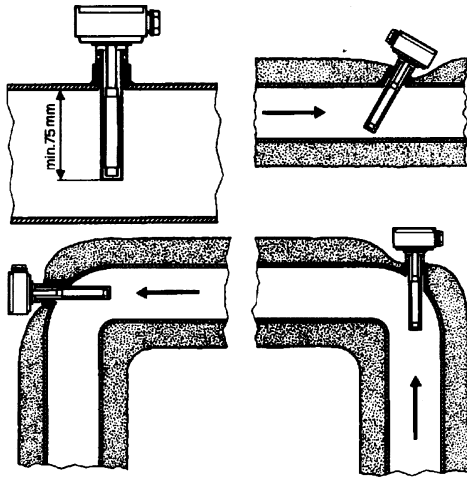

### Immersion probes mounting

Sensors must be installed on the stretch of pipe in which fluid circulates all the time.

The rigid stem (sensing element doing the measuring) must be inserted by at least 75mm and must face the direction of flow.

Recommended locations: on a bend or on a straight stretch of pipe but tilted by 45° and against the flow of fluid.

Protect them to prevent water from infiltrating (dripping gates, condensation from pipes etc.)

### Installing QAD2.. strap-on sensors

Make sure fluid is circulating in the chosen location.

Eliminate insulation and paintwork (including rust inhibitor) on a min. 100mm length of pipe.

Sensors come with straps for pipes up to 100 mm in diameter

## Placing the probes (QAD2.../QAE21.../QAP21.../RCA...)

### With pumps on outlet

with 3 ways valves / with 4 ways valves



Panel system / burner control

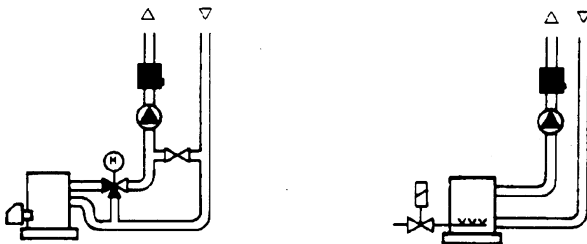

### With pumps on return

with 3 ways valves / with 4 ways valves



### Strap-on or immersion sensors?

#### QAD2.. strap-on sensors

Advantages

- 10 sec. time constant
- Installed with system running (no plumbing work)
- Installation can be changed easily if it proves incorrect.

Limits:

Suitable for pipe diameters max. 100 mm

- Can be affected by currents of air etc.

#### QAE2... immersion sensors

Advantages

- Measure "mean" fluid temperature
- No external influence on measurement such as: currents of air, nearby pipes etc.

Limits

- Time constant with sheath: 20 sec.
- Hard to change installation position if it proves incorrect.

**Duct pressure switches and sensors**

Installing differential pressure probes for air

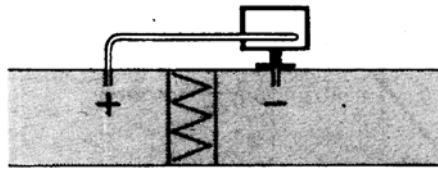

A - Control a filter (clogging)

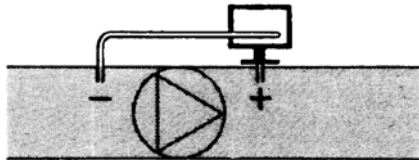

B - Control a fan (upstream/downstream)

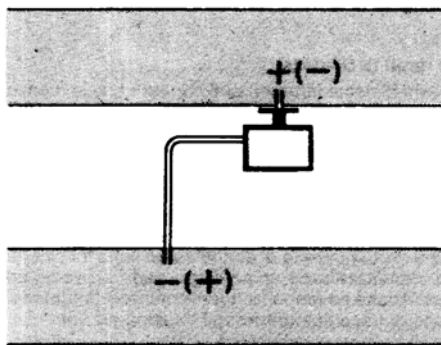

C - Measurement of difference in pressure between two ducts

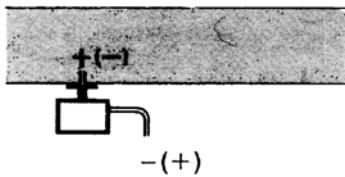

D - Measurement of difference in pressure between two rooms or of inside of duct and outside

**Basic principles**

Measuring static pressure  
(i.e. pressure exerted by air on pipe walls)

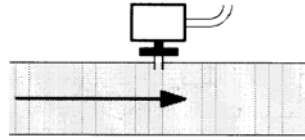

Measuring dynamic pressure

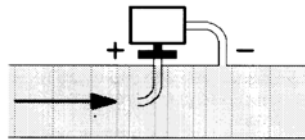

$$Pd = \frac{\gamma v^2}{2g}$$

**Key**

- y kg/m<sup>3</sup>, specific weight of air
- q m/s, air speed
- g 9.81 m/s<sup>2</sup>, gravity acceleration
- Pd mm C.A., dynamic pressure

**Measuring total pressure**

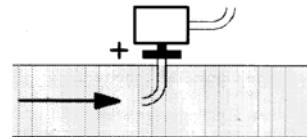

**Pressure probes connection Siemens QBE 2...P... to burner's terminal block**

SONDA DI PRESSIONE  
PRESSURE SENSOR  
SONDE DE PRESSION  
QBE 2..P...

MORSETTIERA BRUCIATORE  
BURNER TERMINAL BLOCK  
BORNIER DU BRÛLEUR

BLANC - BIANCO  
WHITE  
VERT - VERDE  
GREEN  
BRUN - MARRONE  
BROWN

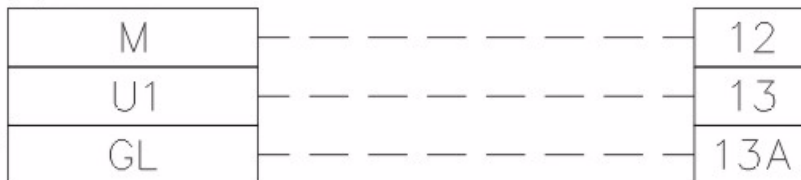

---

**Spare parts**

Description	Code
Modulator RWF40.000	2570112
Adapting frame Siemens ARG40 from RWF32.. to RWF40..	2570113
Temperature probe Siemens QAE2120.010A (30÷130°C)	2560101
Temperature probe Siemens QAM2120.040 (-15÷+50°C)	2560135
Thermoresistor Pt1000 $\varnothing$ = 6mm L = 100mm (30÷130°C)	2560188
Thermoresistor Pt1000 $\varnothing$ = 10mm L = 200mm (0÷350°C)	2560103
Pressure probe Siemens QBE2.. P4 (0÷4bar)	2560159
Pressure probe Siemens QBE2.. P10 (0÷10bar / signal 0÷10V)	2560160
Pressure probe Siemens QBE2.. P16 (0÷16bar / signal 0÷10V)	2560167
Pressure probe Siemens QBE2.. P25 (0÷25bar/ signal 0÷10V)	2560161
Pressure probe Siemens QBE2.. P40 (0÷40bar / signal 0÷10V)	2560162
Pressure probe Danfoss MBS3200 p 1,6 (0÷1,6bar / segnale 4÷20mA)	2560189
Pressure probe Danfoss MBS3200 p 10 (0÷10bar / segnale 4÷20mA)	2560190
Pressure probe Danfoss MBS3200 p 16 (0÷16bar / segnale 4÷20mA)	2560191
Pressure probe Danfoss MBS3200 p 25 (0÷25bar / segnale 4÷20mA)	2560192
Pressure probe Danfoss MBS3200 p 40 (0÷40bar / segnale 4÷20mA)	2560193
Pressure probe Siemens 7MF1564-3BB00-1AA1 (0÷1,6bar / segnale 4÷20mA)	25601A3
Pressure probe Siemens 7MF1564-3CA00-1AA1 (0÷10bar / segnale 4÷20mA)	25601A4
Pressure probe Siemens 7MF1564-3CB00-1AA1 (0÷16bar / segnale 4÷20mA)	25601A5
Pressure probe Siemens 7MF1564-3CD00-1AA1 (0÷25bar / segnale 4÷20mA)	25601A6
Pressure probe Siemens 7MF1564-3CE00-1AA1 (0÷40bar / segnale 4÷20mA)	25601A7
Thermocoupling type K $\varnothing$ = 10mm L = 200mm (0÷1200°C)	2560142
Thermoresistor Pt100 $\varnothing$ = 10mm L = 200mm (0÷350°C)	2560145

# RWF50.2x & RWF50.3x



*User manual*

## DEVICE INSTALLATION

Install the device using the relevant tools as shown in the figure.

To wire the device and sensors, follow the instructions on the burner wiring diagram.

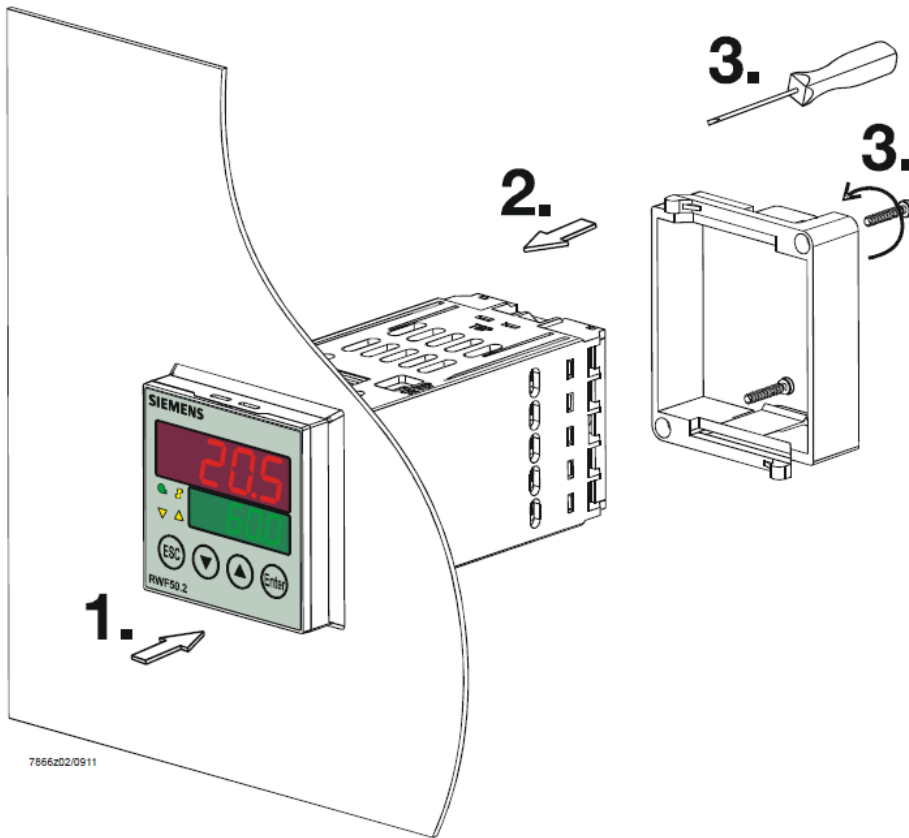

7866202/0911

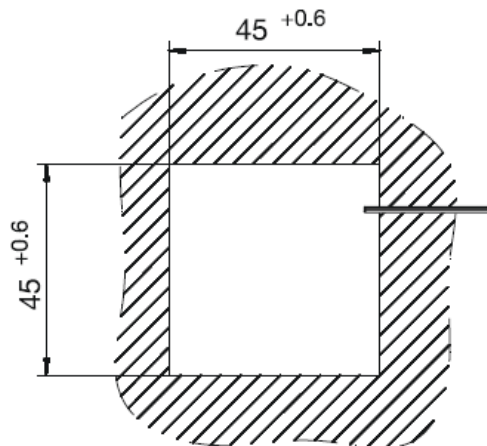

# FRONT PANEL

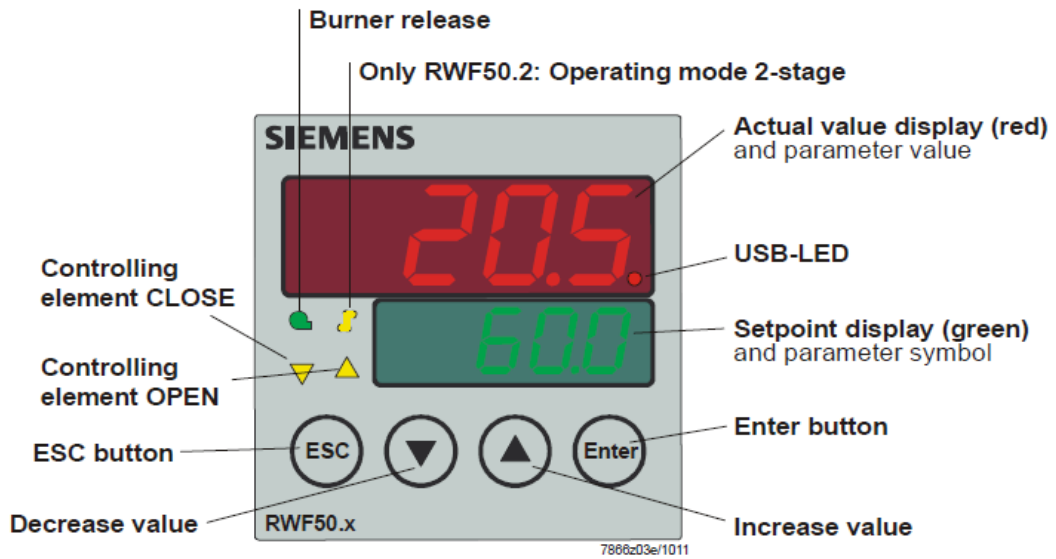

# NAVIGATION MENU

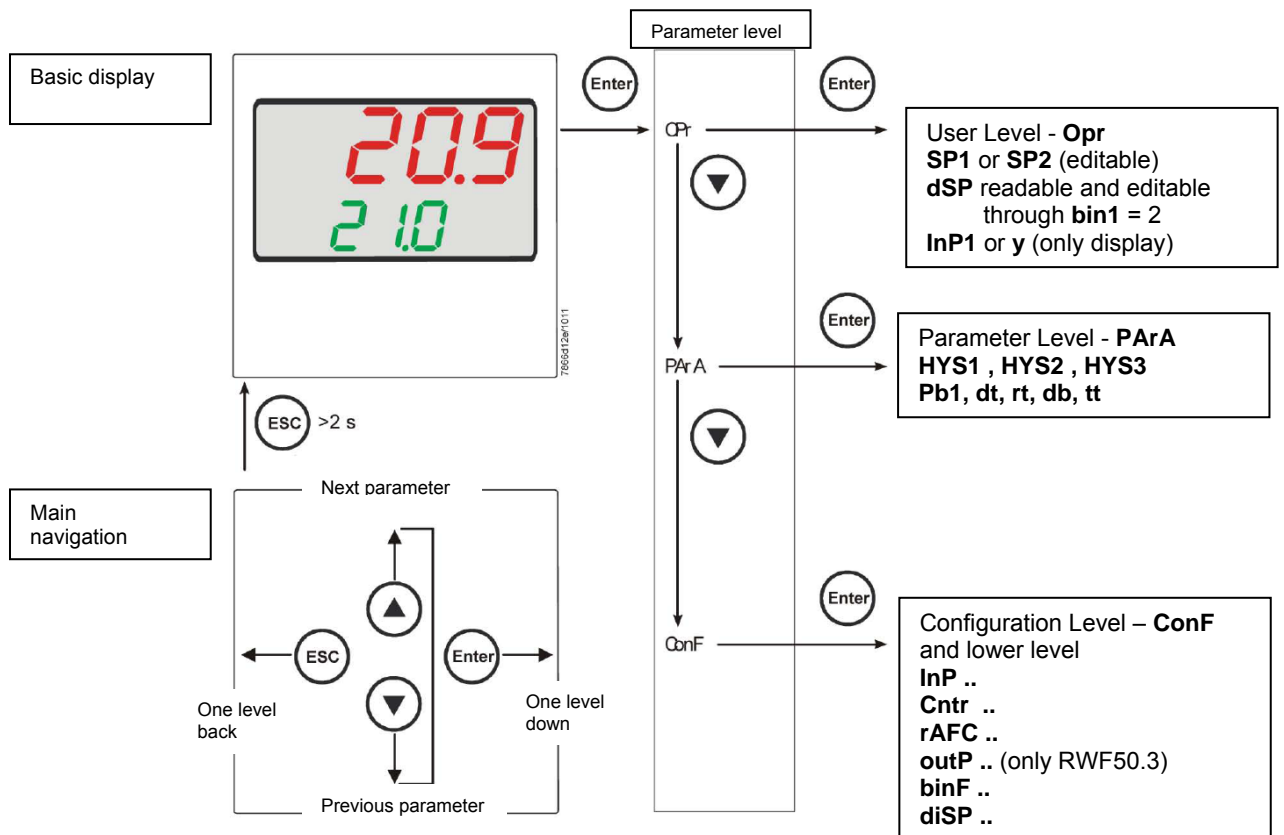

RWF5 is preset good for 90% of applications. However, you can set or edit parameters as follow:

**Set-point: set or modification:**

When the burner is in stand-by, (safety loop open, that is terminals 3-4/T1-T2 on the 7 pole plug open) push the **Enter** button: on the lower display (green) **Opr** appears; push **Enter** again and in the same display **SP1** appears. Push **Enter** again and the lower display (green **SP1**) flashes. Using the **up and down arrows** change the set-point on the upper display (red). Push **Enter** to confirm and push **ESC** more times to get the home position.

**PID parameters set and modifications (see table below):**

- Push **Enter** button, on the green display **Opr** appears; using the **down arrow**, scroll until group **PARA** is reached and push **Enter**.
- on the green display **Pb1** e appears and on the red one the set parameter.
- Push in sequence the **down or up** arrow the menu is scrolled.
- Push **Enter** to select and the **arrows** to choose the desired value. **Enter** to confirm.

Parameter	Display	Range	Factory setting	Remarks
Proportional band	PB.1	1... 9999 digit	10	Typical value for temperature
Derivative action	dt	0... 9999 sec.	80	Typical value for temperature
Integral action	rt	0... 9999 sec.	350	Typical value for temperature
Dead band (*)	db	0... 999,9 digit	1	Typical value
Servocontrol running time	tt	10... 3000 sec.	15	Set servocontrol running time
Switch-on differential (*)	HYS1	0,0... -1999 digit	-5	Value under setpoint below which the burner switches back on (1N-1P closes)
Switch-off differential 2° stage (*)	HYS2	0,0 ... HYS3	3	(enable only with parameter <b>bin1</b> = 4)
Upper switch-off differential (*)	HYS3	0,0... 9999 digit	5	Value over setpoint above which the burner switches off (1N-1P opens)
Switch-on differential on cooling controller (*)	HYS4	0,0... 9999 digit	5	Do not used (enable only with parameter <b>CACT</b> = 0)
Switch-off differential 2° stage on cooling controller (*)	HYS5	HYS6...0,0 digit	5	Do not used (enable only with parameters <b>CACT</b> = 0 and <b>bin1</b> = 4)
Upper switch-off differential on cooling controller (*)	HYS6	0,0... -1999 digit	5	Do not used (enable only with parameter <b>CACT</b> = 0)
Delay modulation	q	0,0... 999,9 digit	0	Do not alter

(\*)Parameters affected by setting of decimal place (**ConF > dISP** parameter **dECP**)

**Setting the kind of sensor to be connected to the device:**

- push the **Enter** button: on the lower display (green) **Opr** appears. Using the **up and down arrows** find **ConF**. Push **Enter** to confirm.
- Now on the green display the group **InP** appears. Push **Enter** and **InP1** is displayed. Enter to confirm.
- You are inside **InP1**; the green display shows **Sen1 (sensor type)**, while the red display shows the chosen sensor code
- Push **Enter** to enter the **Sen1** parameter, then choose the desired sensor using the **arrows**. Push **Enter** to confirm and **ESC** to escape.
- Once selected the sensor, you can modify all the other parameters using **up and down arrows** according to the tables here below.

**ConF > InP > InP1**

Parameter	Value	Description
SEn1 type of sensor for analog input 1	<b>1</b>	<b>Pt100 3 fili</b>
	2	Pt100 2 fili
	3	Pt1000 3 fili
	4	Pt1000 2 fili
	5	Ni1000 3 fili
	6	Ni1000 2 fili
	7	0 ÷ 135 ohm
	15	0 ÷ 20mA
	16	4 ÷ 20mA
	17	0 ÷ 10V
	18	0 ÷ 5V
19	1 ÷ 5V	
OFF1 sensor offset	-1999.. <b>0</b> .. +9999	Using the measured value correction (offset), a measured value can be corrected to a certain degree, either up or down
SCL1 scale low level	-1999.. <b>0</b> .. +9999	In the case of a measuring transducer with standard signal, the physical signal is assigned a display value here (for input ohm, mA, V)
SCH1 scale high level	-1999.. <b>100</b> .. +9999	In the case of a measuring transducer with standard signal, the physical signal is assigned a display value here (for input ohm, mA, V)
dF1 digital filter	0.. <b>0,6</b> ..100	Is used to adapt the digital 2nd order input filter (time in s; 0 s = filter off)
Unit temperature unit	<b>1</b> 2	<b>1 = degrees Celsius</b> 2 = degrees Fahrenheit

(**bold** = factory settings)

**Remark:**

RWF50.2 e RWF50.3 cannot be connected to thermocouples.  
If thermocouples have to be connected, convert the signal to a 4-20 mA one and set the RWF accordingly.

### ConF > Cntr

Parameter	Value	Description
CtYP controller type	<b>1</b> 2	<b>1 = 3-position controller (open-stop-close only RWF50.2)</b> 2 = continuative action controller (only RWF50.3)
CACt control action	<b>1</b> 0	<b>1 = heating controller</b> 0 = cooling controller
SPL least value of the set-point range	-1999.. <b>0</b> ..+9999	set-point limitation prevents entry of values outside the defined range
SPH maximum value of the set-point range	-1999.. <b>100</b> ..+9999	set-point limitation prevents entry of values outside the defined range
oLLo set-point limitation start, operation limit low	<b>-1999</b> .... +9999	lower working range limit
oLHi set-point limitation end, operation limit high	-1999.... <b>+9999</b>	upper working range limit

(**bold** = factory settings)

### ConF > rAFC

#### Activation boiler shock termic protetion:

RWF50.. can activate the thermal shock protection only on sites where the set-point is lower than 250°C and according to **rAL** parameter.

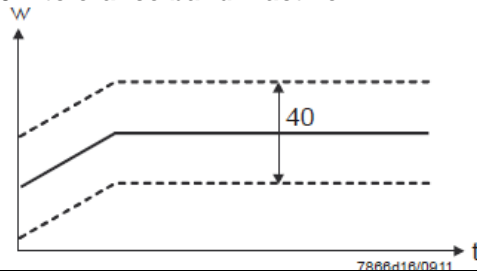
Parameter	Value	Description
FnCT function	<b>0</b> 1 2	Choose type of range degrees/time <b>0 = deactivated</b> 1 = Kelvin degrees/minute 2 = Kelvin degrees/hour
rASL ramp rate	<b>0,0</b> ... 999,9	Slope of thermal shock protection (only with functions 1 and 2)
toLP tolerance band ramp	<b>0</b> ...9999	width of tolerance band (in K) about the set-point <b>0 = tolerance band inactive</b> 
rAL ramp limit	<b>0</b> ...250	Ramp limit. When this value is lower than the temperature set-point, the RWF controls the output increasing the temp set point step by step according to rASL. If this is over the temp set point, the control is performed in cooling.

(**bold** = factory settings)

### ConF > OutP (parameter under group only for RWF50.3)

Parameter	Value	Description
FnCt tipo di controllo	1 <b>4</b>	1 = analog input 1 doubling with possibility to convert (depending on par <b>SiGn</b> ) <b>4 = modulation controller</b>
SiGn type of output signal	<b>0</b> 1 2	physical output signal (terminals A+, A-) <b>0 = 0÷20mA</b> 1 = 4÷20mA 2 = 0÷10V
rOut Value when out of input range	<b>0...101</b>	signal (in percent) when measurement range is crossed
oPnt zero point	-1999... <b>0</b> ..+9999	value range of the output variable is assigned to a physical output signal Per default, the setting corresponds to 0...100% angular positioning for the controller outputs (terminals A+, A-) (effective only with <b>FnCt = 1</b> )
End End value	-1999... <b>100</b> ..+9999	value range of the output variable is assigned to a physical output signal Per default, the setting corresponds to 0...100% angular positioning for the controller outputs (terminals A+, A-) (effective only with <b>FnCt = 1</b> )

(**bold** = factory settings)

### ConF > binF

Parameter	Value	Description
bin1 digital inputs (terminals DG - D1)	<b>0</b> 1 2 4	<b>0 = without function</b> 1 = set-point changeover (SP1 / SP2) 2 = set-point shift ( <b>Opr</b> > <b>dSP</b> parameter = value of set-point modify) 4 = changeover of operating mode open – modulating operation; close – 2 stage operation.

(**bold** = factory settings)

### ConF > dISP

Parameter	Value	Description
diSU upper display (red)	0 <b>1</b> 4 6 7	display value for upper display: 0 = display power-off <b>1 = analog input value</b> 4 = Controller's angular positioning 6 = set-point value 7 = end value with thermal shock protection
diSL lower display (green)	0 1 4 <b>6</b> 7	display value for lower display: 0 = display power-off 1 = analog input value 4 = Controller's angular positioning <b>6 = set-point value</b> 7 = end value with thermal shock protection
tout timeout	0.. <b>180</b> ..250	time (s) on completion of which the controller returns automatically to the basic display, if no button is pressed
dECP decimal point	<b>0</b> 1 2	<b>0 = no decimal place</b> 1 = one decimal place 2 = two decimal places
CodE level lockout	<b>0</b> 1 2 3	<b>0 = no lockout</b> 1 = configuration level lockout (ConF) 2 = Parameter and configuration level lockout (PARa & ConF) 3 = keyboard lockout

(**bold** = factory settings)

**Manual control :**

- in order to manual change the burner load, while firing keep pushing the **ESC** button for more than 5 s; on the lower green display **Hand** appears.
- using the **UP** and **DOWN** arrows, the load varies.
- Keep pushing the **ESC** button for getting the normal operation again.
- **NB:** every time the device shuts the burner down (start led switched off - contact 1N-1P open), the manual control is not active.

**Device self-setting (auto-tuning):**

If the burner in the steady state does not respond properly to heat generator requests, you can activate the Device's self-setting function, which recalculates PID values for its operation, deciding which are most suitable for the specific kind of request

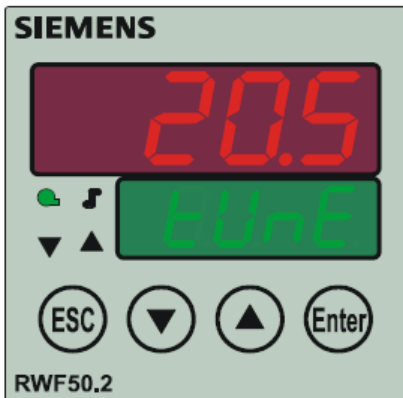

Follow the below instructions:  
push the **UP** and **DOWN** arrows for more than 5 s; on the green lower display **TUNE** appears. Now the device pushes the burner to increase and decrease its output. During this time, the device calculates PID parameters (**Pb1**, **dt** and **rt**). After the calculations, the TUNE is automatically deactivated and the device has already stored them.  
In order to stop the Auto-tuning function while it works, push again the **UP** and **DOWN** arrows for more than 5 s. The calculated PID parameters can be manually modified following the previously described instructions.

**Display of software version :**



The software version is shown by pushing **Enter + UP arrow** on the upper display

**Electric connection :**

With 7 pins connector version

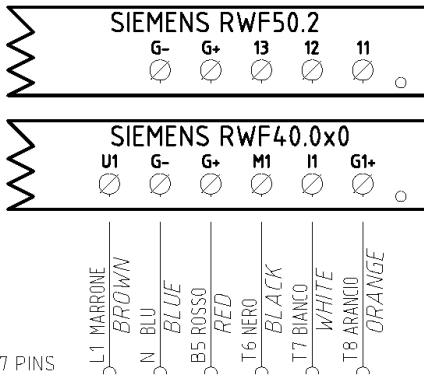

CONN. 7 PINS

With terminals version

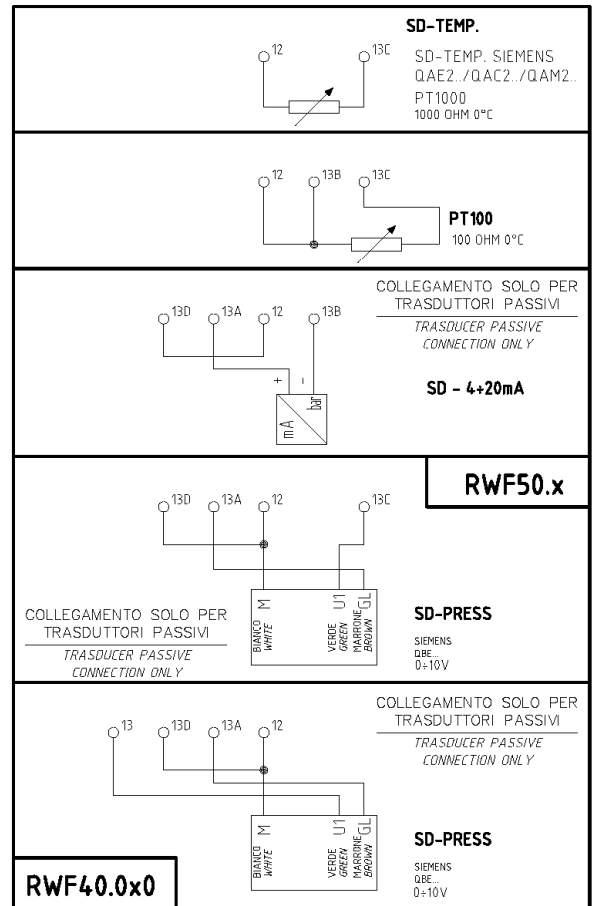
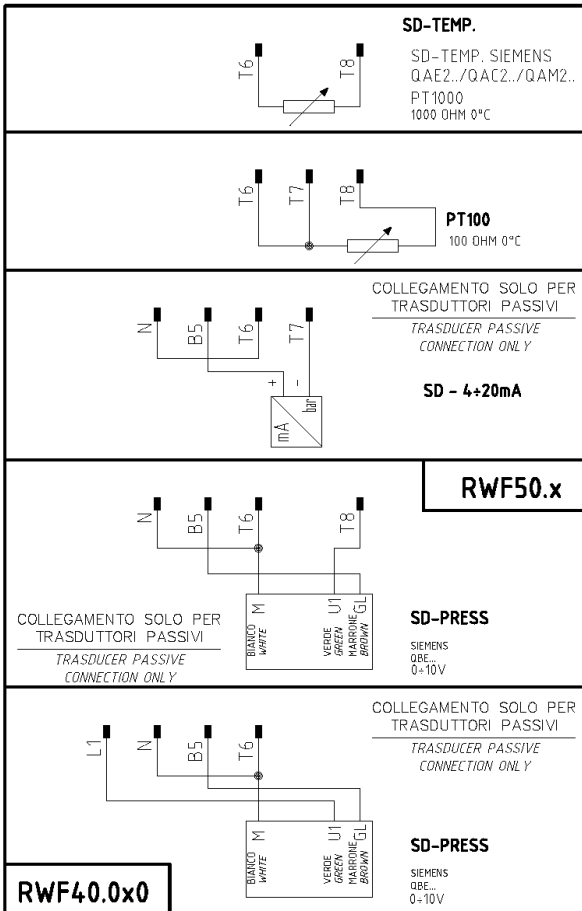
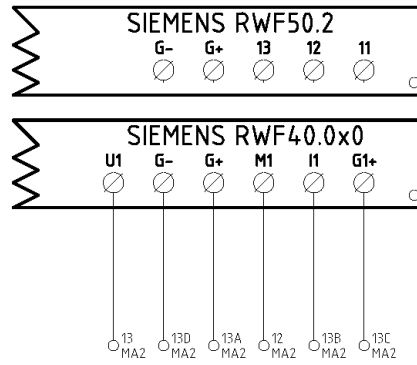

Matches terminals between RWF50.2 and RWF40.0x0

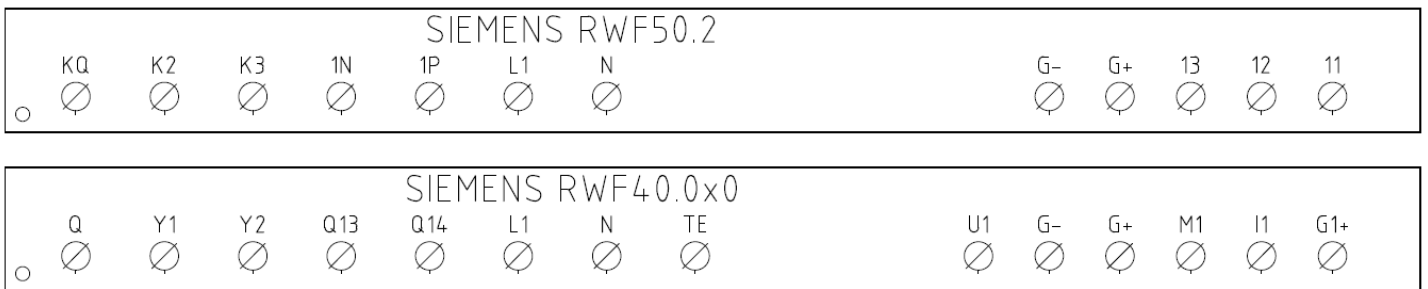

Parameters summarising for RWF50.2x:

Navigation menù	Conf Inp					Conf			PArA					Opr	
	Inp1					Cntr		diSP							
Types of probe	SEn1	OFF1	SCL	SCH	Unit	SPL	SPH	dECP	Pb. 1	dt	rt	tt	HYS1 (*)	HYS3 (*)	SP1 (*)
Siemens QAE2120...	6	0	needless	needless	1	30	95	1	10	80	350 (#)		-5	5	80 °C
Siemens QAM2120..	6	0	needless	needless	1	0	80	1	10	80	350 (#)		-2.5	2.5	40°C
Pt1000 (130°C max.)	4	0	needless	needless	1	30	95	1	10	80	350 (#)		-5	5	80°C
Pt1000 (350°C max.)	4	0	needless	needless	1	0	350	1	10	80	350 (#)		-5	10	80°C
Pt100 (130°C max.)	1	0	needless	needless	1	0	95	1	10	80	350 (#)		-5	5	80°C
Pt100 (350°C max)	1	0	needless	needless	1	0	350	1	10	80	350 (#)		-5	10	80°C
Sonda 4÷20mA / 0÷1,6bar	16	0	0	160	needless	0	160	0	5	20	80 (#)		0	20	100 kPa
Sonda 4÷20mA / 0÷10bar	16	0	0	1000	needless	0	1000	0	5	20	80 (#)		0	50	600 kPa
Sonda 4÷20mA / 0÷16bar	16	0	0	1600	needless	0	1600	0	5	20	80 (#)		0	80	600 kPa
Sonda 4÷20mA / 0÷25bar	16	0	0	2500	needless	0	2500	0	5	20	80 (#)		0	125	600 kPa
Sonda 4÷20mA / 0÷40bar	16	0	0	4000	needless	0	4000	0	5	20	80 (#)		0	200	600 kPa
Sonda 4÷20mA / 0÷60PSI	16	0	0	600	needless	0	600	0	5	20	80 (#)		0	30	300 (30PSI)
Sonda 4÷20mA / 0÷200PSI	16	0	0	2000	needless	0	2000	0	5	20	80 (#)		0	75	600 (60PSI)
Sonda 4÷20mA / 0÷300PSI	16	0	0	3000	needless	0	3000	0	5	20	80 (#)		0	120	600 (60PSI)
Siemens QBE2002 P4	17	0	0	400	needless	0	400	0	5	20	80 (#)		0	20	200 kPa
Siemens QBE2002 P10	17	0	0	1000	needless	0	1000	0	5	20	80 (#)		0	50	600 kPa
Siemens QBE2002 P16	17	0	0	1600	needless	0	1600	0	5	20	80 (#)		0	80	600 kPa
Siemens QBE2002 P25	17	0	0	2500	needless	0	2500	0	5	20	80 (#)		0	125	600 kPa
Siemens QBE2002 P40	17	0	0	4000	needless	0	4000	0	5	20	80 (#)		0	200	600 kPa
Segnale 0÷10V	17	0	to be fixed	to be fixed	needless	to be fixed	to be fixed	to be fixed	5	20	80 (#)		to be fixed	to be fixed	to be fixed
Segnale 4÷20mA	16	0	to be fixed	to be fixed	needless	to be fixed	to be fixed	to be fixed	5	20	80 (#)		to be fixed	to be fixed	to be fixed

NOTE : (#) tt - Types of probe

SQL33 ; STM30; SQM10; SQM40; SQM50; SQM54 = 30 (second) - STA12B3.41; SQN30.251; SQN72.4A4A20 = 12 (second)

(\*) These values are factory set - values **MUST BE** set during operation at the plant based on the real working temperature/pressure value.

**WARNING :** With pressure probes the parameters SP1, SCH, SCL, HYS1, HYS3 must be selected, and visualized in kPa (kilo Pascal). (1bar = 100.000Pa = 100kPa).

**TABLE OF PARAMETERS TO BE MODIFIED FOR CALIBRATIONS RWF50.3x/RWF55.xx (CONTINUOUS OUTPUT 4÷20mA) INSTEAD OF 3 POINTS**

Navigation menù	Conf OutP				
Parameter	FnCt	SiGn	rOut	OPnt	End
	4	1 (4÷20mA)	0	0	100

NOTE : (#) tt - servocontrol travel time

SQL33 ; STM30; SQM10; SQM40; SQM50; SQM54 = 30 (second)

STA12B3.41; SQN30.251; SQN72.4A4A20 = 12 (second)

(\*) Factory-set values, these values must be varied according to the actual working temperature/pressure of the system.

**WARNING :** With pressure probes in bar, parameters SP1, SCH, SCL, HYS1, HYS3 must be set, and displayed in kPa (kilo Pascal); 1bar = 100,000Pa = 100kPa.  
With pressure probes in PSI the parameters SP1, SCH, SCL, HYS1, HYS3 must be set, and displayed in PSI x10 (example : 150PSI > display 1500).

## APPENDIX: PROBES CONNECTION

To assure the utmost comfort, the control system needs reliable information, which can be obtained provided the sensors have been installed correctly. Sensors measure and transmit all variations encountered at their location.

Measurement is taken based on design features (time constant) and according to specific operating conditions. With wiring run in raceways, the sheath (or pipe) containing the wires must be plugged at the sensor's terminal board so that currents of air cannot affect the sensor's measurements.

### Ambient probes (or ambient thermostats)

#### Installation

The sensors (or room thermostats) must be located in reference rooms in a position where they can take real temperature measurements without being affected by foreign factors.

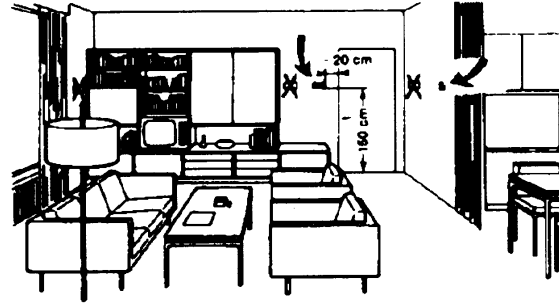
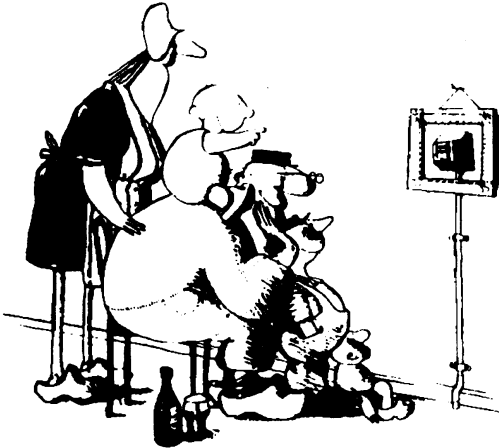

### Outside probes (weather)

#### Installation

In heating or air-conditioning systems featuring adjustment in response to outside temperature, the sensor's positioning is of paramount importance.

### It's good to be admired ...even better to be effective

Heating systems: the room sensor must not be installed in rooms with heating units complete with thermostatic valves. Avoid all sources of heat foreign to the system.

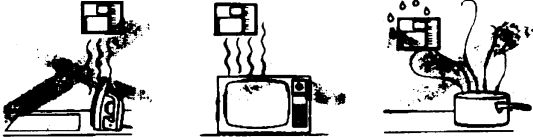

**General rule:** on the outer wall of the building where the living rooms are, never on the south-facing wall or in a position where they will be affected by morning sun. If in any doubt, place them on the north or north-east façade.

### Location

On an inner wall on the other side of the room to heating units height above floor 1.5 m, at least 1.5 m away from external sources of heat (or cold).

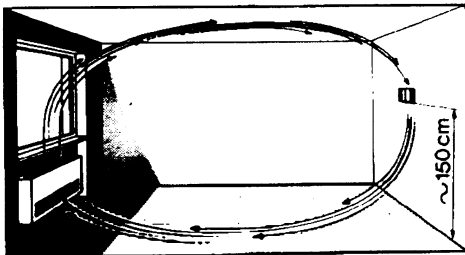

### Installation position to be avoided

near shelving or alcoves and recesses, near doors or windows, inside outer walls exposed to solar radiation or currents of cold air, on inner walls with heating system pipes, domestic hot water pipes, or cooling system pipes running through them.

### Positions to be avoided

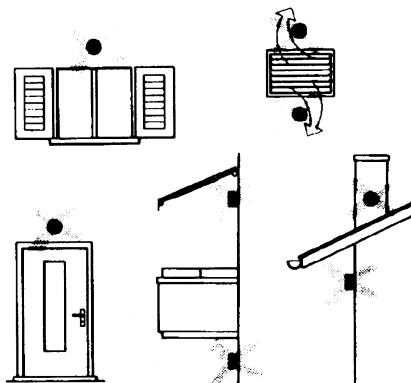

Avoid installing near windows, vents, outside the boiler room, on chimney breasts or where they are protected by balconies, cantilever roofs.

**The sensor must not be painted (measurement error).**

## Duct or pipe sensors

### Installing temperature sensors

For measuring outlet air:

- after delivery fan or
- after coil to be controlled, at a distance of at least 0,5 m

For measuring room temperature:

- before return air intake fan and near room's return airintake. For measuring saturation temperature: after mist eliminator.

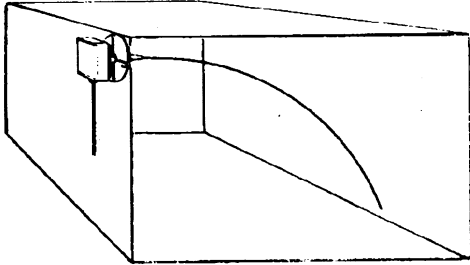

Bend 0.4m sensor by hand (never use tools) as illustrated.

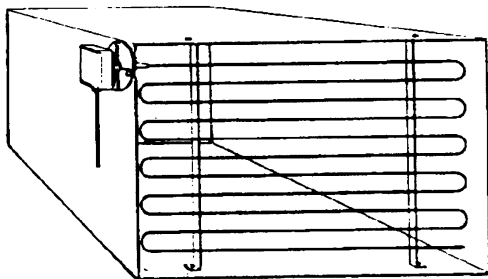

Use whole cross-section of duct, min. distance from walls 50 mm, radius of curvature 10 mm for 2m or 6m sensors.

### Installing combined humidity sensors

As max. humidity limit sensor on outlet (steam humidifiers).

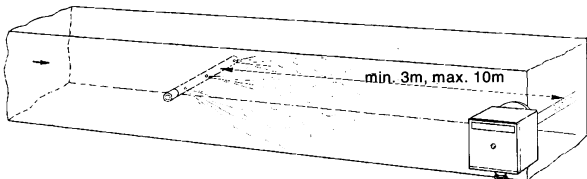

### Installing pressure sensors

A - installation on ducts carrying fluids at max. temperature 80°C

B - installation on ducts at temperature over 80°C and for refrigerants

C - installation on ducts at high temperatures:

- increase length of siphon
- place sensor at side to prevent it being hit by hot air coming from the pipe.

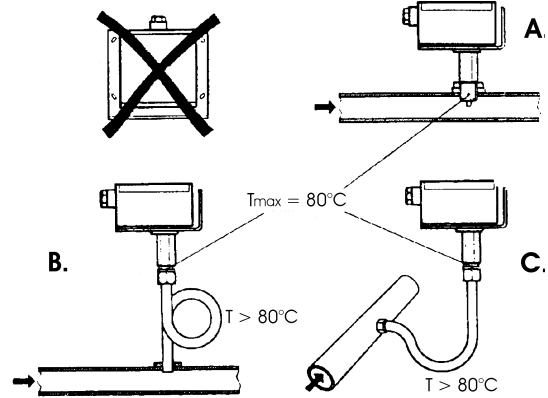

### Installing differential pressure sensors for water

- Installation with casing facing down not allowed.-With temperature over 80°C, siphons are needed.
- To avoid damaging the sensor, you must comply with the following instructions

#### when installing:

- make sure pressure difference is not greater than the value permitted by the sensor
- when there are high static pressures, make sure you insert shutoff valves A-B-C.

### Putting into operation

Start disable

1=open C1=open C

2=open A2=close B

3=open B3=close A

4= close C

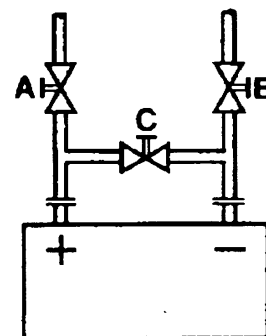

**Immersion or strap-on sensors**

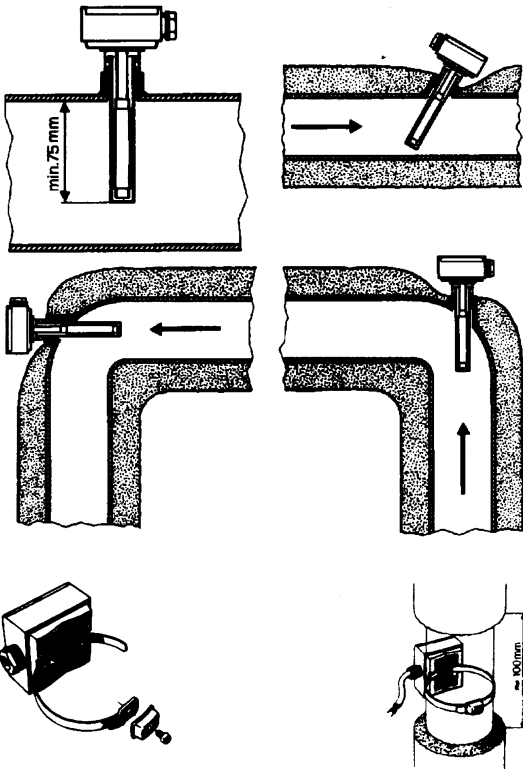

**Immersion probes installation**

Sensors must be installed on the stretch of pipe in which fluid circulates all the time.

The rigid stem (sensing element doing the measuring) must be inserted by at least 75mm and must face the direction of flow.

Recommended locations: on a bend or on a straight stretch of pipe but tilted by 45° and against the flow of fluid.

Protect them to prevent water from infiltrating (dripping gates, condensation from pipes etc.)

**Installing QAD2.. strap-on sensors**

Make sure fluid is circulating in the chosen location.

Eliminate insulation and paintwork (including rust inhibitor) on a min. 100mm length of pipe.

Sensors come with straps for pipes up to 100 mm in diameter

**Placing the probes (QAD22.../QAE21.../QAP21.../RCA...)**

**With pumps on outlet**

with 3 ways valves / with 4 ways valves



Panel system / burner control

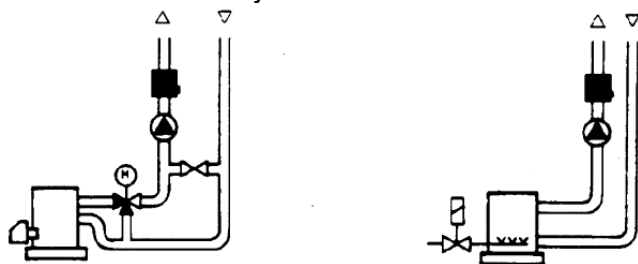

**With pumps on return**

with 3 ways valves / with 4 ways valves



**Strap-on or immersion sensors?**

**QAD2.. strap-on sensors**

Advantages :

- 10 sec. time constant
- Installed with system running (no plumbing work)
- Installation can be changed easily if it proves incorrect.

Limits:

- Suitable for pipe diameters max. 100 mm
- Can be affected by currents of air etc.

**QAE2... immersion sensors**

Advantages:

- Measure "mean" fluid temperature
- No external influence on measurement such as: currents of air, nearby pipes etc.

Limits:

- Time constant with sheath: 20 sec.
- Hard to change installation position if it proves incorrect.

Duct pressure switches and sensors

Installing differential pressure probes for air

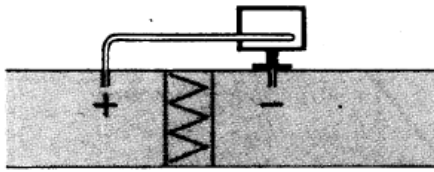

A - Control a filter (clogging)

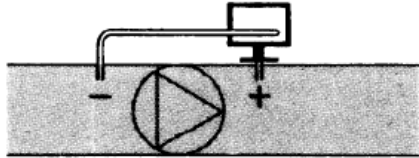

B - Control a fan (upstream/downstream)

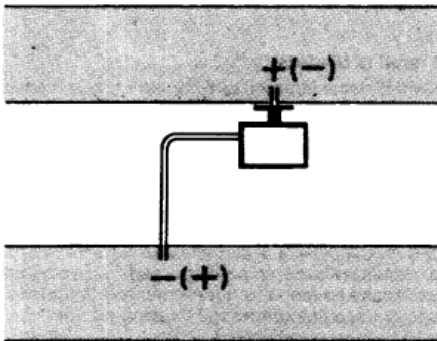

C - Measurement of difference in pressure between two ducts

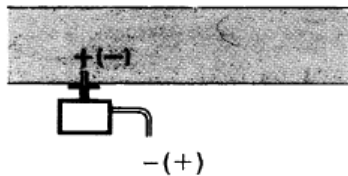

D - Measurement of difference in pressure between two rooms or of inside of duct and outside

Basic principles

Measuring static pressure (i.e. pressure exerted by air on pipe walls)

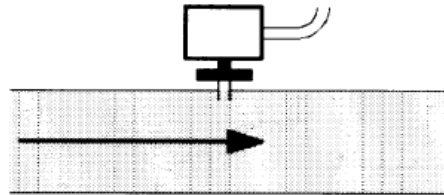

Measuring dynamic pressure

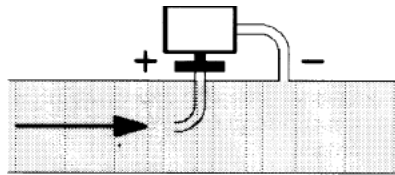

$$Pd = \frac{\gamma v^2}{2g}$$

Key

- $\gamma$  Kg/m<sup>3</sup>, specific weight of air
- $v$  m/s, air speed
- $g$  9.81 m/s<sup>2</sup> gravity acceleration
- Pd mm C.A., dynamic pressure

Measuring total pressure

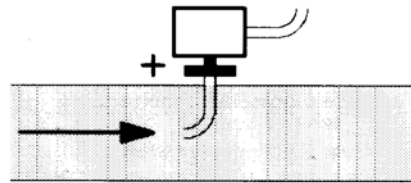

## Spare parts

Description	Code
Modulator RWF50.2 (uscita a 3 punti - apri, fermo, chiudi) 2570148	2570148
Modulator RWF50.3 (uscita continua 0÷20mA, 4÷20mA, 0÷10V) 2570149	2570149
Temperature probe Siemens QAE2120.010A (30÷130°C) 2560101	2560101
Temperature probe Siemens QAM2120.040 (-15÷+50°C) 2560135	2560135
Thermoresistor Pt1000 ø6mm L100mm (30÷130°C) 2560188	2560188
Thermoresistor Pt1000 ø10mm L200mm (0÷350°C) 2560103	2560103
Thermoresistor Pt100 ø10mm L200mm (0÷350°C) 2560145	2560145
Thermoresistor Pt100 ø8mm L85mm (0÷120°C) 25601C3	25601C3
Pressure probe Siemens QBE2.. P4 (0÷4bar) 2560159	2560159
Pressure probe Siemens QBE2.. P10 (0÷10bar / signal 0÷10V) 2560160	2560160
Pressure probe Siemens QBE2.. P16 (0÷16bar / signal 0÷10V) 2560167	2560167
Pressure probe Siemens QBE2.. P25 (0÷25bar / signal 0÷10V) 2560161	2560161
Pressure probe Siemens QBE2.. P40 (0÷40bar / signal 0÷10V) 2560162	2560162
Pressure probe Danfoss MBS 3200 P 1,6 (0÷1,6bar / signal 4÷20mA) 2560189	2560189
Pressure probe Danfoss MBS 3200 P 10 (0÷10bar / signal 4÷20mA) 2560190	2560190
Pressure probe Danfoss MBS 3200 P 16 (0÷16bar / signal 4÷20mA) 2560191	2560191
Pressure probe Danfoss MBS 3200 P 25 (0÷25bar / signal 4÷20mA) 2560192	2560192
Pressure probe Danfoss MBS 3200 P 40 (0÷40bar / signal 4÷20mA) 2560193	2560193
Pressure probe Siemens 7MF1565-3BB00-1AA1 (0÷1,6bar / signal 4÷20mA) 25601A3	25601A3
Pressure probe Siemens 7MF1565-3CA00-1AA1 (0÷10bar / signal 4÷20mA) 25601A4	25601A4
Sonda di pressione Siemens 7MF1565-3CB00-1AA1 (0÷16bar / signal 25601A5	25601A5
Pressure probe Siemens 7MF1565-3CD00-1AA1 (0÷25bar / signal 4÷20mA) 25601A6	25601A6
Pressure probe Siemens 7MF1565-3CE00-1AA1 (0÷40bar / signal 4÷20mA) 25601A7	25601A7
Pressure probe Gefran E3E B1V6 MV (0÷1,6bar / segnale 4÷20mA) 25601C4	25601C4
Pressure probe Danfoss E3E B01D MV (0÷10bar / segnale 4÷20mA) 25601C5	25601C5
Pressure probe Danfoss E3E B16U MV (0÷16bar / segnale 4÷20mA) 25601C6	25601C6
Pressure probe Danfoss E3E B25U MV (0÷25bar / segnale 4÷20mA) 25601C7	25601C7
Pressure probe Danfoss E3E B04D MV (0÷40bar / segnale 4÷20mA) 25601C8	25601C8
Pressure probe Siemens 7MF1567-4CD00-1EA1 (0-300PSI 1/4NPT 4-20mA)	25601G0
Pressure probe Siemens 7MF1567-4BF00-1EA1 (0-60PSI 1/4NPT 4-20mA)	25601G1
Pressure probe Siemens 7MF1567-4CB00-1EA1 (0-200PSI 1/4NPT 4-20mA)	25601G2

Note: Specifications and data subject to change. Errors and omissions excepted.

# **KM3 Modulator**

**USER MANUAL**

## MOUNTING

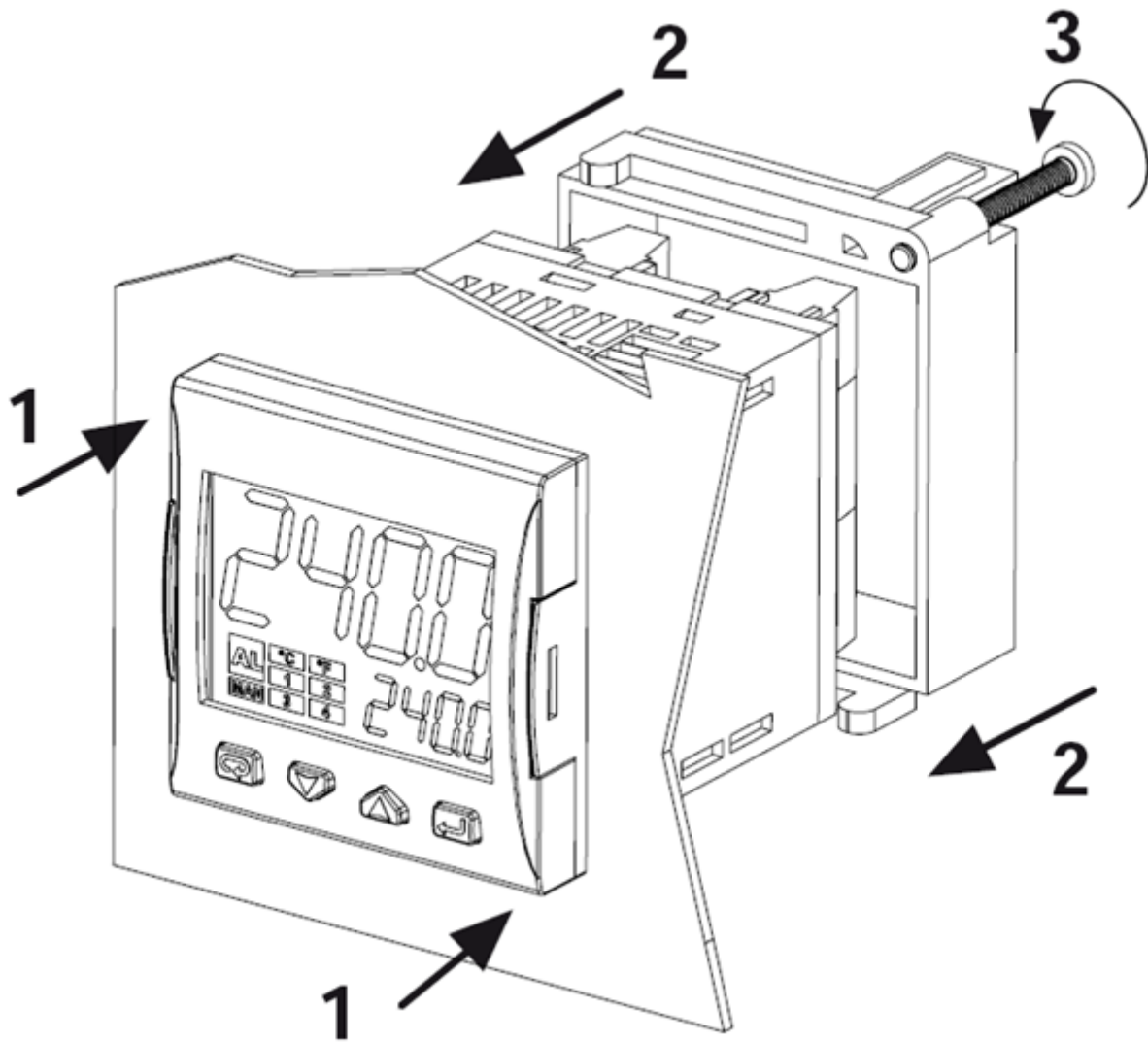

**DISPLAY AND KEYS**

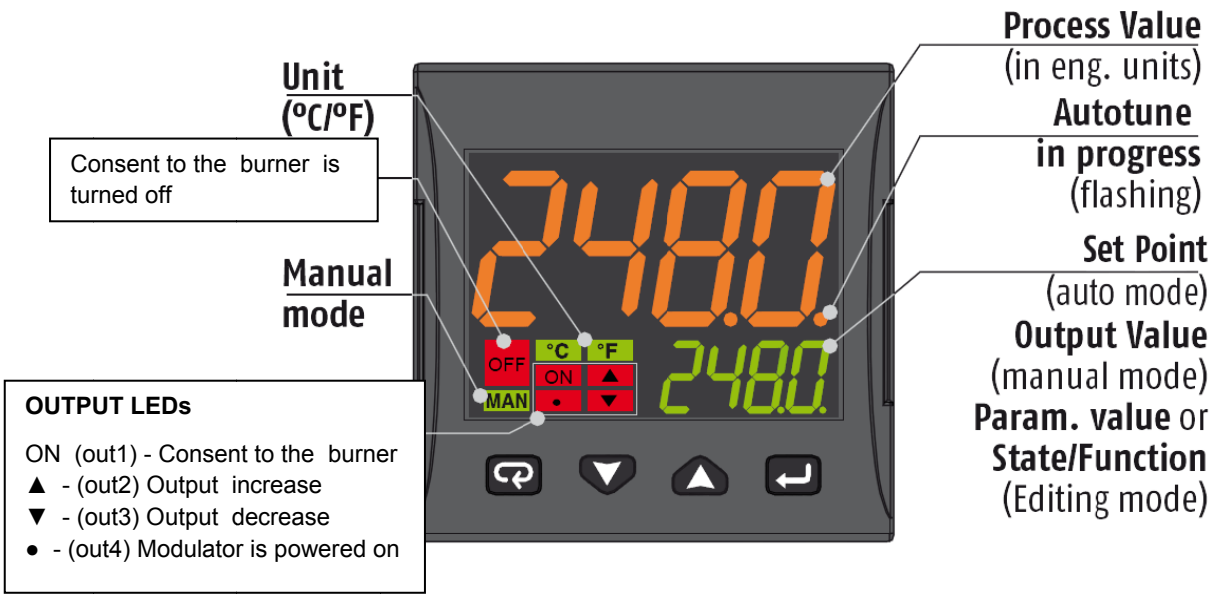

	<b>Operator Mode</b>	<b>Editing Mode</b>
	Access to: - Operator Commands (Timer, Setpoint selection ...) - Parameters - Configuration	Confirm and go to Next parameter
	Access to: - Operator additional information (Output value, running time ...)	Increase the displayed value or select the next element of the parameters list
	Access to: - Set Point	Decrease the displayed value or select the previous element
	Programmable key: Start the programmed function (Autotune, Auto/Man, Timer ...)	Exit from Operator commands/Parameter setting/Configuration

## CONNECTIONS DIAGRAM

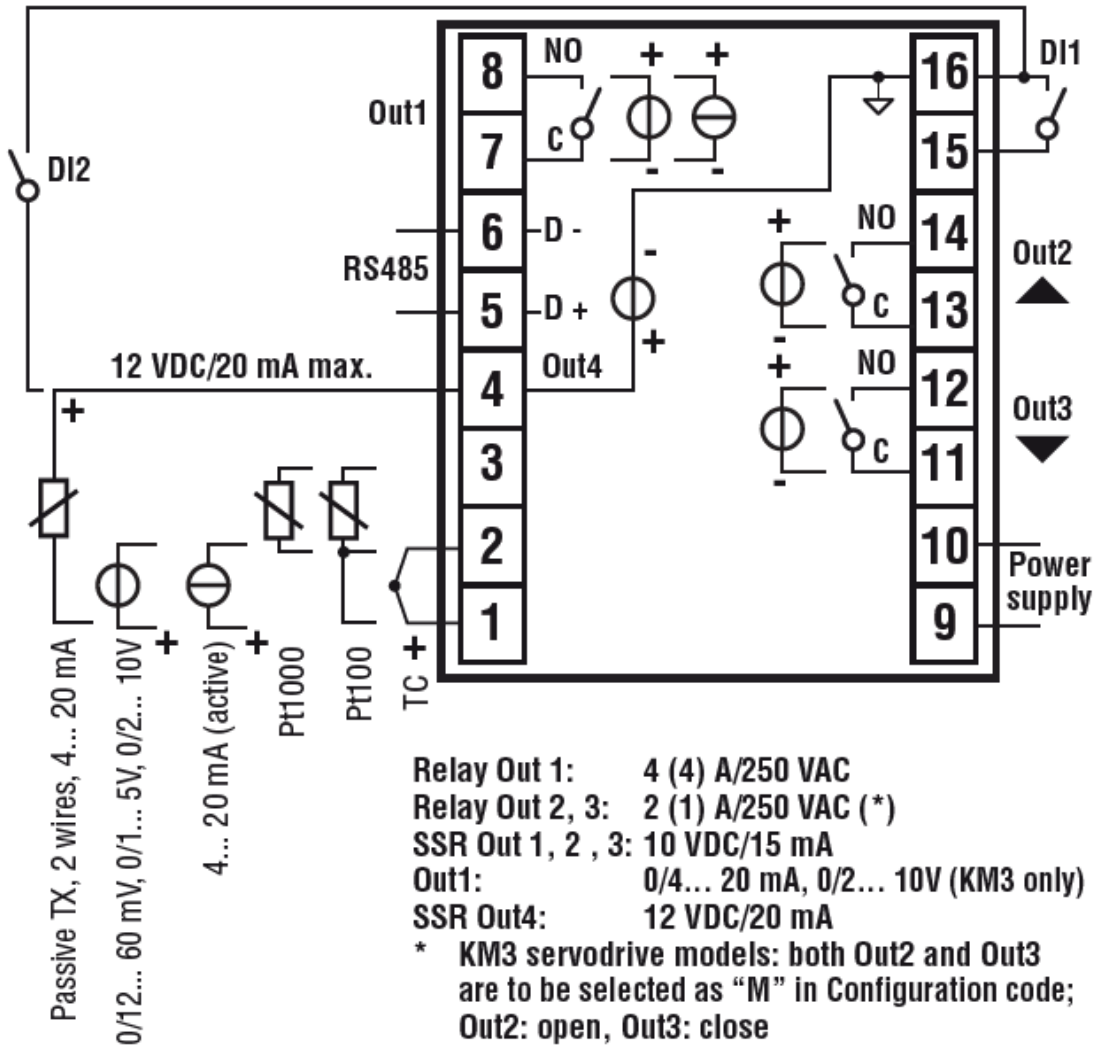

### Probe connection:

- **PT1000/NTC/PTC:** between terminal 3 and 2
- **PT 100:** between terminal 3 and 2 with terminal 1
- **Passive pressure probe 0/4-20 mA:** between terminal 4 (+) e 1 (-)  
Note: out4 must be activated ( IO4F must be setted to ON )
- **Powered pressure probe 0/4-20 mA** between terminal 4 (power supply), 2 ( negative) e 1 (positive)  
Note: set IO4F to ON to activate Out4

### Power supply connection:

- **Neutral wire:** terminal 9
- **Phase:** terminal 10 ( 100...240 Vac )
- Close terminals 15-16 to switch to the set point 2

### Output connection:

- **Channel 1:** terminal 7 and 8 ( burner on – off )
- **Channel 2:** terminal 11 and 12 (servomotor opens)
- **Channel 3:** terminal 13 and 14 (servomotor closes)

## SETPOINT AND HYSTERESIS CONFIGURATION (SP, AL1, HAL1 parameters)

Push the  button to enter into the setpoint configuration:

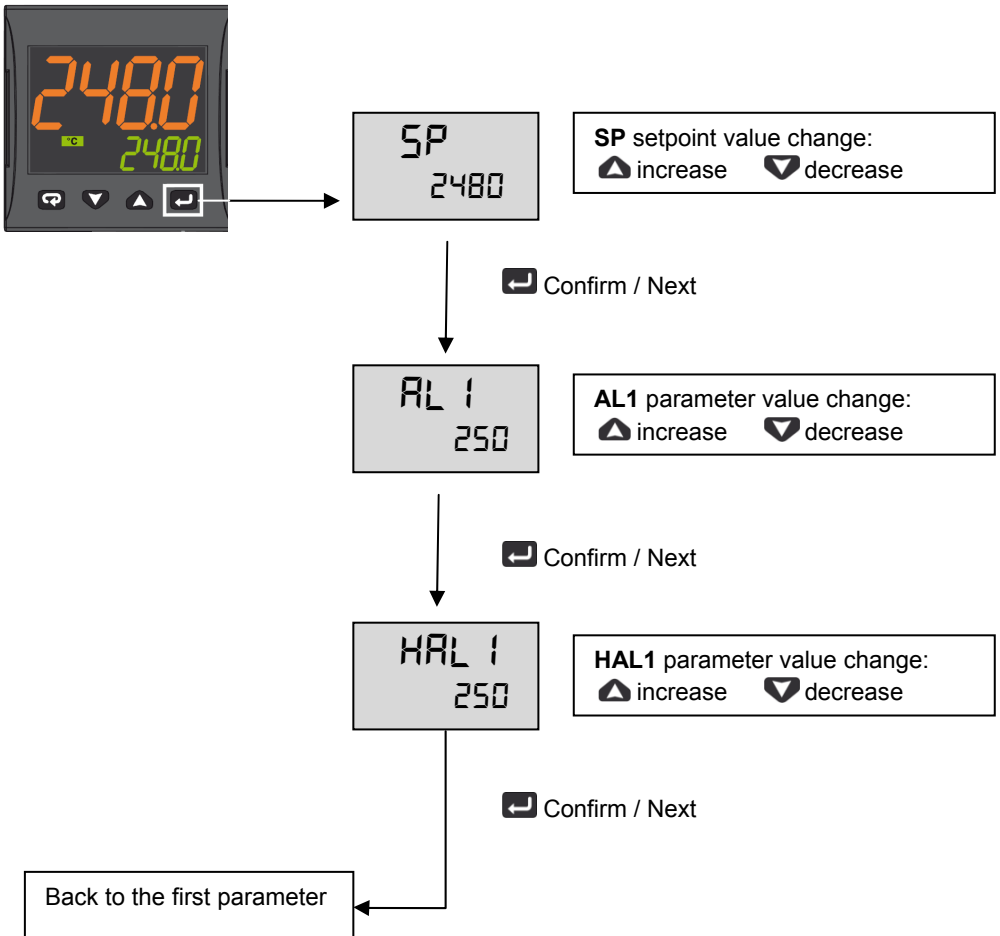

To return to normal mode, press the  key for 3 seconds or wait the 10s timeout

### Operation example

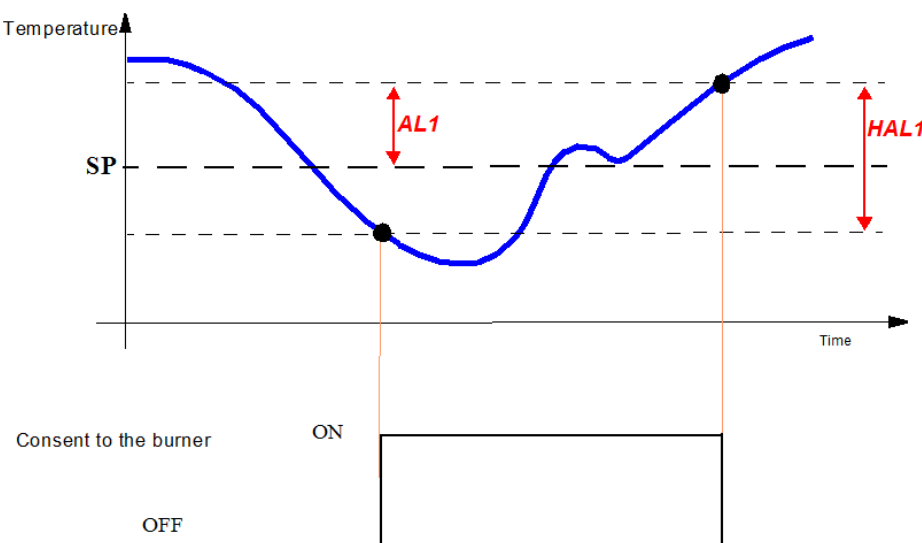

## LIMITED ACCESS LEVEL

Proceed as follows to change some parameters that are not visible in standard user mode:

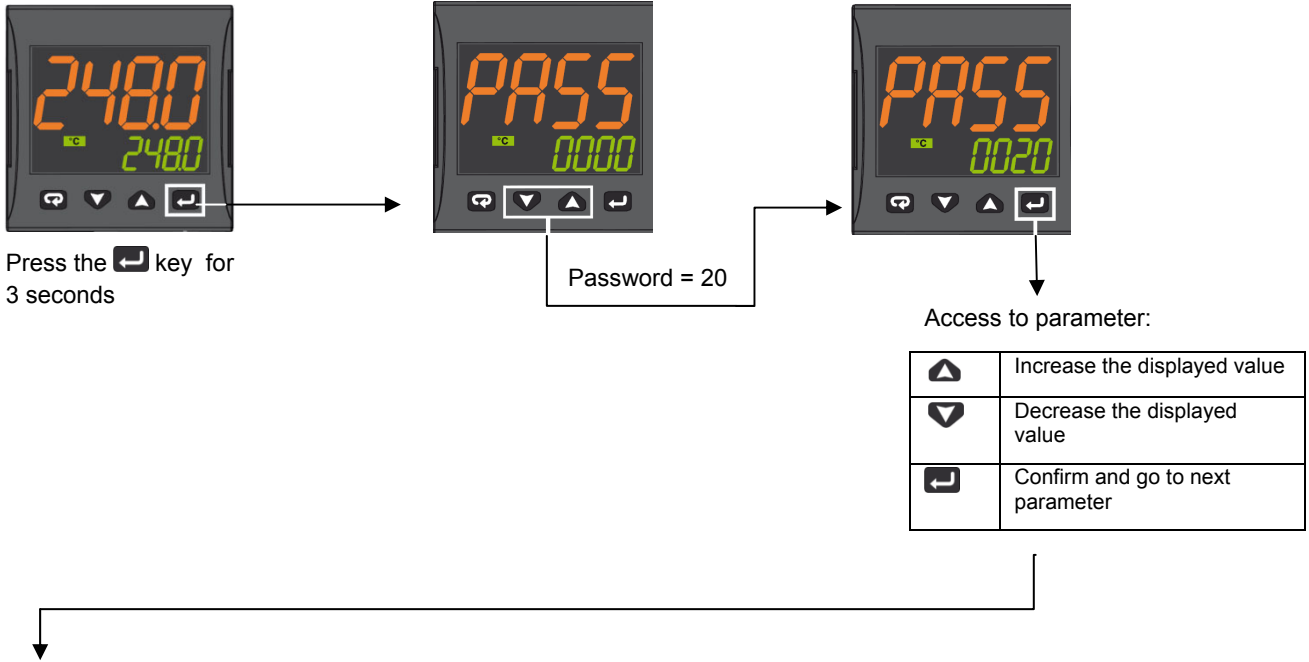

Param	Description	Values	Default
SEnS	Input type	Pt1 = RTD Pt100 Pt10 = RTD Pt1000 0.20 = 0..20mA 4.20 = 4..20mA Pressure probe 0.10 = 0..10V 2.10 = 2..10V crAL= Thermocouple K	Depends on the probe
SP	Set point 1	SPLL ... SPLH	See page 7
AL1	AL1 threshold	AL1L... AL1H (E.U.)	
HAL1	AL1 hysteresis	1... 9999 (E.U.)	
Pb	Proportional band	1... 9999 (E.U.)	
ti	Integral time	0 (oFF) ... 9999 (s)	
td	Derivative time	0 (oFF) ... 9999 (s)	
Str.t	Servomotor stroke time	5...1000 seconds	
db.S	Servomotor dead band	0...100%	
SPLL	Minimum set point value	-1999 ... SPLH	
SPLH	Maximum set point value	SPLL ... 9999	
dp	Decimal point position	0... 3	
SP 2	Set point 2	SPLL...SPLH	60
A.SP	Selection of the active set point	"SP" ... "nSP"	SP

To exit the parameter setting procedure press the key (for 3 s) or wait until the timeout expiration (about 30 seconds)

### Probe parameters configuration MODULATORE ASCON KM3

Parameter Group	inP				AL1				rEG				SP			
	Sens	dp	SSC	FSc	unit	IO4.F (**)	AL1 (***)	HAL1 (***)	Pb (***)	ti (***)	td (***)	Str.t	db.S	SPLL	SPHL	SP (***)
Probes		Dec Point	Scale Min	Scale Max			Off	On	p	i	d	servo time s	Band Mo.	SP Min	SP Max	Set point
Pt1000 (130°C max)	Pt10	1			°C	on	5	10	10	350	1	*	5	30	95	80
Pt1000 (350°C max)	PT10	1			°C	on	10	10	10	350	1	*	5	0	350	80
Pt100 (130°C max)	PT1	1			°C	on	5	10	10	350	1	*	5	0	95	80
Pt100 (350°C max)	Pt1	1			°C	on	10	10	10	350	1	*	5	0	350	80
Pt100 (0÷100°C 4÷20mA)	4.20	1	0	100		on	5	10	10	350	1	*	5	0	95	80
Thermocouple K (1200°C max)	crAL	0			°C	on	20	25	10	350	1	*	5	0	1200	80
Thermocouple J (1000°C max)	J	0			°C	on	20	25	10	350	1	*	5	0	1000	80
4-20mA / 0-1,6bar Pressure probe	4.20	0	0	160		on	20	20	5	120	1	*	5	0	160	100
4-20mA / 0-10bar Pressure probe	4.20	0	0	1000		on	50	50	5	120	1	*	5	0	1000	600
4-20mA / 0-16bar Pressure probe	4.20	0	0	1600		on	80	80	5	120	1	*	5	0	1600	600
4-20mA / 0-25bar Pressure probe	4.20	0	0	2500		on	125	125	5	120	1	*	5	0	2500	600
4-20mA / 0-40bar Pressure probe	4.20	0	0	4000		on	200	200	5	120	1	*	5	0	4000	600
QBE2002 / 0-25bar Pressure probe	0.10	0	0	2500		0n	125	125	5	120	1	*	5	0	2500	600

Note:

(\*) Str.t - Servomotor stroke time

SQL33; STM30; SQM10; SQM40; SQM50; SQM54 = 30 (Seconds)

STA12B3.41; SQN30.251; SQN72.4A4A20 = 12 (Seconds)

**(\*\*) Out 4 ... on Display led °4 must be switched on, otherwise change the io4.F parameter value from "on" to "out4", confirm the value, quit the configuration mode then change again the io4.F parameter value from "out4" to "on".**







(\*\*\*) Factory settings. These values must be adapted to machine conditions

N.B. For pressure probe, SP, SPHL, SPLL parameters values are expressed in Kpa (1 bar = 100 Kpa).

## CONFIGURATION









### How to access configuration level

The configuration parameters are collected in various groups. Every group defines all parameters related with a specific function (e.g.: control, alarms, output functions).

1. Push the  button for more than 5 seconds. The upper display will show PASS while the lower display will show 0.
2. Using  and  buttons set the programmed password.  
According to the entered password, it is possible to see a part of the parameters listed in the "configuration parameters" section.
  - a. Enter "30" as password to view all the configuration parameters
  - b. Enter "20" as password to view the parameters of the "limited access level". At this point, only the parameters with attribute **Liv = A** or **Liv = O** will be editable.
  - c. Leave the password blank to edit "user level" parameters, that are identified by attribute **Liv = O**
3. Push the  button. If the password is correct the display will show the acronym of the first parameter group preceded by the symbol: . In other words the upper display will show:  inP (group of the **Input parameters**).

The instrument is in configuration mode. To press  for more than 5 seconds, the instrument will return to the "standard display".

### Keyboard functions during parameter changing:

Operator Mode	
	When the upper display is showing a group and the lower display is blank, this key allows to enter in the selected group. When the upper display is showing a parameter and the lower display is showing its value, this key allows to store the selected value for the current parameter and access the next parameter within the same group.
	Allows to increase the value of the selected parameter.
	Allows to decrease the value of the selected parameter.
	Short presses allow you to exit the current group of parameters and select a new group. A long press terminates the configuration procedure (the instrument returns to the normal display).
 + 	These two keys allow to return to the previous group. Proceed as follows: Push the  button and maintaining the pressure, then push the  ; release both the buttons.

### Configuration Parameters

inP GROUP - input configuration					
Liv	N°	Param	Description	Values	Default
A	1	SEnS	Input type	Pt1 = RTD Pt100 Pt10 = RTD Pt1000 0.20 = 0..20mA 4.20 = 4..20mA Pressure probe 0.10 = 0..10V 2.10 = 2..10V crAL= Thermocouple K	Depends on the probe
A	2	dp	Decimal point position	0... 3	See page 7
A	3	SSc	Initial scale read-out for linear inputs (available only if SEnS parameter is not equal to Pt1, Pt10, crAL values)	-1999... 9999	0
C	4	FSc	Full scale read-out for linear input inputs (available only if SEnS parameter is not equal to Pt1, Pt10, crAL values)	-1999... 9999	Depends on the probe
C	5	unit	Unit of measure (present only in the case of temperature probe)	°C/°F	°C
C	6	Fil	Digital filter on the measured value	0 (= OFF)... 20.0 s	1.0
C	7	inE	Selection of the Sensor Out of Range type that will enable the safety output value	or = Over range ou = Under range our = over e under range	or

C	8	oPE	Safety output value	-100... 100	0
C	9	io4.F	I/O4 function selection	on = Out4 will be ever ON (used as a transmitter power supply) ,out4 = Uscita 4 (Used as digital output 4), dG2c = Digital input 2 for contact closure, dG2U = Digital input 2 driven by 12... 24 VDC	on
C	10	diF1	Digital input 1 function	oFF = Not used, 1 = Alarm reset, 2 = Alarm acknowledge (ACK), 3 = Hold of the measured value, 4 = Stand by mode, 5 = Manual mode, 6 = HEAt with SP1 and Cool with SP2, 7 = Timer RUN/Hold/Reset, 8 = Timer Run, 9 = Timer Reset, 10 = Timer Run/Hold, 11 = Timer Run/Reset, 12 = Timer Run/Reset with lock, 13 = Program Start, 14 = Program Reset, 15 = Program Hold, 16 = Program Run/Hold, 17 = Program Run/Reset, 18 = Sequential SP selection, 19 = SP1 - SP2 selection, 20 = SP1... SP4 binary selection, 21 = Digital inputs in parallel	19
C	12	di.A	Digital Inputs Action (DI2 only if configured)	0 = DI1 direct action, DI2 direct action 1 = DI1 reverse action, DI2 direct action 2 = DI1 direct action, DI2 reverse action 3 = DI1 reverse action, DI2 reverse action	0

**Out GROUP- Output parameters**

Liv	N°	Param	Description	Values	Default
C	14	o1F	Out 1 function	AL = Alarm output	AL
C	15	o1AL	Initial scale value of the analog retransmission	-1999 ... Ao1H	1
C	18	o1Ac	Out 1 action	dir = Direct action rEU = Reverse action dir.r = Direct with reversed LED ReU.r = Reverse with reversed LED	rEU.r
C	19	o2F	Out 2 function	H.rEG = Heating output	H.rEG
C	21	o2Ac	Out 2 action	dir = Direct action rEU = Reverse action dir.r = Direct with reversed LED ReU.r = Reverse with reversed LED	dir
C	22	o3F	Out 3 function	H.rEG = Heating output	H.rEG
C	24	o3Ac	Out 3 action	dir = Direct action rEU = Reverse action dir.r = Direct with reversed LED ReU.r = Reverse with reversed LED	dir

**AL1 GROUP - Alarm 1 parameters**

Liv	N°	Param	Descrizione	Values	Default
C	28	AL1t	Tipo allarme AL1	nonE = Alarm not used LoAb = Absolute low alarm HiAb = Absolute high alarm LHAo = Windows alarm in alarm outside the windows LHAI = Windows alarm in alarm inside the	HidE

				windows SE.br = Sensor Break LodE = Deviation low alarm (relative) HidE = Deviation high alarm (relative) LHdo = Relative band alarm in alarm out of the band LHdi = Relative band alarm in alarm inside the band	
C	29	Ab1	Alarm 1 function	0... 15 +1 = Not active at power up +2 = Latched alarm (manual reset) +4 = Acknowledgeable alarm +8 = Relative alarm not active at set point change	0
C	30	AL1L	-- For High and low alarms, it is the low limit of the AL1 threshold; -- For band alarm, it is low alarm threshold	-1999... AL1H (E.U.)	-199.9
C	31	AL1H	-- For High and low alarms, it is the high limit of the AL1 threshold; -- For band alarm, it is high alarm threshold	AL1L... 9999 (E.U.)	999.9
O	32	AL1	AL1 threshold	AL1L... AL1H (E.U.)	See page 7
O	33	HAL1	AL1 hysteresis	1... 9999 (E.U.)	See page 7
C	34	AL1d	AL1 delay	0 (oFF)... 9999 (s)	oFF
C	35	AL1o	Alarm 1 enabling during Stand-by mode and out of range conditions	0 = Alarm 1 disabled during Stand by and out of range 1 = Alarm 1 enabled in stand by mode 2 = Alarm 1 enabled in out of range condition 3 = Alarm 1 enabled in stand by mode and in overrange condition	1

**GRUPPO AL2 - parametri allarme 2**

Liv	N°	Param	Description	Values	Default
C	36	AL2t	Alarm 2 type	nonE = Alarm not used LoAb = Absolute low alarm HiAb = Absolute high alarm LHAo = Windows alarm in alarm outside the windows LHAI = Windows alarm in alarm inside the windows SE.br = Sensor Break LodE = Deviation low alarm (relative) HidE = Deviation high alarm (relative) LHdo = Relative band alarm in alarm out of the band LHdi = Relative band alarm in alarm inside the band	SE.br
C	37	Ab2	Alarm 2 function	0... 15 +1 = Not active at power up +2 = Latched alarm (manual reset) +4 = Acknowledgeable alarm +8 = Relative alarm not active at set point change	0
C	42	AL2d	AL2 hysteresis	0 (oFF)... 9999 (s)	oFF
C	43	AL2o	Alarm 2 enabling during Stand-by mode and out of range conditions	0 = Alarm 2 disabled during Stand by and out of range 1 = Alarm 2 enabled in stand by mode 2 = Alarm 2 enabled in out of range condition 3 = Alarm 2 enabled in stand by mode and in overrange condition	0

AL3 Group - alarm 3 parameters					
Liv	N°	Param	Description	Values	Default
	44	AL3t	Alarm 3 type	nonE = Alarm not used LoAb = Absolute low alarm HiAb = Absolute high alarm LHAo = Windows alarm in alarm outside the windows LHAI = Windows alarm in alarm inside the windows SE.br = Sensor Break LodE = Deviation low alarm (relative) HidE = Deviation high alarm (relative) LHdo = Relative band alarm in alarm out of the band LHdi = Relative band alarm in alarm inside the band	nonE

LbA Group - Loop break alarm					
Liv	N°	Param	Descrizione	Values	Default
C	52	LbAt	LBA time	Da 0 (oFF) a 9999 (s)	oFF

rEG Group - Control parameters					
Liv	N°	Param	Description	Values	Default
C	56	cont	Control type	Pid = PID (heat and/or) On.FA = ON/OFF asymmetric hysteresis On.FS = ON/OFF symmetric hysteresis nr = Heat/Cool ON/OFF control with neutral zone 3Pt = Servomotor control (available only when Output 2 and Output 3 have been ordered as "M")	3pt
C	57	Auto	Autotuning selection	-4 = Oscillating auto-tune with automatic restart at power up and after all point change -3 = Oscillating auto-tune with manual start -2 = Oscillating -tune with auto-matic start at the first power up only -1 = Oscillating auto-tune with auto-matic restart at every power up 0 = Not used 1 = Fast auto tuning with automatic restart at every power up 2 = Fast auto-tune with automatic start the first power up only 3 = FAST auto-tune with manual start 4 = FAST auto-tune with automatic restart at power up and after set point change 5 = Evo-tune with automatic restart at every power up 6 = Evo-tune with automatic start the first power up only 7 = Evo-tune with manual start 8 = Evo-tune with automatic restart at power up and after a set point change	7
C	58	tunE	Manual start of the Autotuning	oFF = Not active on = Active	oFF

C	59	SELF	Self tuning enabling	no = The instrument does not perform the self-tuning YES = The instrument is performing the self-tuning	No
A	62	Pb	Proportional band	1... 9999 (E.U.)	See page 7
A	63	ti	Integral time	0 (oFF) ... 9999 (s)	See page 7
A	64	td	Derivative time	0 (oFF) ... 9999 (s)	See page 7
C	65	Fuoc	Fuzzy overshoot control	0.00... 2.00	1
C	69	rS	Manual reset (Integral pre-load)	-100.0... +100.0 (%)	0.0
A	70	Str.t	Servomotor stroke time	5...1000 seconds	See page 7
A	71	db.S	Servomotor dead band	0...100%	5
C	72	od	Delay at power up	0.00 (oFF) ... 99.59 (hh.mm)	oFF

**SP Group - Set point parameters**

Liv	N°	Param	Description	Values	Default
C	76	nSP	Number of used set points	1... 4	2
A	77	SPLL	Minimum set point value	-1999 ... SPHL	See page 7
A	78	SPHL	Maximum set point value	SPLL ... 9999	See page 7
O	79	SP	Set point 1	SPLL ... SPLH	See page 7
C	80	SP 2	Set point 2	SPLL ... SPLH	60
	83	A.SP	Selection of the active set point	"SP" ... "nSP"	SP
C	84	SP.rt	Remote set point type	RSP = The value coming from serial link is used as remote set point trin = The value will be added to the local set point selected by A.SP and the sum becomes the operative set point PErc = The value will be scaled on the input range and this value will be used as remote SP	trin
C	85	SPLr	Local/remote set point selection	Loc = Local rEn = Remote	Loc
C	86	SP.u	Rate of rise for POSITIVE set point change (ramp UP)	0.01... 99.99 (inF) Eng. units per minute	inF
C	87	SP.d	Rate of rise for NEGATIVE set point change (ramp DOWN)	0.01... 99.99 (inF) Eng. units per minute	inF

**PAn Group - Operator HMI**

Liv	N°	Param	Description	Values	Default
C	118	PAS2	Level 2 password (limited access level)	oFF (Level 2 not protected by password) 1... 200	20
C	119	PAS3	Level 3 password (complete configuration level)	3... 300	30
C	120	PAS4	Password livello (livello configurazione a codice)	201... 400	300
C	121	uSrb	button function during RUN TIME	nonE = No function tunE = Auto-tune/self-tune enabling. A single press (longer than 1 second) starts the auto-tune oPLo = Manual mode. The first pressure puts the instrument in manual mode (OPLO) while a second one puts the instrument in Auto mode	tunE

				AAC = Alarm reset ASi = Alarm acknowledge chSP = Sequential set point selection St.by = Stand by mode. The first press puts the instrument in stand by mode while a second one puts the instrument in Auto mode. Str.t = Timer run/hold/reset P.run = Program run P.rES = Program reset P.r.H.r = Program run/hold/reset	
C	122	diSP	Display management	Spo = Operative set point	SPO
C	123	di.cL	Display colour	0 = The display colour is used to show the actual deviation (PV - SP) 1 = Display red (fix) 2 = Display green (fix) 3 = Display orange (fix)	2
	125	diS.t	Display Timeout	-- oFF (display always ON) -- 0.1... 99.59 (mm.ss)	oFF
C	126	fiLd	Filter on the displayed value	-- oFF (filter disabled) -- From 0.0 (oFF) to 20.0 (E.U.)	oFF
C	128	dSPu	Instrument status at power ON	AS.Pr = Starts in the same way it was prior to the power down Auto = Starts in Auto mode oP.0 = Starts in manual mode with a power output equal to zero St.bY = Starts in stand-by mode	Auto
C	129	oPr.E	Operative modes enabling	ALL = All modes will be selectable by the next parameter Au.oP = Auto and manual (OPLO) mode only will be selectable by the next parameter Au.Sb = Auto and Stand-by modes only will be selectable by the next parameter	ALL
C	130	oPEr	Operative mode selection	If oPr.E = ALL: - Auto = Auto mode - oPLo = Manual mode - St.bY = Stand by mode If oPr.E = Au.oP: - Auto = Auto mode - oPLo = Manual mode If oPr.E = Au.Sb: - Auto = Auto mode - St.bY = Stand by mode	Auto

**SEr Group - Serial link parameter**

Liv	N°	Param	Description	Values	Default
C	131	Add	Instrument address	-- oFF -- 1... 254	1
C	132	bAud	baud rate	1200 = 1200 baud 2400 = 2400 baud 9600 = 9600 baud 19.2 = 19200 baud 38.4 = 38400 baud	9600
C	133	trSP	Selection of the value to be retransmitted (Master)	nonE = Retransmission not used (the instrument is a slave) rSP = The instrument becomes a Master and retransmits the operative set point PErc = The instrument become a Master and it retransmits the power output	nonE

con Group - Consumption parameters					
Liv	N°	Param	Description	Values	Default
C	134	Co.tY	Count type	<p>oFF = Not used</p> <p>1 = Instantaneous power (kW)</p> <p>2 = Power consumption (kW/h)</p> <p>3 = Energy used during program execution. This measure starts from zero when a program runs end stops at the end of the program. A new program execution will reset the value</p> <p>4 = Total worked days: number of hours the instrument is turned ON divided by 24.</p> <p>5 = Total worked hours: number of hours the instrument is turned ON.</p> <p>6 = Total worked days with threshold: number of hours the instrument is turned ON divided by 24, the controller is forced in stand-by when Co.ty value reaches the threshold set in [137] h.Job.</p> <p>7 = Total worked hours with threshold: number of hours the instrument is turned ON, the controller is forced in stand-by when Co.ty value reaches the threshold set in [137] h.Job.</p> <p>8 = Totalizer of control relay worked days: number of hours the control relay has been in ON condition, divided by 24.</p> <p>9 = Totalizer of control relay worked hours: number of hours the control relay has been in ON condition.</p> <p>10 = Totalizer of control relay worked days with threshold: number of hours the control relay has been in ON condition divided by 24, the controller is forced in stand-by when Co.ty value reaches the threshold set in [137] h.Job.</p> <p>11 = Totalizer of control relay worked hours with threshold: number of hours the control relay has been in ON condition, the controller is forced in stand-by when Co.ty value reaches the threshold set in [137] h.Job.</p>	oFF
C	138	t.Job	Worked time (not resettable)	0... 9999 days	0

cAL Group - User calibration group					
Liv	N°	Param	Description	Values	Default
C	139	AL.P	Adjust Low Point	From -1999 to (AH.P - 10) in engineering units	0
C	140	AL.o	Adjust Low Offset	-300... +300 (E.U.)	0
C	141	AH.P	Adjust High Point	From (AL.P + 10) to 9999 engineering units	999.9
C	142	AH.o	Adjust High Offset	-300... +300	0

## OPERATIVE MODES

When the instrument is powered, it starts immediately to work according to the parameters values loaded in its memory. The instrument behaviour and its performance are governed by the value of the stored parameters.

At power ON the instrument can start in one of the following mode depending on its configuration:

**Automatic Mode** In Automatic mode the instrument drives automatically the control output according to the parameter value set and the set point/measured value.

**Manual Mode (OPLO):** In Manual mode the the upper display shows the measured value while the lower display shows the power output The lower display shows the power output [preceded by H (for heating) or C (for cooling)], MAN is lit and the instrument allows you to set manually the control output power. No Automatic action will be made.





**Stand by Mode (St.bY):** In stand-by mode the instrument operates as an indicator. It will show on the upper display the measured value and on the lower display the set point alternately to the "St.bY" messages and forces the control outputs to zero.

We define all the above described conditions as "Standard Display".

As we have seen, it is always possible to modify the value assigned to a parameter independently from the operative modes selected.









## AUTOMATIC MODE

Keyboard function when the instrument is in Auto mode:

Modo Operatore	
	Allows entry into parameter modification procedures
	Allows you to start the "Direct set point modification" function (see below).
	Allows you to display the "additional informations" (see below).
	Performs the action programmed by [121] uSrb (  button function during RUN TIME) parameter

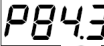
### Additional information





This instrument is able to show you some additional informations that can help you to manage your system. The additional informations are related to how the instrument is programmed, hence in many cases, only part of this information is available.

1. When the instrument is showing the "standard display" push  button. The lower display will show H or c followed by a number. This value is the current power output applied to the process. The H show you that the action is a Heating action while the "c" show you that the action is a Cooling action
2. Push  button again. When the programmer is running the lower display will show the segment currently performed and the Event status as shown below:  
 where the first character can be r for a ramp or S for a soak, the next digit show the number of the segment (e.g. S3 means Soak number 3) and the twoless significant digits (LSD) show you the status of the two event (the LSD is the Event 2)..
3. Push  button again. When the programmer is running the lower display will show the theoretical remaining time to the end of the program preceded by a "P" letter:  

4. Push  button again. When the wattmeter function is running the lower display will show U followed by the measured energy..
5. Push  button. When the "Worked time count" is running the lower display will show "d" for days or "h" for hours followed by the measured time.
6. Push  button. The instrument returns to the "standard display".



Note: The additional information visualization is subject to a time out. If no button is pressed for more than 10 second the instrument comes automatically back to the Standard display..

**Direct set point modification**

This function allows to modify rapidly the set point value selected by [83] A.SP (selection of the active Set point) or to the set point of the segment group (of the programmer) currently in progress.

1. Push  button. The upper display shows the acronym of the selected set point (e.g. SP2) and the lower display will show its value.
2. By  and  buttons, assign to this parameter the desired value
3. Do not push any button for more than 5 second or push the  button. In both cases the instrument memorize the new value and come back to the “standard display”.

**Manual mode**

This operative mode allows you to deactivate automatic control and manually program the percentage power output to the process. When the instrument is in manual mode, the upper display shows the measured value while the lower display shows the power output [preceded by H (for heating action) or C (for cooling action)] The MAN LED is lit. When manual control is selected, the instrument will start to operate with the same power output as the last one supplied by automatic mode and can be modified using the  and  buttons.

In case of ON/OFF control, 0% corresponds to the deactivated output while any value different from 0 corresponds to the activated output. As in the case of visualization, the programmable values range from H100 (100% output power with reverse action) to C100 (100% output power with direct action).

**Notes:**

- During manual mode, the alarms are operative.
- If you set manual modes during program execution, the program will be frozen and it will restart when the instrument will come back to Auto mode.
- If you set manual modes during self-tune execution, the self- tune function will be aborted.
- During manual mode, all functions not related with the control (wattmeter, independent timer, “worked time”, etc) continue to operate normally..

**STAND-BY MODE**

This operative mode also deactivates the automatic control but forces the control output to zero. In this mode the instrument operates as an indicator. When the instrument is in stand by mode the upper display will show the measured value while the lower display will show alternately the set point and the message “St.bY”.

**Notes:**

- During stand by mode, the relative alarms are disabled while the absolute alarms are operative or not according to the ALx0 (Alarm x enabling during Stand-by mode) parameter setting.
- If you set stand by mode during program execution, the program will be aborted.
- If you set stand by mode during self-tune execution, the self- tune function will be aborted.
- During stand by mode, all functions not related with the control (wattmeter, independent timer, “worked time”, etc) continue to operate normally.
- When the instrument is swapped from stand by to auto modes, the instrument will start automatically the alarm masking, the soft start functions and the auto-tune (if programmed).

**AUTOTUNE (EVOTUNE)**

Evotune is a fast and fully automatic procedure that can be started in any condition, regardless the deviation from SP. The controller selects automatically the best tune method and computes the optimum PID parameters. To activate Evotune press  button for 3 seconds.

## ERROR MESSAGES

The upper display shows the OVER-RANGE and UNDERRANGE conditions with the following indications:

Over-range: 

Under-range 

The sensor break will be signalled as an out of range: - - - -

Note: When an over-range or an under-range is detected, the alarms operate as in presence of the maximum or the minimum measurable value respectively.

To check the out of span Error condition, proceed as follows:

1. Check the input signal source and the connecting line.
2. Make sure that the input signal is in accordance with the instrument configuration. Otherwise, modify the input configuration.
3. If no error is detected, send the instrument to your supplier to be checked.

### List of possible errors

**ErAT** Fast Auto-tune cannot start. The measure value is too close to the set point. Push the button in order to delete the error message.

**ouLd** Overload on the out 4. The messages shows that a short circuit is present on the Out 4 when it is used as output or as a transmitter power supply. When the short circuit disappears the output restart to operate..

**NoAt** Auto-tune not finished within 12 hours.

**ErEP** Possible problem of the instrument memory. The messages disappears automatically. When the error continues, send the instrument to your supplier.





**RonE** Possible problem of the firmware memory. When this error is detected, send the instrument to your supplier.

**Errt** Possible problem of the calibration memory. When this error is detected, send the instrument to your supplier.

## FACTORY RESET

Sometime, e.g. when you re-configure an instrument previously used for other works or from other people or when you have made too many errors during configuration and you decided to re-configure the instrument, it is possible to restore the factory configuration. This action allows to put the instrument in a defined condition (the same it was at the first power ON).

The default data are those typical values loaded in the instrument prior to ship it from factory. To load the factory default parameter set, proceed as follows:

1. Press the  button for more than 5 seconds. The upper display will show PASS while the lower display shows 0;
2. Using  and  buttons set the value -481;
3. Push  button;
4. The instrument will turn OFF all LEDs for a few seconds, then the upper display will show dFLt (default) and then all LEDs are turned ON for 2 seconds. At this point the instrument restarts as for a new power ON.

The procedure is complete.

Note: The complete list of the default parameters is available in Chapter "Configuration".

# RWF55.5X & RWF55.6X



*User manual*

## DEVICE INSTALLATION

### Fixing system

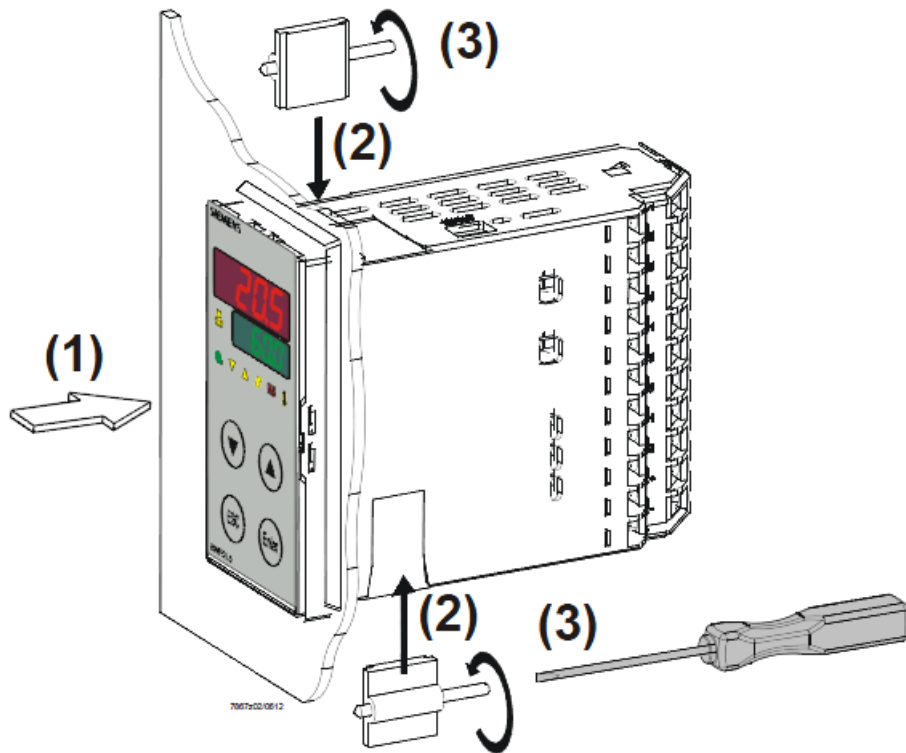

### Drilling dimensions:

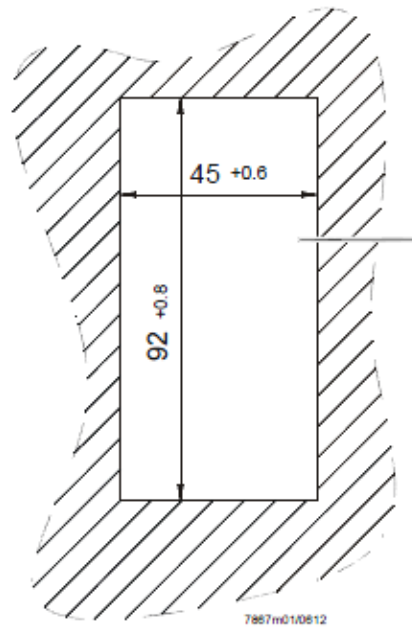

# FRONT PANEL

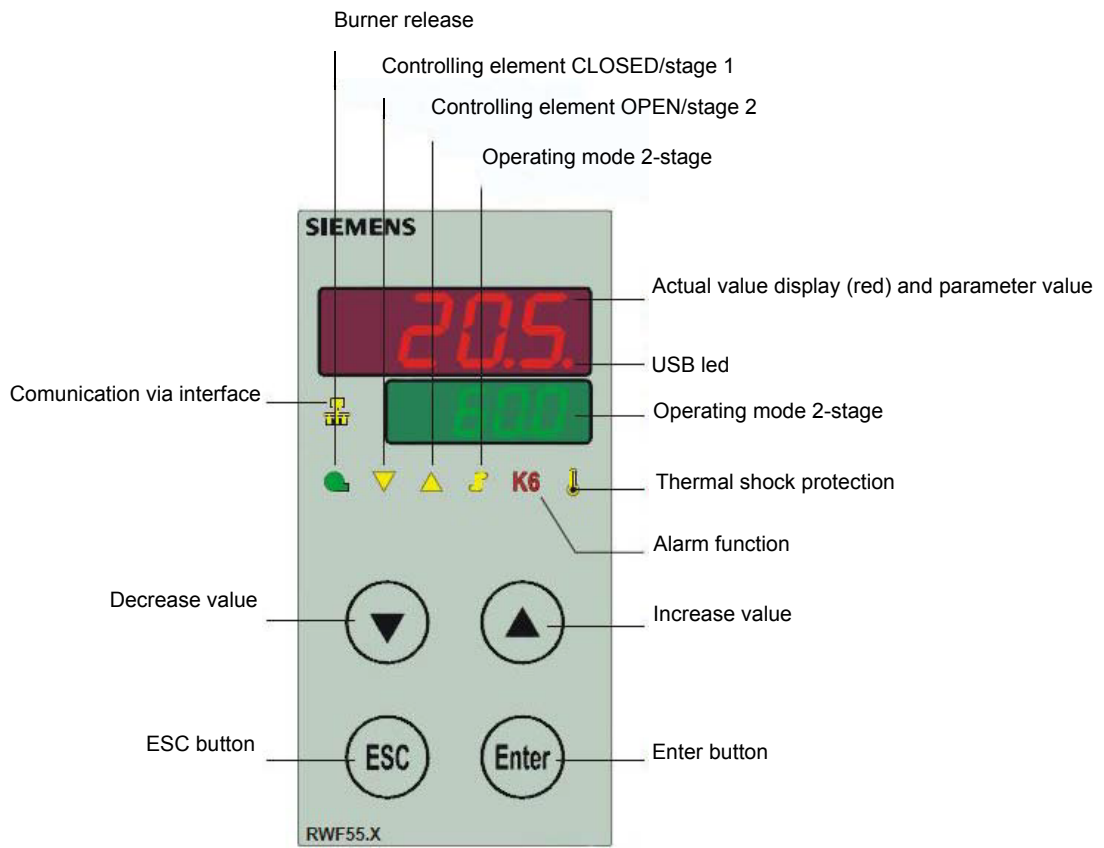

# NAVIGATION MENU

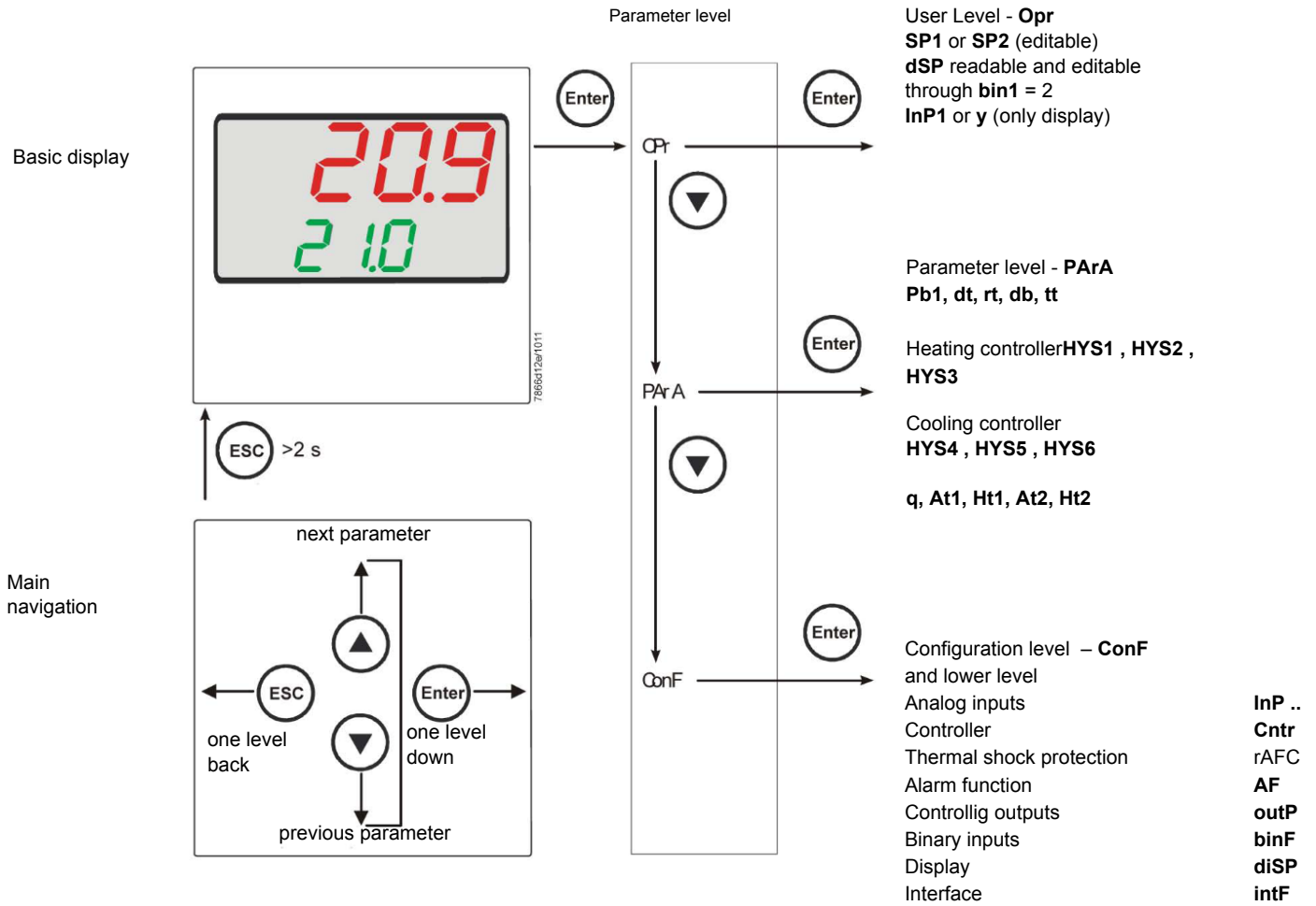

RWF55 is preset good for 90% of applications. However, you can set or edit parameters as follow:

## Set-point: set or modification:

When the burner is in stand-by, (safety loop open, that is terminals 3-4/T1-T2 on the 7 pole plug open) push the Enter button: on the lower display (green) Opr appears; push Enter again and in the same display SP1 appears. Push Enter again and the lower display (green SP1) flashes. Using the up and down arrows change the set-point on the upper display (red).Push Enter to confirm and push ESC more times to get the home position.

### **PID parameters set and modifications (PARA):**

Push **Enter** button, on the green display **Opr** appears; using the **down arrow**, scroll until group **PARA** is reached and push **Enter**.  
On the green display **Pb1** e appears and on the red one the set parameter. Push in sequence the **down or up** arrow the menu is scrolled.  
Push **Enter** to select and the **arrows** to choose the desired value. **Enter** to confirm

Parameter	Display	Range	Factory setting	Remarks
Proportional band	Pb1	1... 9999 digit	10	Typical value for temperature
Derivative action	dt	0... 9999 sec.	80	Typical value for temperature
Integral action	rt	0... 9999 sec.	350	Typical value for temperature T
Dead band (*)	db	0... 999,9 digit	1	Typical value
Servocontrol running time	tt	10... 3000 sec.	15	Set servocontrol running time
Switch-on differential (*)	HYS1	0,0... -1999 digit	-5	Value under setpoint below which the burner switches back on (1N-1P closes)
Switch-off differential 2° stage (*)	HYS2	0,0 ... HYS3	3	(enable only with parameter bin1 = 4)
Upper switch-off differential (*)	HYS3	0,0... 9999 digit	5	Value over setpoint above which the burner switches off (1N-1P opens)
Switch-on differential on cooling controller (*)	HYS4	0,0... 9999 digit	5	Do not used (enable only with parameter <b>CACT</b> = 0)
Switch-off differential 2° stage on cooling controller (*)	HYS5	HYS6...0,0 digit	5	Do not used (enable only with parameter <b>CACT</b> = 0 and parameter <b>bin1</b> =0)
Upper switch-off differential on cooling controller (*)	HYS6	0,0... -1999 digit	5	Do not used (enable only with parameter <b>CACT</b> = 0)
Delay modulation	q	0,0... 999,9 digit	0	Do not alter
T Outside temperature Curve point 1 (*)	At1	-40 ...120 digit	-10	First point of external temperature for climatic curve
Boiler temperature Curve point 1 (*)	Ht1	SPL...SPH	60	Set-point temperature for the external temperature 1
TT Outside temperature Curve point 2 (*)	At2	-40 ...120 digit	20	Second point of external temperature for climatic curve
Boiler temperature Curve point 2 (*)	Ht2	SPL...SPH	50	Set-point temperature for the external temperature 2

(\*) Parameters affected by setting of decimal place (**ConF** > **dISP** parameter **dECP**)

### Setting the kind of sensor to be connected to the device:

Push the **Enter** button: on the lower display (green) **Opr** appears. Using the **up and down arrows** find **ConF**. Push **Enter** to confirm. Now on the green display the group **InP** appears. Push **Enter** and **InP1** is displayed. Enter to confirm. You are inside **InP1**; the green display shows **Sen1 (sensor type)**, while the red display shows the chosen sensor code Push **Enter** to enter the **Sen1** parameter, then choose the desired sensor using the **arrows**. Push **Enter** to confirm and **ESC** to escape.

Once selected the sensor, you can modify all the other parameters using **up and down arrows** according to the tables here below :

#### ConF > InP > InP1

Parameter	Value	Description
SEn1 type of sensor for analog input 1	1	Pt100 3 wire
	2	Pt100 2 wire
	3	Pt1000 3 wire
	4	Pt1000 2 wire
	5	Ni1000 3 wire
	6	Ni1000 2 wire
	7	0 ÷ 135 ohm
	8	Cu-CuNi T
	9	Fe-CuNi J
	10	NiCr-Ni K
	11	NiCrSi-NiSi N
	12	Pt10Rh-Pt S
	13	Pt13Rh-Pt R
	14	Pt30Rh-Pt6Rh B
	15	0 ÷ 20mA
	16	4 ÷ 20mA
	17	0 ÷ 10V
	18	0 ÷ 5V
	19	1 ÷ 5V
OFF1 Sensor offset	-1999..0.. +9999	Correction value measured by the sensor
SCL1 scale low level	-1999..0.. +9999	minimum scale value(for input ohm, mA, V)
SCH1 scale high level	-1999.. <b>100</b> .. +9999	maximum scale value(for input ohm, mA, V)
dF1 digital filter	0... <b>0,6</b> ...100	Is used to adapt the digital 2nd order input filter (time in s; 0 s = filter off)
Unit temperature unit	<b>1</b>	1 = <b>degrees</b> Celsius
	2	2 = degrees Fahrenheit

(**bold** = factory settings)

---

### ConF > InP > InP2

Input 2 : this input can be used to specify an external setpoint or carry out setpoint shifting

Parameter	Value	Description
FnC2	0	0= <b>no function</b>
	1	1= external setpoint (display <b>SPE</b> )
	2	2 =setpoint shifting (display <b>dSP</b> )
	3	3 = angular positioning feedback
SEn2 sensor type input 2	1	0 ÷ 20mA
	2	4 ÷ 20mA
	3	0 ÷ 10V
	4	0 ÷ 5V
	5	1 ÷ 5V
	1	0 ÷ 20mA
OFF2 Sensor offset	-1999..0.. +9999	Correction value measured by the sensor
SCL2 scale low level	-1999..0.. +9999	minimum scale value(for input ohm, mA, V)
SCH2 scale high level	-1999.. <b>100</b> .. +9999	maximum scale value(for input ohm, mA, V)
dF2 digital filter	0... <b>2</b> ...100	Is used to adapt the digital 2nd order input filter (time in s; 0 s = filter off)

(**bold** = factory settings)

### ConF > InP > InP3

Input 3: this input is used to acquire the outside temperature

Parameter	Value	Description
SEn3 sensor type input 3 sensor type input 2	0	0 =
	1	1 = wire
	2	2 = wire
OFF3 Sensor offset	-1999..0.. +9999	Correction value measured by the sensor
dF3 digital filter	0... <b>1278</b> ...1500	Is used to adapt the digital 2nd order input filter (time in s; 0 s = filter off)

(**bold** = factory settings)

### ConF > Cntr

Here, the type of controller, operating action, setpoint limits and presettings for self-optimization are selected

Parameter	Value	Description
CtYP controller type	1 2	<b>1 = 3-position controller (open-stop-close)</b> 2 = continuative action controller (0 ÷ 10V or 4 ÷ 20mA)
CACT control action	1 0	1 = <b>heating controller</b> 0 = cooling controller
SPL least value of the set-point range	-1999..0..+9999	minimum set-point scale
SPH maximum value of the set-point range	-1999..100..+999	maximum set-point scale
Self-optimization	0 1	0 = <b>Free</b> 1 = Locked Self-optimization can only be disabled or enabled via the ACS411 setup program. Self-optimization is also disabled when the parameter level is locked
oLLo set-point limitation start, operation limit low	-1999.... +9999	lower working range limit
oLHi set-point limitation end, operation limit high	-1999.... <b>+9999</b>	upper working range limit

(bold = factory settings)

### ConF > rAFC

Activation boiler shock termic protetion:

RWF55.. can activate the thermal shock protection only on sites where the set-point is lower than 250°C and according to **rAL** parameter

Parameter	Value	Description
FnCT type of contol	0 1 2	choose type of range degrees/time <b>0 = deactivated</b> 1 = Kelvin degrees/minute 2 = Kelvin degrees/hour
rASL ramp rate	0,0 ... 999,9	Slope of thermal shock protection (only with functions 1 and 2)
toLP tolerance band ramp	2 x (HYS1) = 10...9999	width of tolerance band (in K) about the set-point <b>0 = tolerance band inactive</b>
rAL ramp limit	0...250	Ramp limit. When this value is lower than the temperature set-point, the RWF controls the output increasing the temp set point step by step according to <b>rASL</b> . If this is over the temp set point, the control is performed in cooling

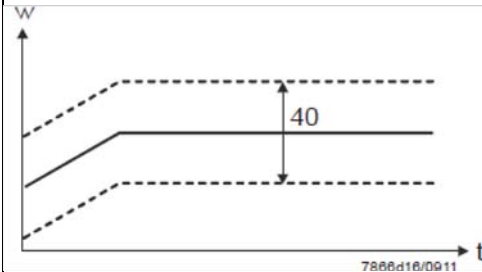

(bold = factory settings)

## Alarm function AF

The alarm function can be used to monitor the analog inputs. If the limit value is exceeded, multifunctional relay K6 (terminals **6N** and **6P**) is activated (depending on the switching characteristic)

The alarm function can have different switching functions (Ik1 to Ik8) and can be set to a deviation from the active setpoint or to a fixed limit value

Limit value **AL** relative to setpoint (x)

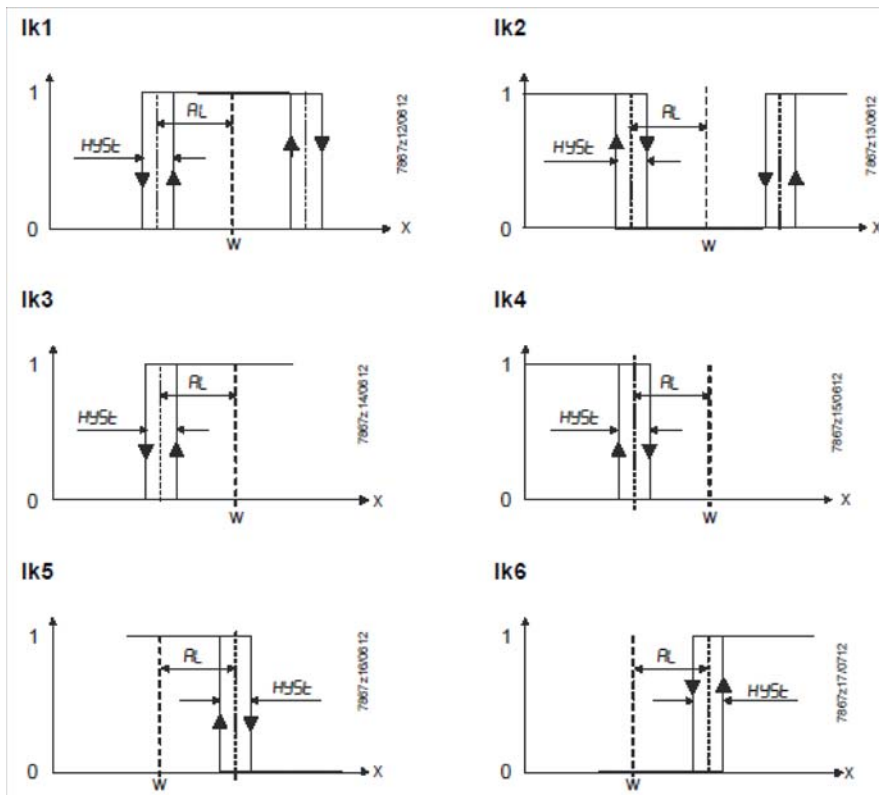

Fixed limit value **AL**

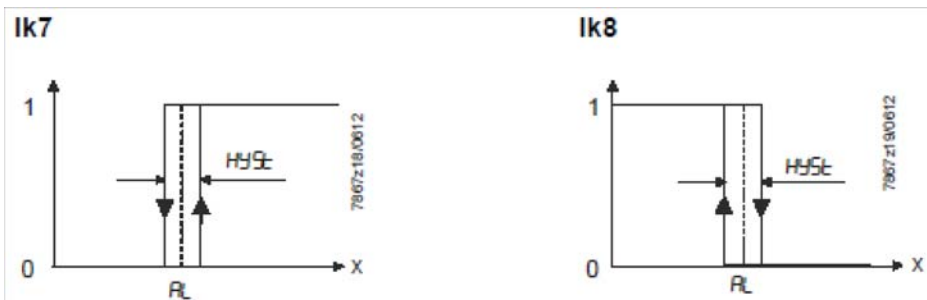

## ConF > AF

Parameter	Value	Description
FnCt type of control	0 1 2 3 4 5 6 7 8 9 10 11 12	0 = <b>Without function</b> lk1 = monitored input InP1 lk2 = monitored input InP1 lk3 = monitored input InP1 lk4 = monitored input InP1 lk5 = monitored input InP1 lk6 = monitored input InP1 lk7 = monitored input InP1 lk8 = monitored input InP1 lk7 = monitored input InP2 lk8 = monitored input InP2 lk7 = monitored input InP3 lk8 = monitored input InP3
Alarm value AL	-1999 ... <b>0</b> 1999	Limit value or deviation from setpoint to be monitored (see alarm functions <b>lk1 to lk8</b> : limit value <b>AL</b> ) Limit value range for <b>lk1</b> and <b>lk20</b> ...9999
HySt switching differential	0... 1... 9999	Switching differential for limit value <b>AL</b>
ACrA response by out of range	<b>0</b> 1	<b>Switched-off</b> ON Switching state in the case of measuring range overshoot or undershoot (Out of Range)

(**bold** = factory settings)

## ConF > OutP

For fuel-air ratio control purposes, the RWF55 has the binary outputs K2, K3 (terminals KQ, K2, K3) and the analog output (terminals A+, A-). The burner is released via relay K1 (terminals 1N, 1P).

The binary outputs of the RWF55 offer no setting choices

The RWF55 has an analog output.

The analog output offers the following setting choices:

Parameter	Value	Description
FnCt type of control	1 2 3 <b>4</b>	1 = analog input 1 doubling with possibility to convert 2 = analog input 2 doubling with possibility to convert 3 = analog input 3 doubling with possibility to convert <b>4 = Controller's angular positioning is delivered (modulating controller)</b>
SiGn type of output signal	<b>0</b> 1 2	physical output signal (terminals A+, A-) <b>0 = 0÷20mA</b> 1 = 4÷20mA 2 = 0÷10V DC
rOut value when out of input range	<b>0</b> ...101	signal (in percent) when measurement range is crossed
oPnt zero point	-1999... <b>0</b> ...+9999	A value range of the output variable is assigned to a physical output signal (for <b>FnCt</b> = 1, 2, 3)
End end point	-1999... <b>100</b> ...+9999	A value range of the output variable is assigned to a physical output signal (for <b>FnCt</b> = 1, 2, 3)

(**bold** = factory settings)

## ConF > binF

This setting decides on the use of the binary inputs **D1**, **D2**, **DG**

b

Parameter	Value	Description
bin1 binary input 1 (terminals <b>DG</b> – <b>D1</b> )	<b>0</b> 1 2 3	<b>0 = without function</b> 1 = set-point changeover (SP1 / SP2) 2 = Iset-point shift (Opr > dSP parameter = value of set-point modify) 3 = input alarm
bin2 binary input 2 (terminals <b>DG</b> – <b>D2</b> )	<b>4</b>	<b>changeover of operating mode</b> DG-D2 open = modulating operation DG-D2 close = 2 stage operation

(**bold** = factory settings)

## ConF > dISP

.Both displays can be customized to suit your needs by configuring the displayed value, decimal, time out and blocking

Parameter	Value	Description
diSU upper display (red)	<b>0</b> 1 2 3 4 6 7	Display value for upper display: 0 = display power-off <b>1 = analog input 1 (InP1) value</b> 2 = analog input 2 (InP2) value 3 = analog input 3 (InP3) value 4 = controller's angular positioning 6 = set-point values 7 = end value with thermal shock protection
diSL lower display (green)	<b>0</b> 1 2 3 4 <b>6</b> 7	Display value for lower display: 0 = display power-off 1 = analog input 2 (InP2) value 2 = analog input 2 (InP2) value 3 = analog input 2 (InP2) value 4 = controller's angular positioning <b>6 = set-point values</b> 7 = end value with thermal shock protection
tout timeout	0.. <b>180</b> ..250	time (s) on completion of which the controller returns automatically to the basic display, if no button is pressed
dECP decimal point	<b>0</b> 1 2	<b>0 = no decimal place</b> 1 = one decimal place 2 = two decimal place
CodE level lockout	<b>0</b> 1 2 3	<b>0 = no lockout</b> 1 = configuration level lockout ( <b>ConF</b> ) 2 = parameter and configuration level lockout ( <b>PARa</b> & <b>ConF</b> ) 3 = keyboard lockout

(**bold** = factory settings)

## ConF > IntF

The controller can be integrated into a data network using an optional RS-485 (terminals R+ and R-) interface or an optional Profibus DP interface(only model **RWF55.6x** terminals C1-C2-C3-C4)

Parameter	Value	Description
bdrt	<b>0</b>	<b>0 = 4800 baud</b>
baudrate	1	1 = 9600 baud
	2	2 = 19200 baud
	3	3 = 38400 baud
Adr	0..	Address in the data network
Device address Modbus	1..	
	254	
dP	0.. <b>125</b>	only with RWF55.6x
Device address Profibus		
dt	0..	0 = switched-off
Remote detection time	<b>30</b> ..	
	7200s	

(**bold** = factory settings)

### Manual control :

In order to manual change the burner load, while firing keep pushing the **ESC** button for more than 5 s; on the lower green display **Hand** appears.

using the **UP** and **DOWN** arrows, the load varies.

Keep pushing the **ESC** button for getting the normal operation again.

NB: every time the device shuts the burner down (start led switched off - contact 1N-1P open), the manual control is not active.

### Device self-setting (auto-tuning):

If the burner in the steady state does not respond properly to heat generator requests, you can activate the Device's self-setting function, which recalculates PID values for its operation, deciding which are most suitable for the specific kind of request



Follow the below instructions:

push the **UP** and **DOWN** arrows for more than 5 s; on the green lower display **tUnE** appears. Now the device pushes the burner to increase and decrease its output. During this time, the device calculates **PID** parameters (**Pb1**, **dt** and **rt**). After the calculations, the **tUnE** is automatically deactivated and the device has already stored them.

In order to stop the Auto-tuning function while it works, push again the **UP** and **DOWN** arrows for more than 5 s. The calculated **PID** parameters can be manually modified following the previously described instructions.

### Display of software version :

The software version is shown by pushing Enter + UP arrow on the upper display.



### Weather-compensated setpoint shifting (climatic regulation):

The RWF55 can be configured so that weather-compensated setpoint shifting is activated when an LG-Ni1000 outside sensor or a Pt1000 is connected (see parameter **InP3**).

To take into account the time response of a building, weather-compensated setpoint shifting uses the attenuated outside temperature rather than the current outside temperature.

The minimum and maximum setpoints can be set using the lower setpoint limit **SPL** and the upper setpoint limit **SPH** of the menu **Crtr**.

The system also prevents the lower working range limit **oLLo** and upper working range limit **oLHi** from exceeding/dropping below the system temperature limits.

The heating curve describes the relationship between the boiler temperature setpoint and the outside temperature. It is defined by 2 curve points. For 2 outside temperatures, the user defines the boiler temperature setpoint that is required in each case. The heating curve for the weather-compensated setpoint is calculated on this basis. The effective boiler temperature setpoint is limited by the upper setpoint limit **SPH** and the lower setpoint limit **SPL**.

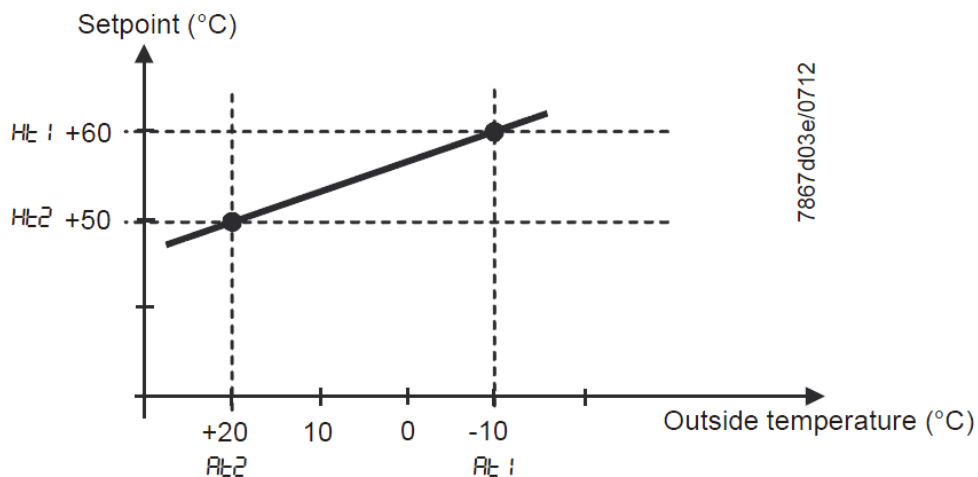

For setting climatic regulation function set:

**PArA** > parameters **At1**, **Ht1**, **At2**, **Ht2**

**ConF** > **InP** > **InP3** parameters **SEn3**, **FnC3** = 1 (Weather-compensated setpoint).

---

## Modbus interface

The tables that follow in this chapter specify the addresses of the readable and writable words that the customer is able to access. The customer may read and/or write the values using SCADA programs, PLCs, or similar.

The entries under Access have the following meanings:

**R/O** Read Only, value can only be read

**R/W** Read/Write, value can be read and written

The number of characters specified under Data type in the case of character strings includes the final \0.

Char10 means that the text is up to 9 characters long. The final \0 character is then added to this

### User level

Address	Access	Data type	Signal reference	Parameter
0x0000	R/O	Float	X1	Analog input InP1
0x0002	R/O	Float	X2	Analog input InP2
0x0004	R/O	Float	X3	Analog input InP2
0x0006	R/O	Float	WR	Actual setpoint
0x0008	R/W	Float	SP1	Setpoint 1
0x000A	R/W	Float	SP2 (= dSP)	Setpoint 2
0x1035	R/O	Float	---	Analog input InP3 (unfiltered)
0x1043	R/O	Float	---	Actual angular positioning
0x1058	R/O	Word	B1	Burner alarm

### Parameter level

Address	Access	Data type	Signal reference	Parameter
0x3000	R/W	Float	Pb1	Proportional range 1
0x3004	R/W	Float	dt	Derivative action time
0x3006	R/W	Float	rt	Integral action time
0x300C	R/W	Float	db	Dead band
0x3012	R/W	Word	tt	Controlling element running time
0x3016	R/W	Float	HYS1	Switch-on threshold
0x3018	R/W	Float	HYS2	Switch-off threshold down
0x301A	R/W	Float	HYS3	Switch-off threshold up
0x301C	R/W	Float	HYS4	Switch-on threshold (cooling)
0x301E	R/W	Float	HYS5	Switch-off threshold down (cooling)
0x3020	R/W	Float	HYS6	Switch-off threshold up (cooling)
0x3022	R/W	Float	q	Reaction threshold
0x3080	R/W	Float	At1	Outside temperature 1
0x3082	R/W	Float	Ht2	Boiler temperature 1
0x3084	R/W	Float	At2	Outside temperature 2
0x3086	R/W	Float	Ht2	Boiler temperature 2

## Configuration level

Address	Access	Data type	Signal reference	Parameter
0x3426	R/W	Float	SCL1	Start of display input 1
0x3428	R/W	Float	SCH1	End of display input 1
0x3432	R/W	Float	SCL2	Start value input 2
0x3434	R/W	Float	SCH2	End value input 2
0x3486	R/W	Float	SPL	Start of setpoint limitation
0x3488	R/W	Float	SPH	End of setpoint limitation
0x342A	R/W	Float	OFFS1	Offset input E1
0x3436	R/W	Float	OFFS2	Offset input E2
0x343A	R/W	Float	OFFS3	Offset input E3
0x1063	R/W	Word	FnCt	Ramp function
0x1065	R/W	Float	rASL	Ramp slope
0x1067	R/W	Float	toLP	Tolerance band ramp
0x1069	R/W	Float	rAL	Limit value
0x1075	R/W	Float	dtT	Remote Detection Timer
0x1077	R/W	Float	dF1	Filter constant input 1
0x1079	R/W	Float	dF2	Filter constant input 2
0x107B	R/W	Float	dF3	Filter constant input 3
0x107D	R/O	Float	oLLo	Lower working range limit
0x107F	R/O	Float	oLHi	Upper working range limit
0x106D	R/W	Word	FnCt	Alarm relay function
0x106F	R/W	Float	AL	Alarm relay limit value (limit value alarm)
0x1071	R/W	Float	HYSt	Alarm relay hysteresis

## Remote operation

Address	Access	Data type	Signal reference	Parameter
0x0500	R/W	Word	REM	Activation remote operation *
0x0501	R/W	Word	rOFF	Controller OFF in remote setpoint **
0x0502	R/W	Float	rHYS1	Switch-on threshold remote
0x0504	R/W	Float	rHYS2	Switch-off threshold down remote
0x0506	R/W	Float	rHYS3	Switch-off threshold up remote
0x0508	R/W	Float	SPr	Setpoint remote
0x050A	R/W	Word	RK1	Burner release remote operation
0x050B	R/W	Word	RK2	Relay K2 remote operation
0x050C	R/W	Word	RK3	Relay K3 remote operation
0x050D	R/W	Word	RK6	Relay K6 remote operation
0x050E	R/W	Word	rStEP	Step-by-step control remote operation
0x050F	R/W	Float	rY	Angular positioning output remote operation
0x0511	R/W	Float	rHYS4	Switch-on threshold remote (cooling)
0x0513	R/W	Float	rHYS5	Switch-off threshold down remote (cooling)
0x0515	R/W	Float	rHYS6	Switch-off threshold up remote (cooling)

### Legend

\* = Local

\*\* = Controller OFF

**Dati dell'apparecchio**

Address	Access	Data type	Signal reference	Parameter
0x8000	R/O	Char12	---	Software version
0x8006	R/O	Char14	---	VdN number

**Stato dell'apparecchio**

Address	Access	Data type	Signal reference	Parameter
0x0200	R/O	Word	---	Outputs and states
			Bit 0	Output 1
			Bit 1	Output 3
			Bit 2	Output 2
			Bit 3	Output 4
			Bit 8	Hysteresis limitation
			Bit 9	Control system
			Bit 10	Self-optimization
			Bit 11	Second setpoint
			Bit 12	Measuring range overshoot InP1
			Bit 13	Measuring range overshoot InP2
			Bit 14	Measuring range overshoot InP3
			Bit 15	Calibration mode
0x0201	R/O	Word	---	Binary signals and hardware detection
			Bit 0	Operation mode 2-stage
			Bit 1	Manual mode
			Bit 2	Binary input D1
			Bit 3	Binary input D2
			Bit 4	Thermostat function
			Bit 5	First controller output
			Bit 6	Second controller output
			Bit 7	Alarm relay
			Bit 13	Analog output available
			Bit 14	Interface available

**Electric connections :**

With 7 pins connector version

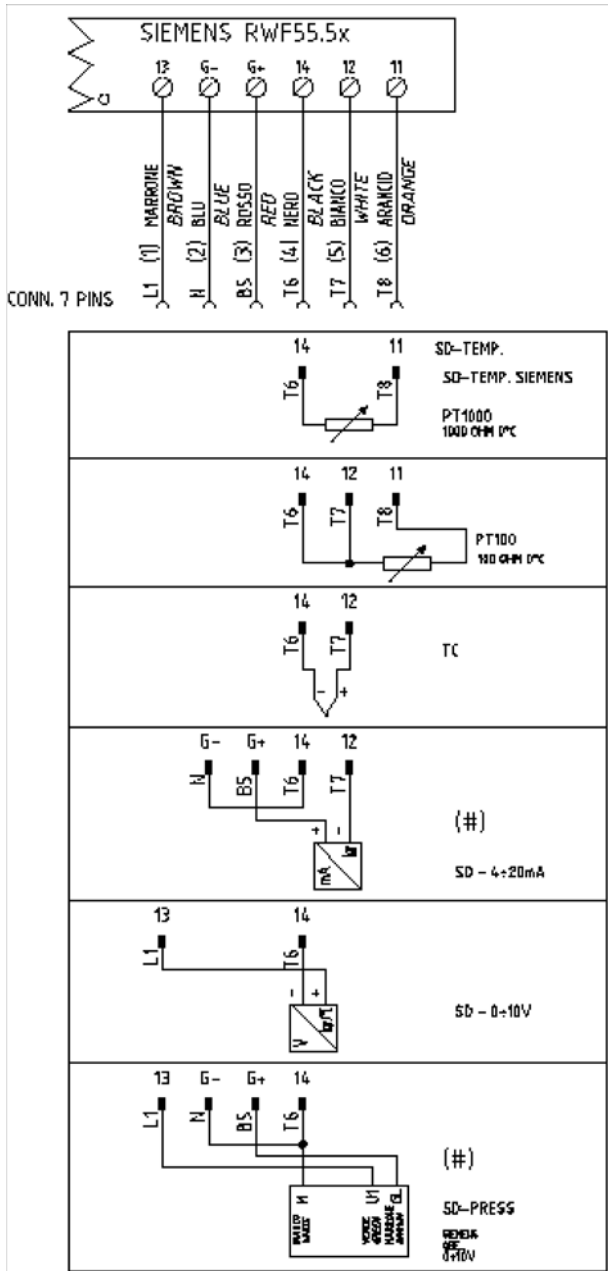

With terminals version

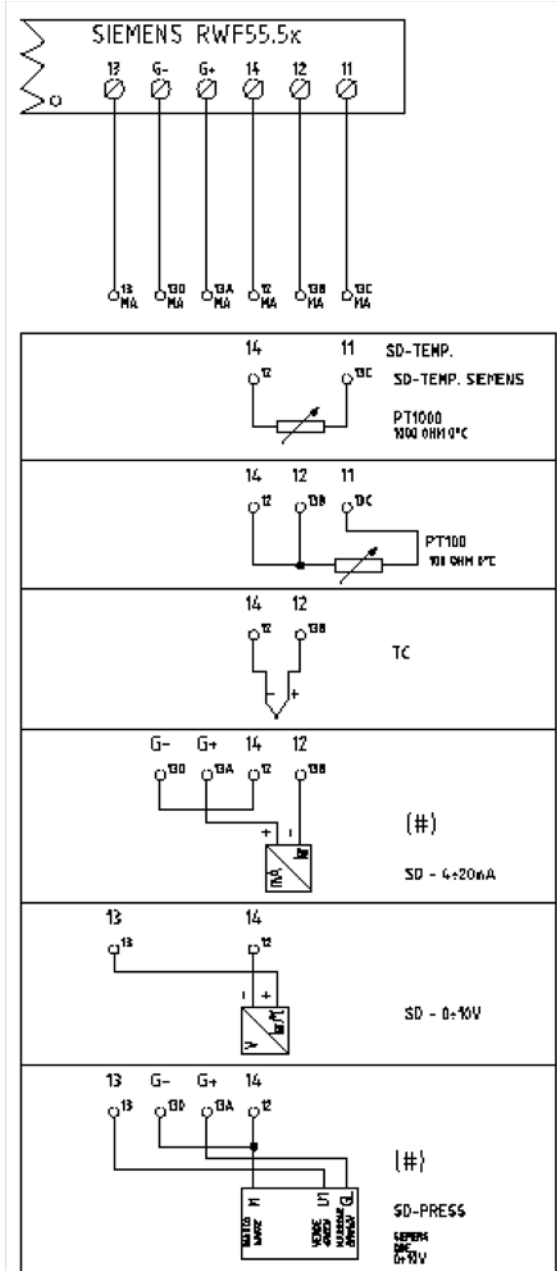

Correspondences bornes entre RWF55.5x y RWF40.0x0 Matches terminals between RWF55.5x and RWF40.0x0

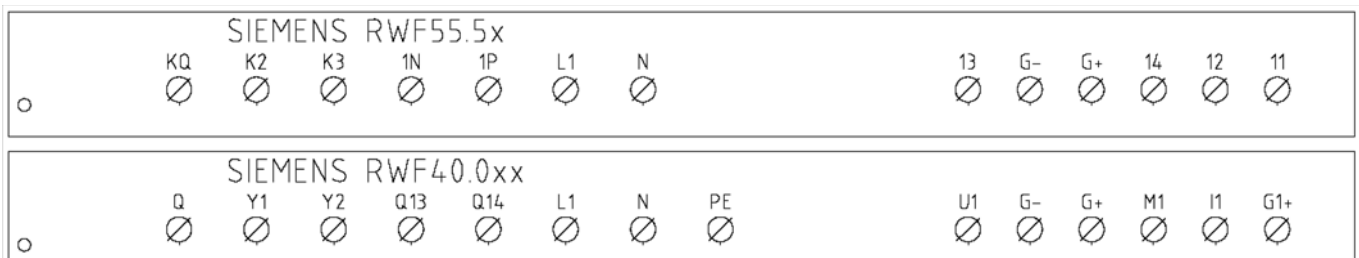

**Parameters summarising for RWF55.xx :**

Navigation menu	ConF					ConF			PArA						Opr
	Inp					Cntr		diSP							Opr
	Inp1														
	SEn1	OFF1	SCL	SCH	Unit	SPL	SPH	dECP	Pb. 1	dt	rt	tt	HYS1 (*)	HYS3 (*)	SP1 (*)
Siemens QAE2120...	6	0	needless	needless	1	30	95	1	10	80	350	(#)	-5	5	80 °C
Siemens QAM2120..	6	0	needless	needless	1	0	80	1	10	80	350	(#)	-2,5	2,5	40°C
Pt1000 (130°C max.)	4	0	needless	needless	1	30	95	1	10	80	350	(#)	-5	5	80°C
Pt1000 (350°C max.)	4	0	needless	needless	1	0	350	1	10	80	350	(#)	-5	10	80°C
Pt100 (130°C max.)	1	0	needless	needless	1	0	95	1	10	80	350	(#)	-5	5	80°C
Pt100 (350°C max)	1	0	needless	needless	1	0	350	1	10	80	350	(#)	-5	10	80°C
Probe4+20mA / 0+1,6bar	16	0	0	160	needless	0	160	0	5	20	80	(#)	0	20	100 kPa
Probe4+20mA / 0+3bar	16	0	0	300	needless	0	300	0	5	20	80	(#)	0	20	200 kPa
Probe 4+20mA / 0+10bar	16	0	0	1000	needless	0	1000	0	5	20	80	(#)	0	50	600 kPa
Probe 4+20mA / 0+16bar	16	0	0	1600	needless	0	1600	0	5	20	80	(#)	0	80	600 kPa
Probe 4+20mA / 0+25bar	16	0	0	2500	needless	0	2500	0	5	20	80	(#)	0	125	600 kPa
Probe 4+20mA / 0+40bar	16	0	0	4000	needless	0	4000	0	5	20	80	(#)	0	200	600 kPa
Probe 4+20mA / 0+60PSI	16	0	0	600	needless	0	600	0	5	20	80	(#)	0	30	300 (30PSI)
Probe4+20mA / 0+200PSI	16	0	0	2000	needless	0	2000	0	5	20	80	(#)	0	75	600 (60PSI)
Probe4+20mA / 0+300PSI	16	0	0	3000	needless	0	3000	0	5	20	80	(#)	0	120	600 (60PSI)
Siemens QBE2002 P4	17	0	0	400	needless	0	400	0	5	20	80	(#)	0	20	200 kPa
Siemens QBE2002 P10	17	0	0	1000	needless	0	1000	0	5	20	80	(#)	0	50	600 kPa
Siemens QBE2002 P16	17	0	0	1600	needless	0	1600	0	5	20	80	(#)	0	80	600 kPa
Siemens QBE2002 P25	17	0	0	2500	needless	0	2500	0	5	20	80	(#)	0	125	600 kPa
Siemens QBE2002 P40	17	0	0	4000	needless	0	4000	0	5	20	80	(#)	0	200	600 kPa
Signal 0+10V	17	0	needless	needless	needless	needless	needless	needless	5	20	80	(#)			
Signal 4+20mA	16	0	needless	needless	needless	needless	needless	needless	5	20	80	(#)			

**NOTE:**

(#) tt – servo control run time

SQL33 ; STM30; SQM10; SQM40; SQM50; SQM54 = 30 (secondi) - STA12B3.41; SQN30.251; SQN72.4A4A20 = 12 (secondi)

(\*)These values are factory set - values must be set during operation at the plant based on the real working temperature/pressure value.

**WARNING :**

With pressure probes in bar the parameters SP1, SCH, SCL, HYS1, HYS3 must be set and displayed in kPa (kilo Pascal); 1bar = 100,000Pa = 100kPa.

With pressure probes in PSI the parameters SP1, SCH, SCL, HYS1, HYS3 must be set and displayed in PSI x10 (example: 150PSI > I display 1500).

## APPENDIX: PROBES CONNECTION

To assure the utmost comfort, the control system needs reliable information, which can be obtained provided the sensors have been installed correctly. Sensors measure and transmit all variations encountered at their location.

Measurement is taken based on design features (time constant) and according to specific operating conditions. With wiring run in raceways, the sheath (or pipe) containing the wires must be plugged at the sensor's terminal board so that currents of air cannot affect the sensor's measurements.

### Ambient probes (or ambient thermostats)

#### Installation

The sensors (or room thermostats) must be located in reference rooms in a position where they can take real temperature measurements without being affected by foreign factors.

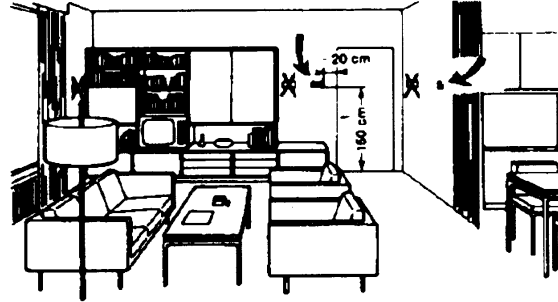
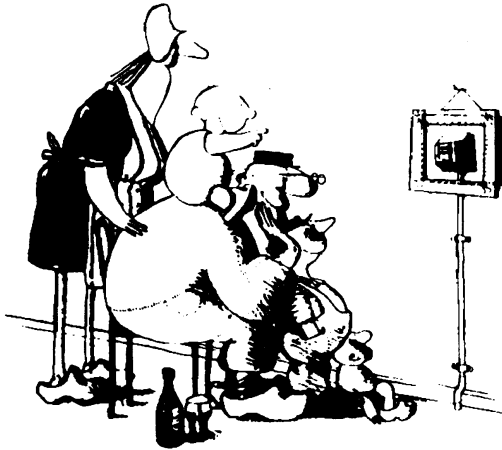

#### Outside probes (weather) Installation

In heating or air-conditioning systems featuring adjustment in response to outside temperature, the sensor's positioning is of paramount importance.

#### It's good to be admired ...even better to be effective

Heating systems: the room sensor must not be installed in rooms with heating units complete with thermostatic valves. Avoid all sources of heat foreign to the system.

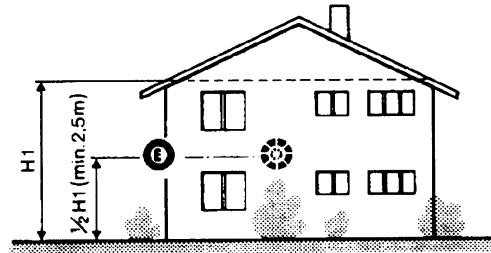
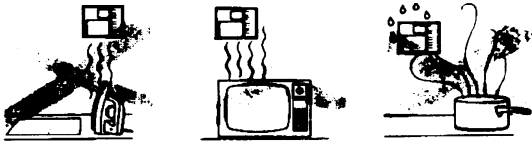

**General rule:** en on the outer wall of the building where the living rooms are, never on the south-facing wall or in a position where they will be affected by morning sun. If in any doubt, place them on the north or north-east façade.

#### Positions to be avoided

#### Location

On an inner wall on the other side of the room to heating units height above floor 1.5 m, at least 1.5 m away from external sources of heat (or cold).

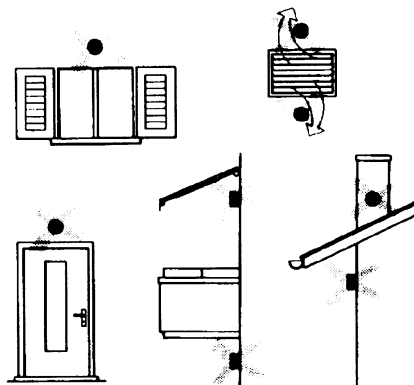
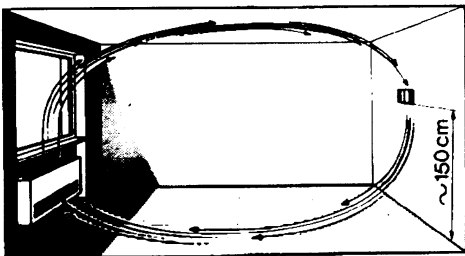

#### Installation position to be avoided

near shelving or alcoves and recesses, near doors or windows, inside outer walls exposed to solar radiation or currents of cold air, on inner walls with heating system pipes, domestic hot water pipes, or cooling system pipes running through them.

Avoid installing near windows, vents, outside the boiler room, on chimney breasts or where they are protected by balconies, cantilever roofs .

**The sensor must not be painted (measurement error) .**

**Duct or pipe sensors**

**Installing temperature sensors**

For measuring outlet air:

"after delivery fan or

"after coil to be controlled, at a distance of at least 0,5 m

For measuring room temperature:

"before return air intake fan and near room's return airintake.

For measuring saturation temperature: after mist eliminator.

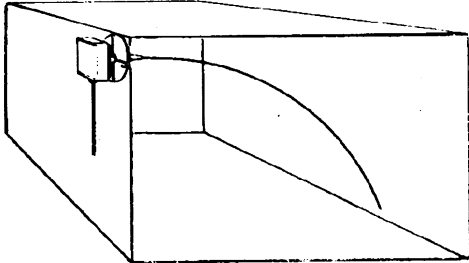

Bend 0.4m sensor by hand (never use tools) as illustrated .

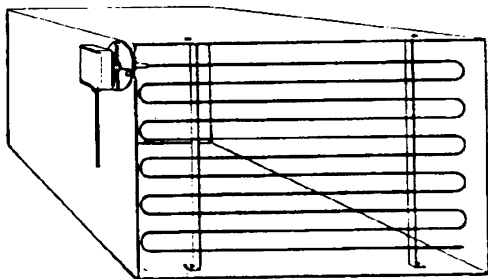

Use whole cross-section of duct, min. distance from walls 50 mm, radius of curvature 10 mm for 2m or 6m sensors

**Installing combined humidity sensors**

As max. humidity limit sensor on outlet (steam humidifiers) .

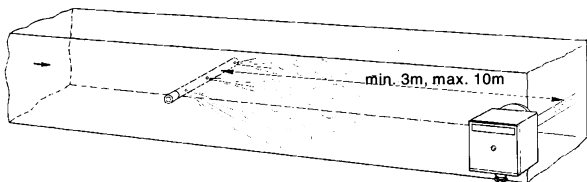

**Installing pressure sensors**

A - installation on ducts carrying fluids at max. temperature 80°C

B - installation on ducts at temperature over 80°C and for refrigerants

C - installation on ducts at high temperatures :

· "increase length of siphon

"place sensor at side to prevent it being hit by hot air coming from the pipe.

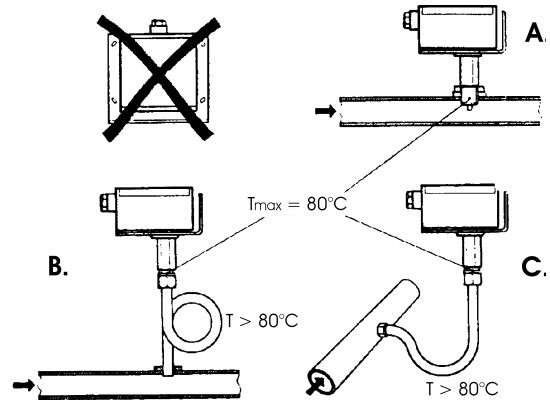

**Installing differential pressure sensors for water**

Installation with casing facing down not allowed.

With temperature over 80°C, siphons are needed.

To avoid damaging the sensor, you must comply with the following instructions :

when installing: make sure pressure difference is not greater than the value permitted by the sensor

when there are high static pressures, make sure you insert shutoff valves A-B-C.

**Putting into operation**

Start disable

1=open C1=open C

2=open A2=close B

3=open B3=close A

4= close C

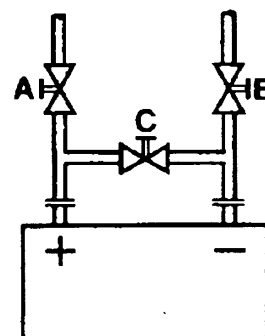

## Immersion or strap-on sensors

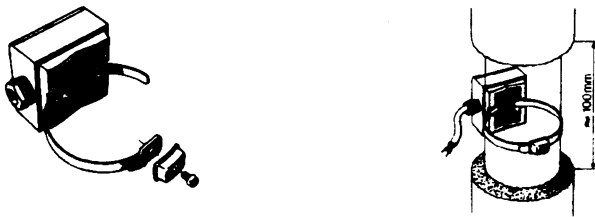
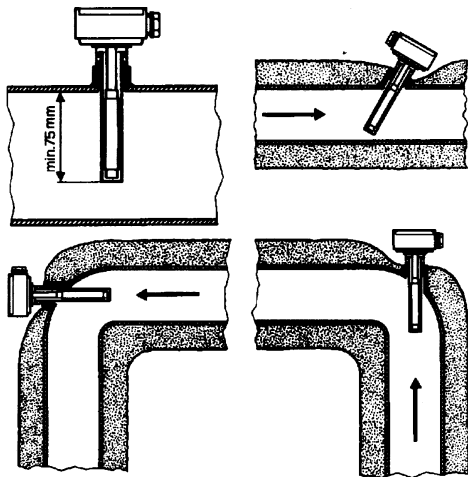

### Placing the probes (QAD22.../QAE21.../QAP21.../RCA...)

#### With pumps on outlet

with 3 ways valves / with 4 ways valves

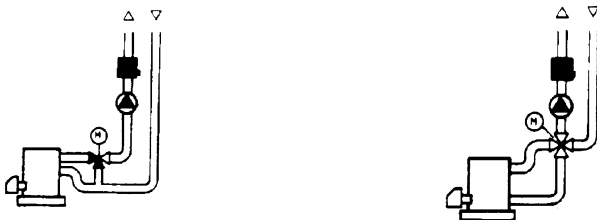

Panel system / burner control

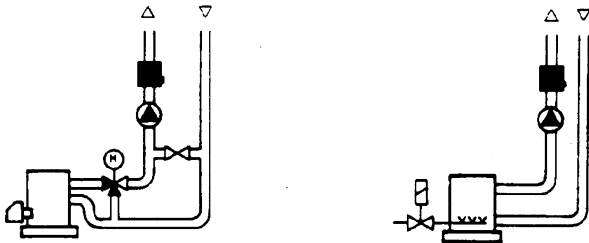

#### With pumps on return

with 3 ways valves / with 4 ways valves



### Immersion probes installation

Sensors must be installed on the stretch of pipe in which fluid circulates all the time.

The rigid stem (sensing element doing the measuring) must be inserted by at least 75mm and must face the direction of flow.

Recommended locations: on a bend or on a straight stretch of pipe but tilted by 45° and against the flow of fluid.

Protect them to prevent water from infiltrating (dripping gates, condensation from pipes etc.) .

### Installing QAD2.. strap-on sensors

Make sure fluid is circulating in the chosen location.

Eliminate insulation and paintwork (including rust inhibitor) on a min. 100mm length of pipe.

Sensors come with straps for pipes up to 100 mm in diameter .

### Strap-on or immersion sensors?

#### QAD2.. strap-on sensors

Advantages :

- 10 sec. time constant
- Installed with system running (no plumbing work)
- Installation can be changed easily if it proves incorrect

ΠLimits:

- Suitable for pipe diameters max. 100 mm
- Can be affected by currents of air etc.

#### QAE2... immersion sensors

Advantages:

- Measure "mean" fluid temperature
- No external influence on measurement such as: currents of air, nearby pipes etc.

Limits:

- Time constant with sheath: 20 sec.
- Hard to change installation position if it proves incorrect

Installing differential pressure probes for air

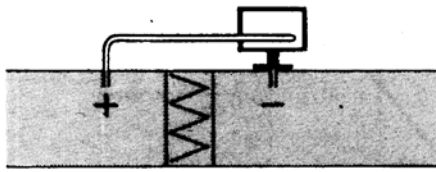

A - Control a filter (clogging)

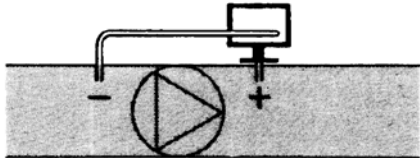

B - Control a fan (upstream/downstream)

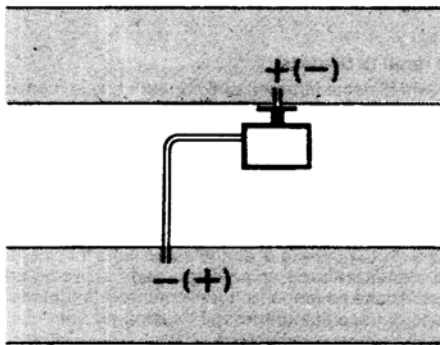

C - Measurement of difference in pressure between two ducts

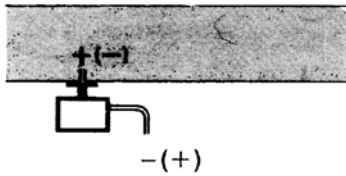

D - Measurement of difference in pressure between two rooms or of inside of duct and outside

Basic principles

Measuring static pressure (i.e. pressure exerted by air on pipe walls)

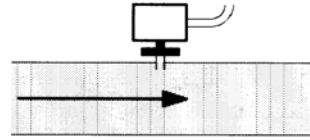

Measuring dynamic pressure

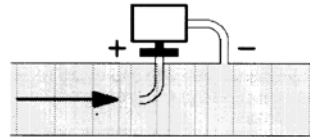

$$P_d = \frac{\gamma v^2}{2g}$$

Legend

- y Kg/m<sup>3</sup>, specific weight of air
- q m/s, air speed
- g 9.81 m/s<sup>2</sup> gravity acceleration
- P<sub>d</sub> mm C.A., dynamic pressure

Measuring total pressure

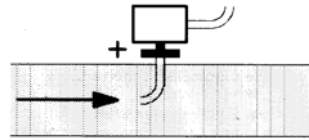



---

Note: Specifications and data subject to change. Errors and omissions excepted.