

حارقات الغاز



سلسلة NGX

دليل التركيب - الصيانة - الإستخدام

سيب أونيجاز

تحذيرات

يتم توفير هذا الدليل كجزء لا يتجزأ وأساسياً للمنتج ويجب أن تسلم إلى المستخدم. المعلومات الواردة في هذا القسم هي مكرسة إلى كل من المستخدم وإلى العاملين المحترفين بعد التركيب والصيانة

و سوف يسهل البحث عن مزيد من المعلومات حول قيود التشغيل و الاستخدام، في القسم الثاني من هذا الدليل. ونحن نوصي بشدة لقراءته. احتفظ بهذا الدليل بعناية للمستقبل.

الجزء الأول : التركيب

الميزات العامة

و تتميز هذه السلسلة من الحارقات بالعروض العالية والعرض في منحنيات الأداء، وعند الضغط في غرفة الاحتراق عالية. وتقدم أيضا مع غيرها من الميزات وظيفية هامة : هناك المقاييس التي يمكن توصيلها بسهولة الى المرجل ، والى الكشف عن تحقيقات ، أحد المكونات الضغط في غرفة الاحتراق ، وتقام جميع المكونات الميكانيكية على طبق من ذهب التي يمكن اتخاذها بسرعة لإيقاف الصيانة. الرأس هو قابل للتعديل عن طريق برغي تخرج. يمكن تركيبه القطار الغاز إما على الجانب الأيمن أو على الجانب الأيسر

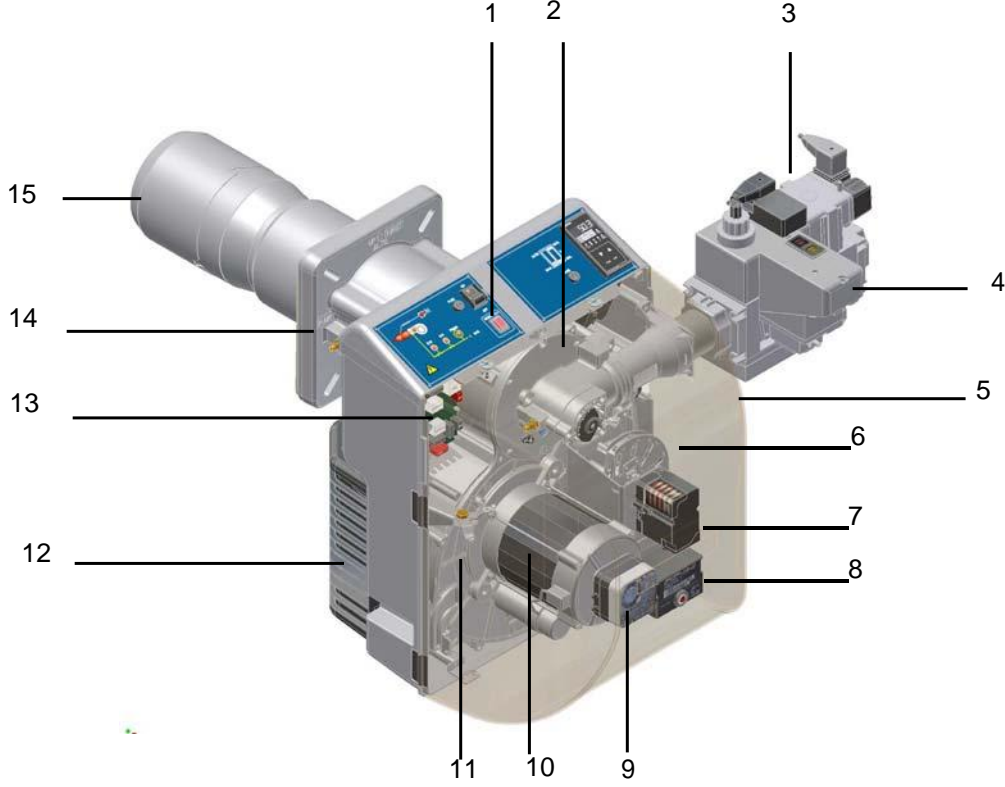

الشكل 1

- 1 لوحة التحكم مع تبديل بدء التشغيل
- 2 رأس الاحتراق (بالداخل)
- 3 مجموعة صمامات الغاز
- 4 تثبيت نظام الغاز
- 5 الغطاء
- 6 ضبط الممكن (مزدوج المرحلة ، الشعلات التدريجية وتحويل بالكامل)
- 7 المحرك (المزدوج المرحلة ، الشعلات التدريجية وتحويل بالكامل)
- 8 علب التحكم
- 9 مفتاح ضغط الهواء
- 10 مروحة المحرك
- 11 لوحة الشعلة
- 12 كمية الهواء
- 13 اللوحات الإلكترونية المطبوعة
- 14 شفة
- 15 أنبوب النفخ

الغاز القادمة من خط العرض، يمر عبر مجموعة الصمامات المتوفرة مع التصفية والاستقرار. هذا يضمن قوادة واحدة للضغط في حدود الاستخدام. في المرحلة المزدوج، أو الشعلات التدريجية وتحويل بالكامل ، والمحرك الكهربائي (7) ، التي تتحرك نسبيا مثبت الهواء و صمامة الغاز ، يستخدم ضبط التكيف مع شكل متغير. هذا يسمح لتعظيم في سبيل فصل بقدر منطقة الشعلة الاستفادة من قيم غاز المداخل ، والحصول على كفاءة الاحتراق. رأس الاحتراق (2) يحدد المواقع الإخراج الموقد. يتم توجيه الوقود (الغاز والبتترول والغاز ، النفط الثقيل) في غرفة الاحتراق.

لوحة التحكم وضعت على جانب الأمامي للموقد ، وتظهر كل مرحلة التشغيل.

النوع	قوة المحرك – كوات
 NGX35-NGX70	21-65
 NGX120-NGX200	35-150
 NGX280-NGX350 NGX400-NGX550	60-490
 LX60-LX65-LX72	165-1040

مواصفات الشعلات

تحديد نموذج الحارق

ويتم تحديد الشعلات حسب نوع وطراز الموقد. يوصف الشعلة تحديد النموذج على النحو التالي

نوع NG550 طراز	M-. PR. S. * A. 0. 50
(1)	(2) (3) (4) (5) (6) (7) (8)
نموذج الحارق (1)	حارق ذو غاز طبيعي – NG حارق L.P.G. – LG حارق Low NOx – NGX
وقود (2)	غاز طبيعي – M LPG – L
العملية (3)	طابق واحد – TN تجريبي – PR طابق مزدوج – AB تحويل بالكامل – MD
أنبوب النفخ (4)	عادي – S ممدد – L
الدولة الموجه إليها (5)	أنضهر لوحة البيانات
نسخة الحارق (6)	عادي – A
المعدات (7)	0 = صمامات الغاز 2 1 = نضام تثبيت الغاز + صمامات الغاز 2 7 = الحد الأقصى لتبديل ضغط الغاز + صمامات الغاز 2 8 = الحد الأقصى لتبديل + نضام تثبيت الغاز + صمامات الغاز 2
ربط الغاز (8)	25 = Rp1 32 = Rp1"1/4 40 = Rp1"1/2

NG550 - LG550 طابق واحد



NG550 - LG550 تدريجي/طابق مزدوج



NGX550 Low NOx حارق

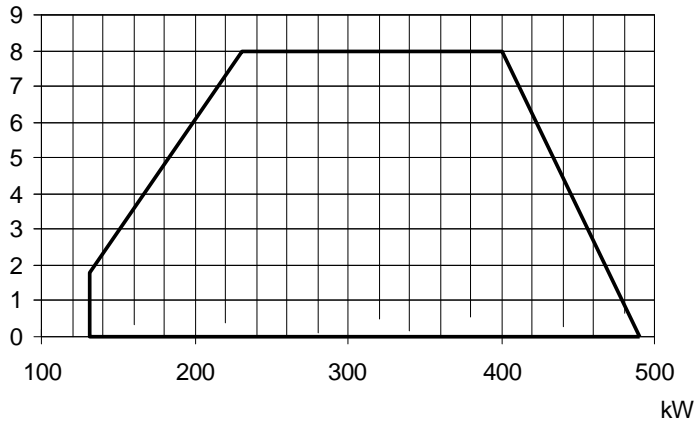

للحصول على المداخلات بالكيلو كالوري في الساعة اضرب الكيلوات في 860

منحنيات الضغط في شبكة الغاز

حارق ذو غاز طبيعي

طابق واحد NG550

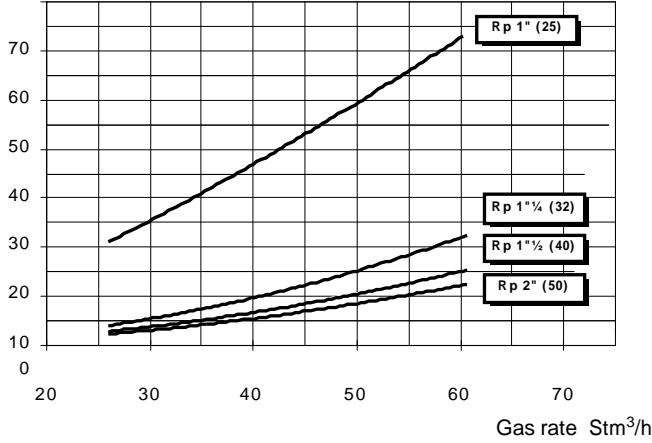

تدریجی/طابق مزدوج NG550

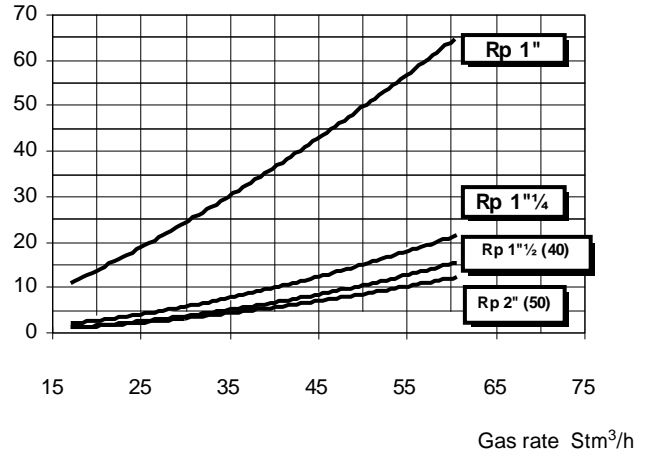

حارقات نوع L.P.G.

طابق واحد LG550 L-TN..25

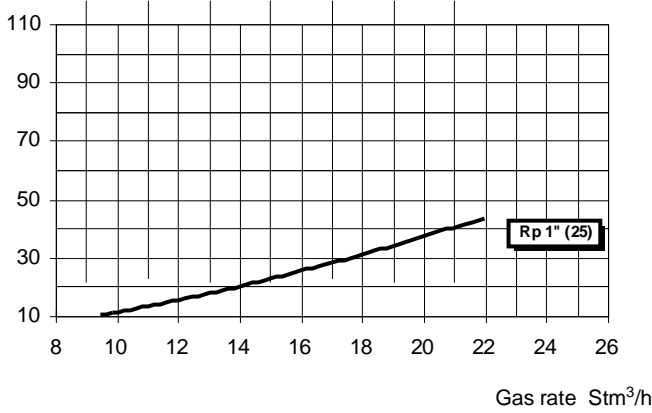

طابق واحد LG550 L-TN..32/40/50

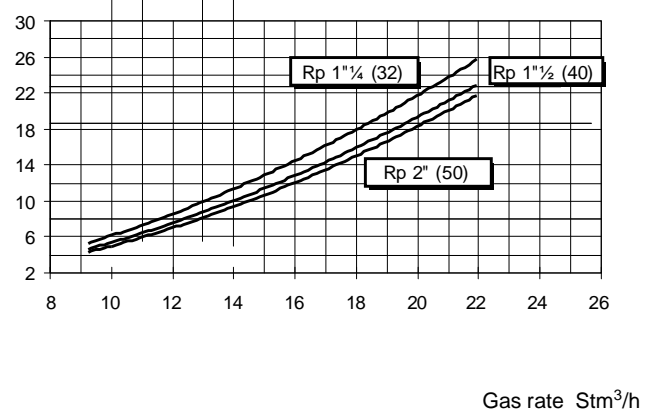

تدریجی/طابق مزدوج LG550 L-PR..

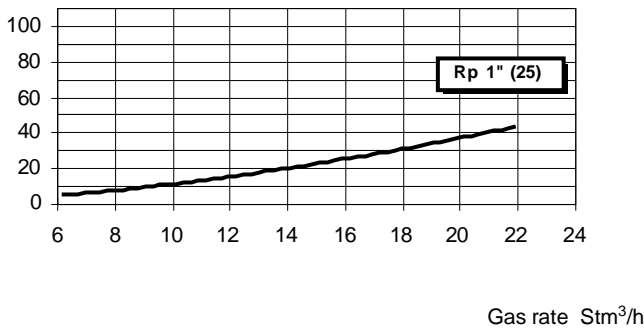

تدریجی/طابق مزدوج LG550 L-PR..

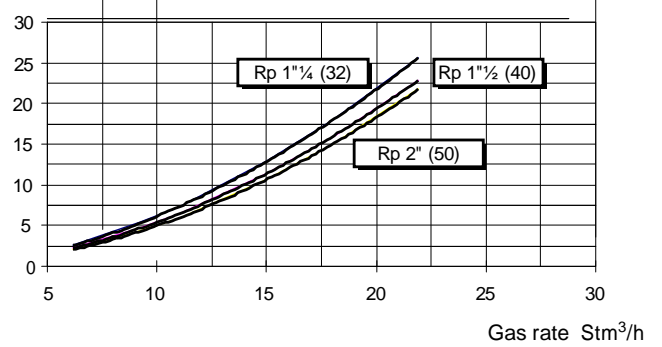

حارقات Low NOx

تدریجی/طابق مزدوج NGX550

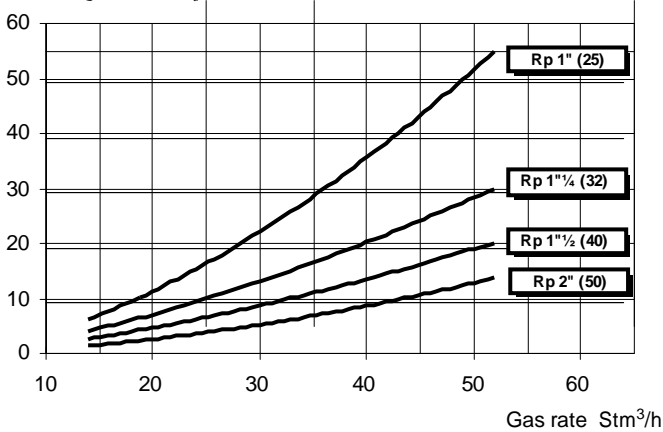

الأبعاد الكلية (مم)
الحارقات العادية

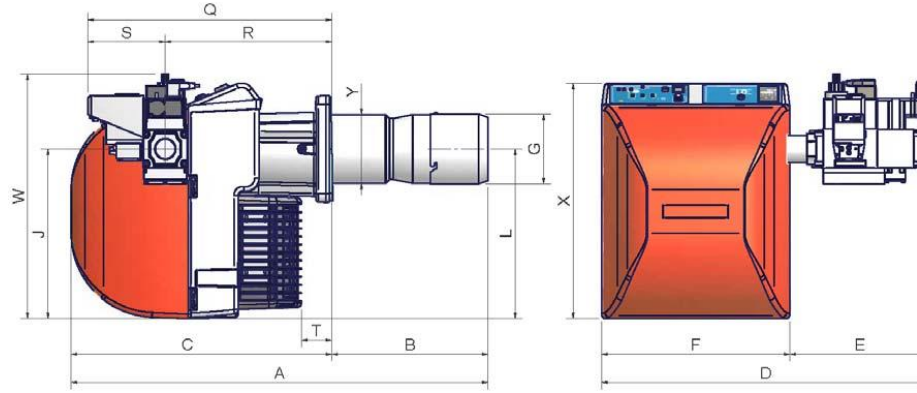

	DN	A(S*)	A(L*)	B(S*)	B(L*)	C	D ±5mm	E ±5mm	F	G	H	J	K	L	M	N	Omin	Omax	P	Q	R	S	T	W	X	Y
NG/LG550	25/32	843	943	253	353	590	671	245	426	165	178	384	241	384	M10	247	157	192	174	552	377	175	69	543	533	155
NG/LG550	40	843	943	253	353	590	744	318	426	165	178	384	241	384	M10	247	157	192	174	552	377	175	69	553	533	155
NG/LG550	50	843	943	253	353	590	744	318	426	165	178	384	241	384	M10	247	157	192	174	552	377	175	69	603	533	155

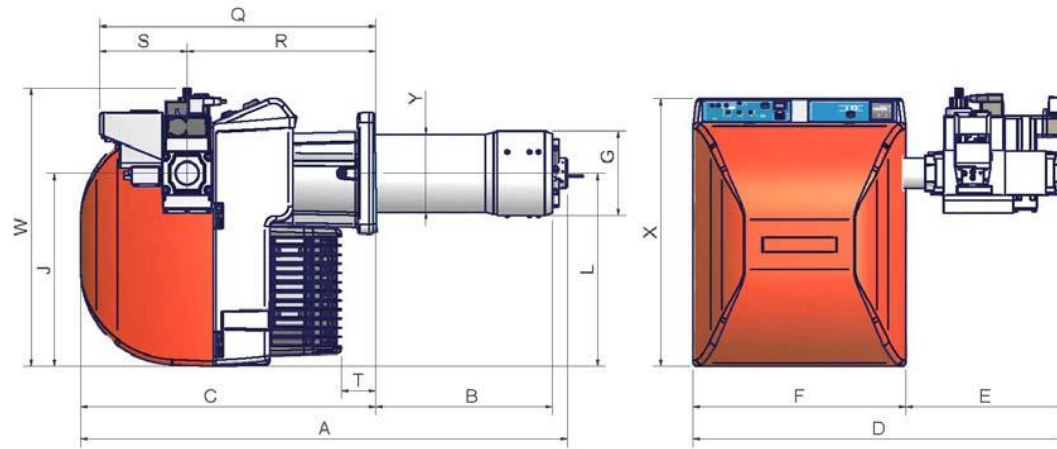

حارقات طراز Low NOx حارقات طراز Low NOx



	DN	A(S*)	A(L*)	B(S*)	B(L*)	C	D ±5mm	E ±5mm	F	G	H	J	K	L	M	N	Omin	Omax	P	Q	R	S	T	W	X	Y
NGX550	25/32	874	974	253	353	590	671	245	426	176	198	384	241	384	M10	247	157	192	174	552	377	175	69	543	533	168
NGX550	40	874	974	253	353	590	744	318	426	176	198	384	241	384	M10	247	157	192	174	552	377	175	69	553	533	168
NGX550	50	874	974	253	353	590	744	318	426	176	198	384	241	384	M10	247	157	192	174	552	377	175	69	603	533	168

الوصلات الكهربائية

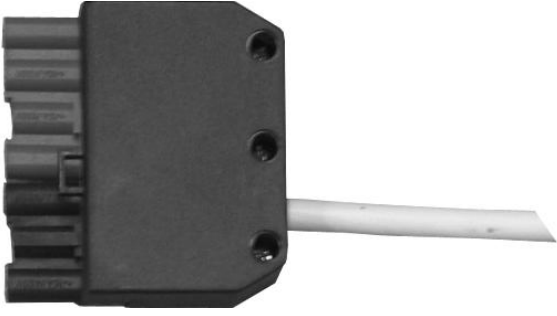
تحديد روابط التوصيل

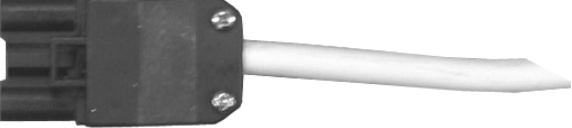
مصدر توصيل الموقد	 <p>رسم . 15</p>
توصيل الشعلة عالية/منخفضة حارق تدريجي	 <p>رسم . 16</p>
توصيل مروحة المحرك	 <p>رسم . 17</p>

هام : قبل تشغيل الموقد ، تأكد من ربط جميع الروابط كما هو موضح في المخططات



روابط الموقد ذو طابق واحد z

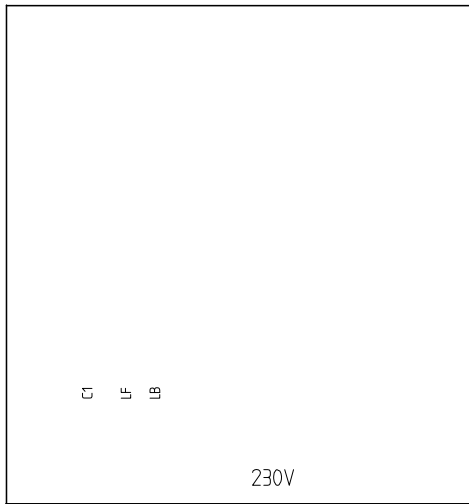
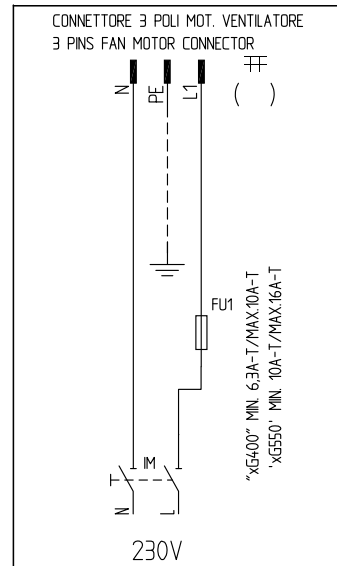

Fig. 18 - 7- أقطاب الروابط

Fig. 19 - أقطاب الروابط-3- المحرك الكهربائي



روابط الموقد التدريجي z

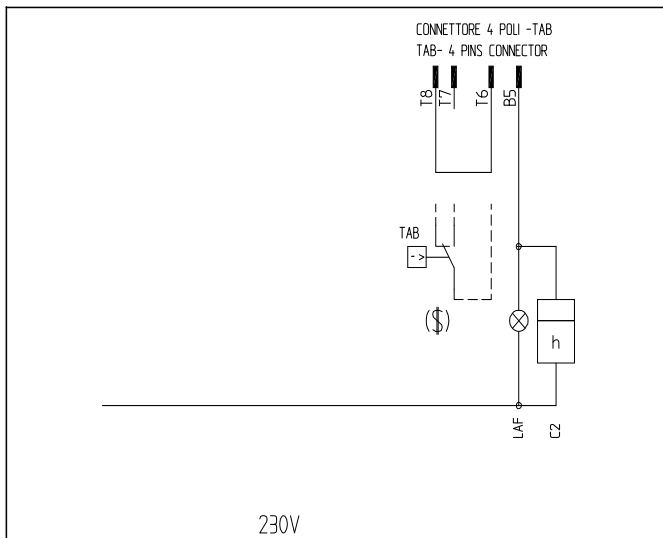
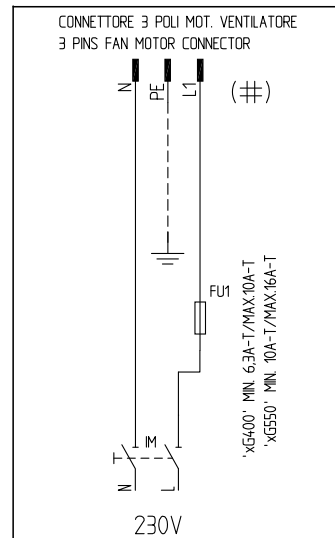
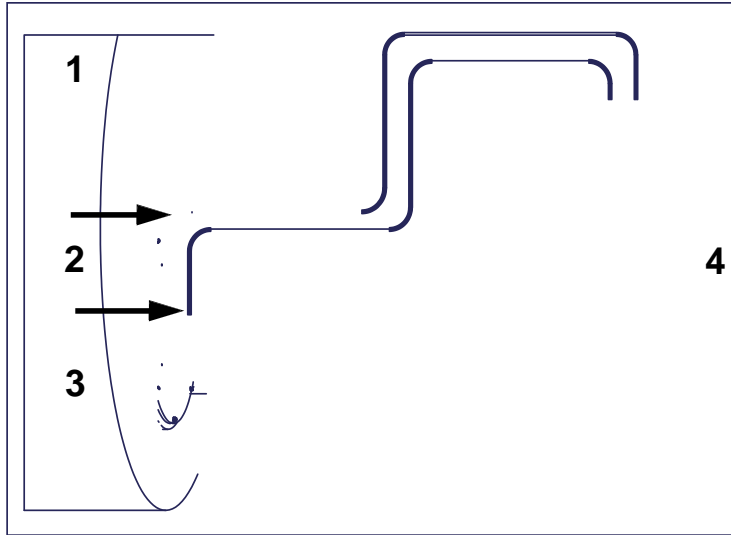

Fig. 20 - 4 أقطاب النهاية

Fig. 21 - أقطاب الروابط-3- المحرك الكهربائي



منحنيات الاحتراق ضغط رأس مقابل معدل تدفق الغاز



رسم . 24

المفتاح

- 1 المولد
- 2 منفذ الضغط على غرفة الاحتراق
- 3 منفذ ضغط الغاز على صمام فرائشة
- 4 مقياس الضغط التفاضلي

الجزء الثاني : العملية

القيود المفروضة على الإستخدام

الحارق هو جهاز صمم بالتدقيق لكي يعمل فقط بعد أن يتم ربطه بشكل صحيح مع مولد الحرارة (أومثال على المراجل ومولد هواء ساخن ، الفرن ، الخ) ، أي استخدام آخر يتعين غير سليم يعتبر بالتالي خطير.

لوحة مراقبة الشعلة

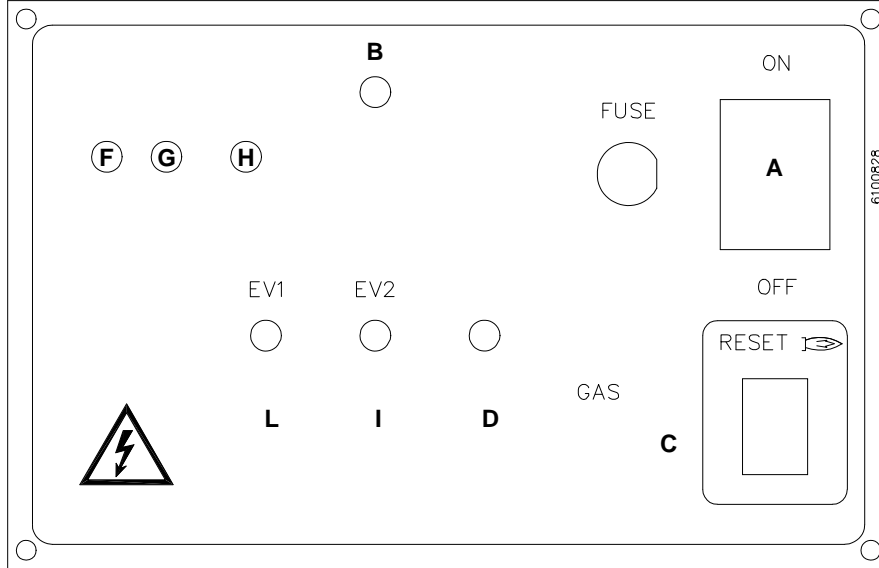

32. رسم

حارقات طابق واحد _ طابق مزدوج

VERSIONE ALTERNATIVA DI UNO SCHEMA DI AB "N" PROGRESSIVO "PR"
 "AB" HIGH-LOW SINGLE PROGRAM VERSION

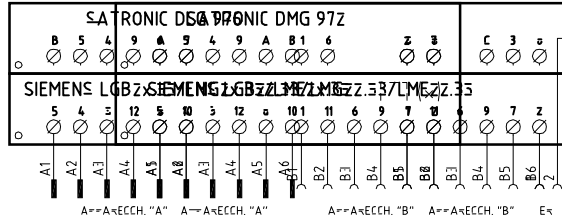
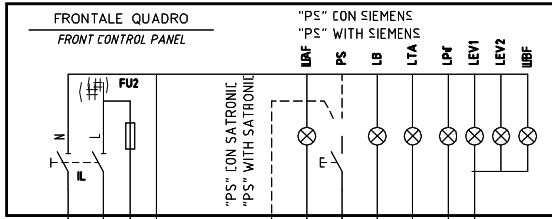

- SECONDO COMANDO SECONDA ARIA
 AIR DAMPER ACTUATOR
 STA13B0.56/83N30L
- I ALTA FIAMMA
 - II FINE
 - III SOSTA
 - IV STAND-BY
 - V BASSA FIAMMA
 - VI LOW FLAME
 - VII NON USATA
 - VIII NOT USED

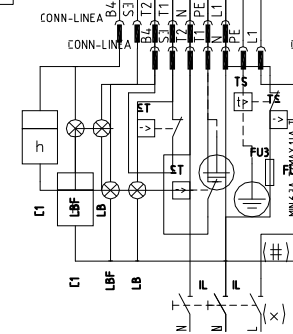
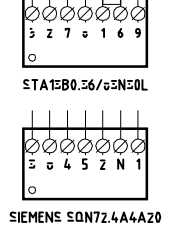
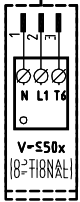
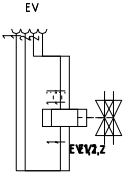
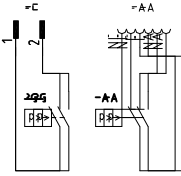
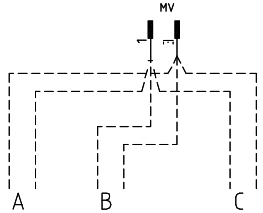
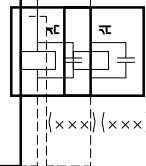
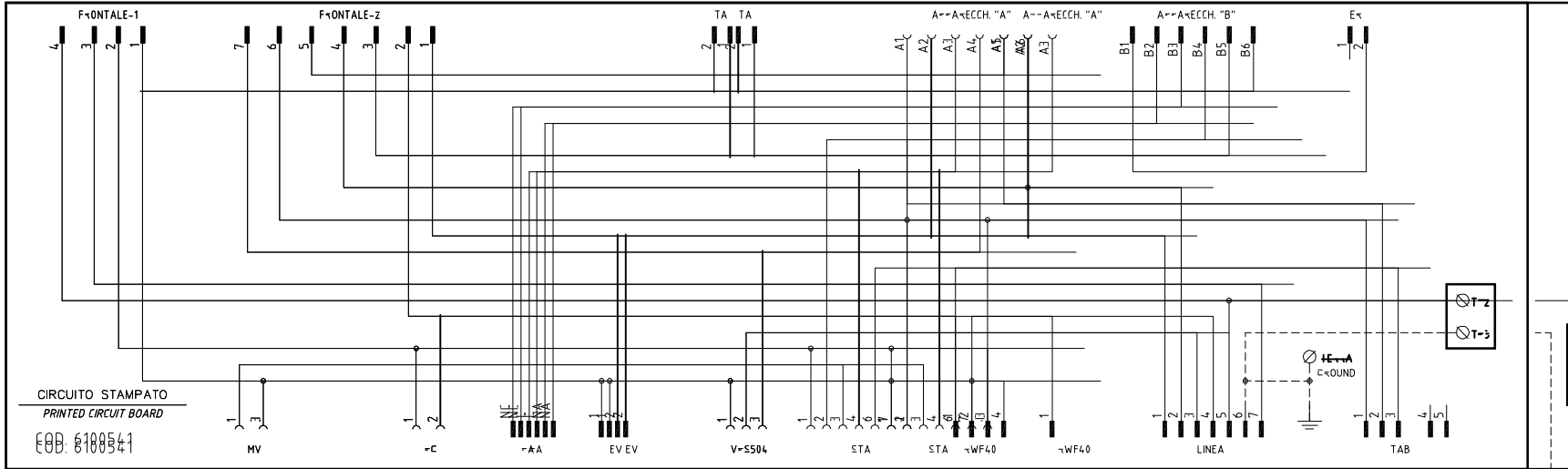

MOTORE VENTIL. 450W O 620W, FUZ = 6,3A F; MOTORE VENTIL. 370W, FUZ = 10A F
 FAN MOTOR 45=W OR 62=W, FUZ = 6,3A F; FAN MOTOR 37=W FUZ = 1=A F

FARE PONTE TRA I MORSETTI 7 E 9 SOLO CON LCBZ1330
 CONNECTION BETWEEN TERMINALS 7 AND 9 WITH LCBZ1.33= ONLY

230V 230V (XXX) SOLO CON ALIMENTAZIONE ELETTRICA SENZA NEUTRO

(#) MOTORE VENTIL. 450W O 620W, FUZ = 6,3A F; MOTORE VENTIL. 370W, FUZ = 10A F
 FAN MOTOR 45=W OR 62=W, FUZ = 6,3A F; FAN MOTOR 37=W FUZ = 1=A F

(XXX) SOLO CON ALIMENTAZIONE ELETTRICA SENZA NEUTRO
 WITH ELECTRIC SUPPLY WITHOUT NEUTRAL VERSION ONLY

(\$) SE USATO "TAB", TOGLIERE IL PONTE TRA I MORSETTI T6-T8
 IF USED "TAB", REMOVE THE BRIDGE BETWEEN TERMINALS T6-T8

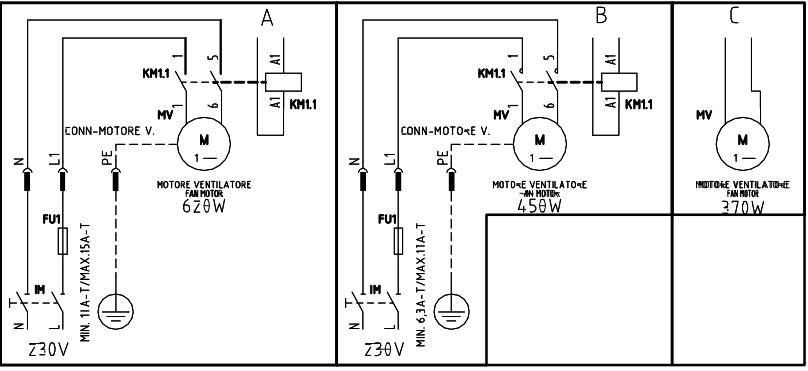

FRONTALE QUADRO
FRONT CONTROL PANEL

"PS" CON SIEMENS
"PS" WITH SIEMENS

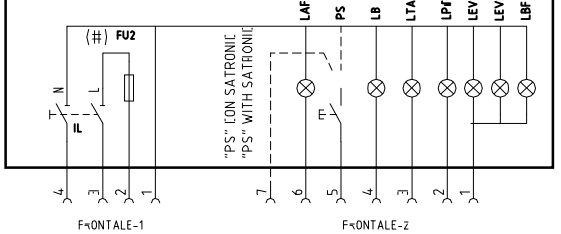

VERSIONE MODULANTE "MD"
"MD" MODULATING VERSION

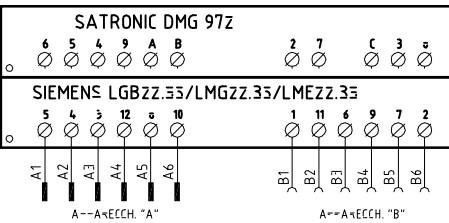

- SERVOCOMANDO SERRANDA ARIA
AIR DAMPER ACTUATOR
STA13B0.36/83N30L
- I ALTA FIAMMA
HIGH FLAME
 - II SOSTA
STAND-BY
 - IV BASSA FIAMMA
LOW FLAME
 - III NON USATA
NOT USED
- SERVOCOMANDO SERRANDA ARIA (ALTERNATIVO)
AIR DAMPER ACTUATOR (ALTERNATIVE)

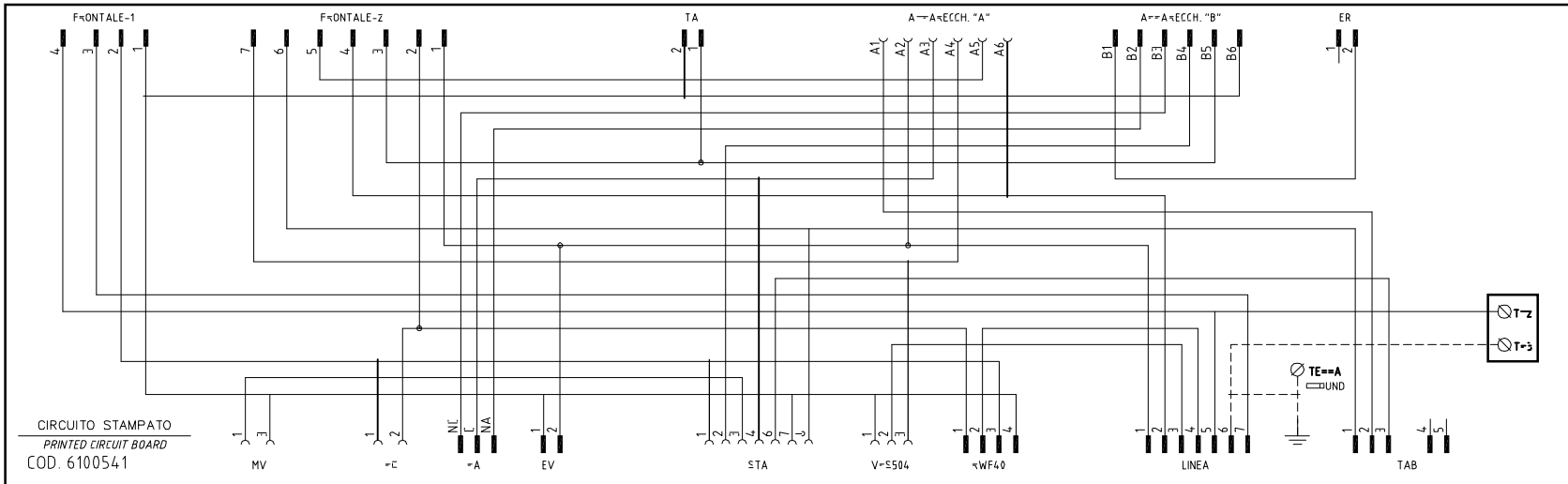

CIRCUITO STAMPATO
PRINTED CIRCUIT BOARD
COD. 6100541

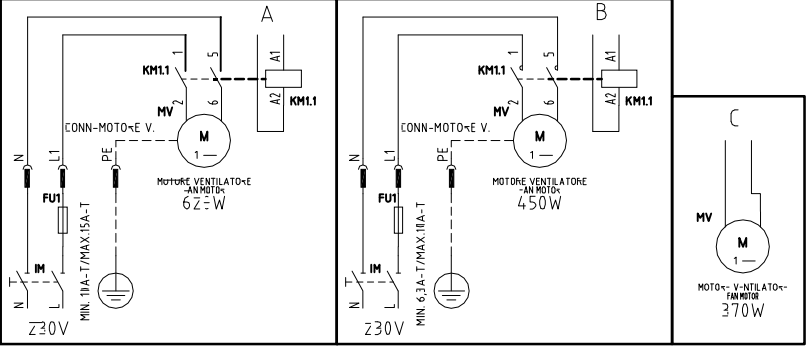
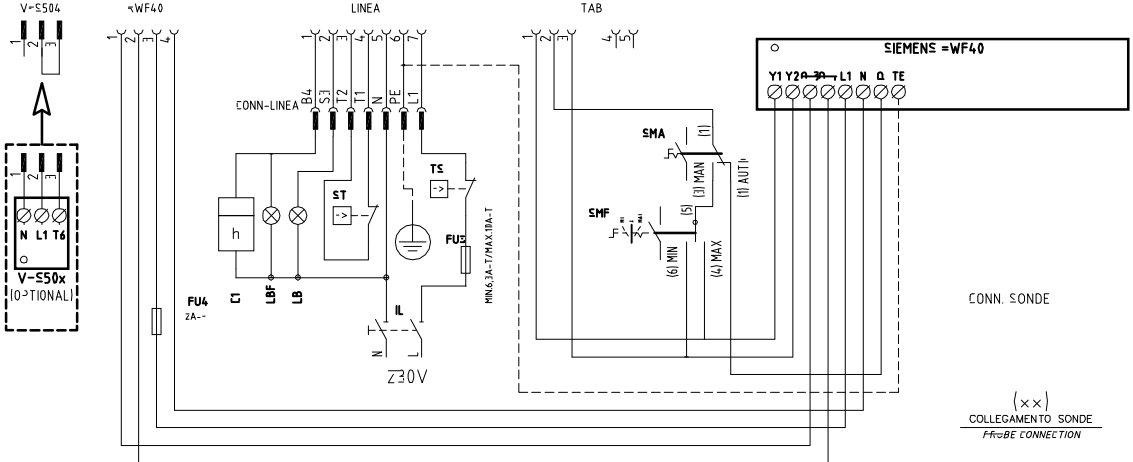
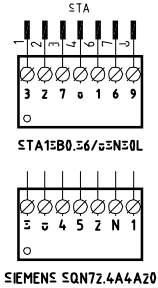
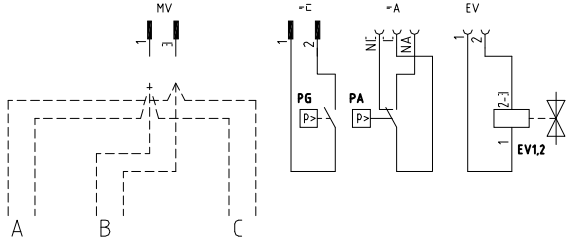

(#) MOTO=E VENTIL. 450W O 620W, FUZ = 6,3A F; MOTORE VENTIL. 370W, FUZ = 10A F
FAN MOTOR 45=W OR 62=W, FUZ = 6,3A F; FAN MOTOR 37=W FUZ = 1=A F

(x x x) SOLO CON ALIMENTAZIONE ELETTRICA SENZA NEUTRO
WITH ELECTRIC SUPPLY WITHOUT NEUTRAL VERSION ONLY

CONN. SONDE
(x x x)
COLLEGAMENTO SONDE
FR=BE CONNECTION

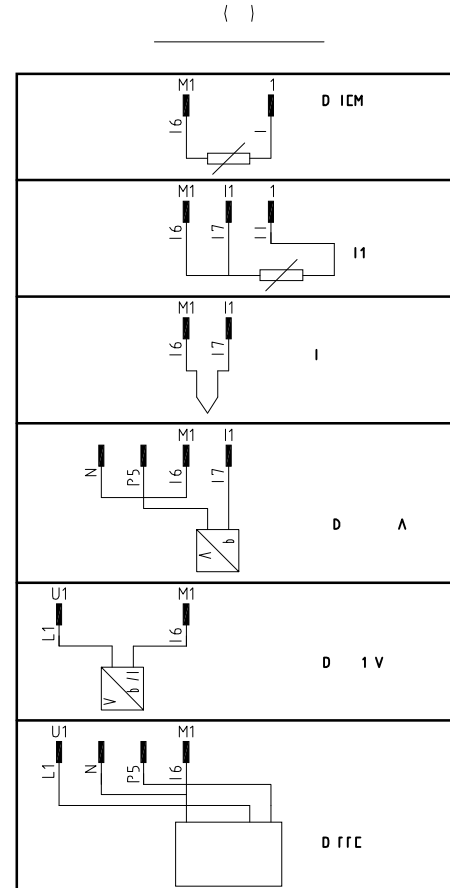
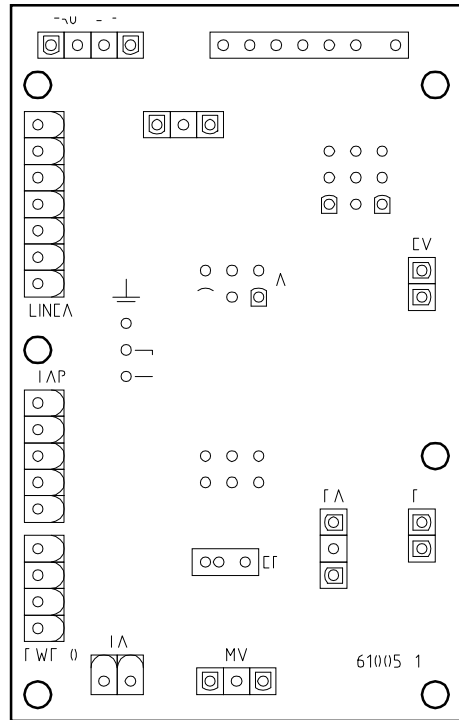

D	01/10/2008	3	4
P	01	3	
D N	18 - 163	SFGUF 3	IOIALF 3

I LA/ICM	FUNZI NC	FUNZI N
1	NIA GE PA A FIAMMA	L W FLAME TIME UNIEF
—	NIA GE ALIA FIAMMA	III II FLAME TIME UNIEF
C	ELEIIF D FIELEVAZI NE FIAMMA	FLAME DEIC II NELE IF DC
CV1	ELEIIF VALV LE A (FUFF VALV LE)	A ELE IF VALVE (F VALVE F UF)
FU1	FU IPILE LINEA M I GE VENIILAI GE	FAN M I F LINE FU E
FU	FU IPILE DI LINEA	LINE FU E
FU	FU IPILE DI LINEA	LINE FU E
FU	FU IPILE AU ILIAGI	AUXILIAR FU E
IL	INIEFGUII GE LINEA PFU IAI GE	PUFNEF LINE WII II
IM	INIEFGUII GE LINEA M I E VENIILAI GE	FAN M I F LINE WII II
I M11	NIAII GEM I GE VENIILAI GE	FAN M I F NIA I F
LAF	LAMF ADA E NALAZI NE ALIA FIAMMA PFU IAI GE	PUFNEF IN III II FLAME INDI AI F LI III
LP	LAMF ADA E NALAZI NE PL PFU IAI GE	INDI AI F LI III F F PUFNEF L I UI
LPG	LAMF ADA E NALAZI NE PA A FIAMMA PFU IAI GE	PUFNEF IN L W FLAME INDI AI F LI III
LEV1	LAMF ADA E NALAZI NE AF EF IUF A [CV1]	INDI AI F LI III F F ENIN F ELE IF VALVE [CV1]
LCV	LAMF ADA E NALAZI NE AF EF IUF A [CV]	INDI AI F LI III F F ENIN F ELE IF VALVE [CV]
LF	LAMF ADA E NALAZI NE FUNZI NAMENTI PFU IAI GE	INDI AI F LI III PUFNEF FEF AII N
L	LAMF ADA E NALAZI NE F E ENZA A INTICIE	INDI AI F LI III F F F E EN E F A IN IIIE NEI W FI
LIA	LAMF ADA E NALAZI NE I A F FMAI GE DIA EN I NE	I NIII N IFAN F FMEF INDI AI F LI III
LIA	LAMF ADA E NALAZI NE I A F FMAI GE DIA EN I NE	I NIII N IFAN F FMEF INDI AI F LI III
MV	M I GE VENIILAI GE	FAN M I F
FA	FFE IAI AGIA	MPU II N AIF FFE UFE WII II
F	FFE IAI A DI MINIMA FFE I NE	MINIMUM A FFE UFE WII II
F	FFE IAI A DI MINIMA FFE I NE	MINIMUM A FFE UFE WII II
F	FFE IAI A DI MINIMA FFE I NE	MINIMUM A FFE UFE WII II
F	FUL ANIE PL FIAMMA	L I UI FFE EIPUII N
F 1100	NDA DI IEM EGA IUG A	IEM EGA IUG E F F PE
F	IF UII F	F IF UII
AIF NI DL 976	AGF AGE IIIA IUG A NIF LL FIAMMA	NIF LP X
AIF NI DM 97	AGF AGE IIIA IUG A NIF LL FIAMMA	NIF LP X
D FFE	NDA DI FFE I NE	FFE UFE F F PE
D IEMF	NDA DI IEM EGA IUG A	IEM EGA IUG E F F PE
D 0 10V	IGA DUUI GEU IIA IN IEN I NE	IFAN DU EF V LIA E UI FUI
D 0 A	IGA DUUI GEU IIA IN FGENIE	IFAN DU EF UFFENI UI FUI
IEMEN L P /LM /LME	AGF AGE IIIA IUG A NIF LL FIAMMA	NIF LP X
IEMEN L P /LM /LME	AGF AGE IIIA IUG A NIF LL FIAMMA	NIF LP X
IEMEN FWF 0	GE LAI GEM DULANIE	PUFNEF M DULAI F
MA	ELEIIF GE MANUALE/AUI MAII	MANUAL/AUI MAII WII II
MF	ELEIIF GE MANUALE FUNZI NAMENTI MIN 0 MAX	MIN 0 MAX MANUAL FEF AII N WII II
—N7 A A 0	EFV MAND EFGANDA AGIA (ALIEFNAIIV)	AIF DAMFEF A IUA I F (ALIEFNAIIVE)
I	EFIE IEFM IAIIFFE IAI	EFIE F IIEFM IAI F FFE UFE WII IIE
I A1 P 0 6/ N 0L	EFV MAND EFGANDA AGIA	AIF DAMFEF A IUA I F
IA	IGA F FMAI GE DIA EN I NE	I NIII N IFAN F FMEF
IAP	IEFM IAI /FFE IAI ALIA PA A FIAMMA	III II L W IIEFM IAI /FFE UFE WII IIE
I	IEFM FFA	IIEFM UFE
I	IEFM IAI /FFE IAI DI I UGEZZA	AFEI IIEFM IAI F FFE UFE WII II
VF 50	NIF LL DI IENUIA VALV LE A (FII NAL)	A F F VIN IEM (FII NAL)

D	01/10/2008	4	3
P	01		
D N	18 - 163	SFGUF /	IOIALF 3

VERSIONE ALTA-BASSA FIAMMA / PROGRESSIVO CON RELE KAB DI SEZIONAMENTO
 HIGH-LOW / PROGRESSIVE VERSION WITH KAB SECTIONING RELAY
 Исполнение двухступенчатое / прогрессивное с разделительным реле «КАВ»

NNEII ΓC [] Γ LI
 [] Γ IN NNE I Γ
 [3] - TI IO IO IIII OI IIIITI IYIIII IAZIIM

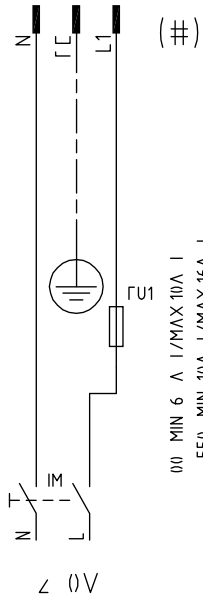

00 MIN 6 A I/MAX 10A I
 550 MIN 10A I/MAX 16A I

(#) C LU II Γ [x 50]
 C LUDED IYΓE [x 50]
 3A И I IO II IIII M TIIIA [xG350]

NNEII ΓC [7] Γ LI
 [7] Γ IN NNE I Γ
 [7] - III IO IO IIIII OI IIIIIIII II IIIII IAZIIM

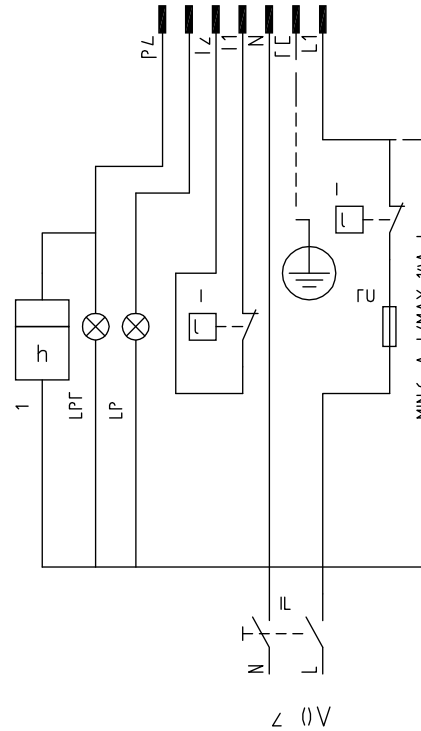

NNEII ΓC [4] Γ LI
 [4] Γ IN NNE I Γ
 [4] - III IO IO IIIII OI IIIIIIII II IIIII IAZIIM

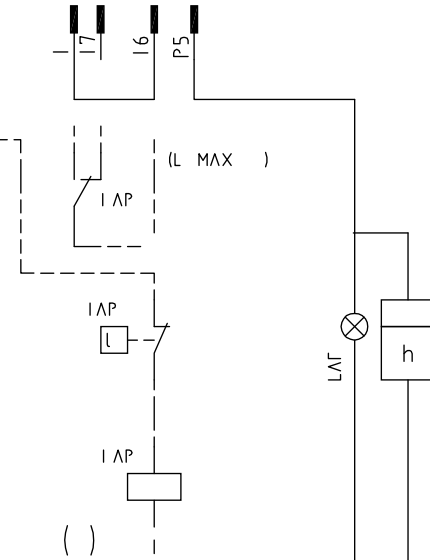

() C U LI I IIEΓEILΓ NIE IΓAIM Γ EIII 16 I
 IΓ U ED ΓEM VE IIIE PFID E PEIWEEN IEGMINAL 16 I
 I IIII IOII 3 II I IIIII IIIIIIII MIKI I IIIIMMI 16 18

D	26/06/2008	PPFC	FOGLIO
P	00	/	1
D N	TAB_1	SGUΓ	IOIALΓ
		2	1

SIGLA/ITEM	FUNZIONE	FUNCTION
1	NIA ΓE PA A ΓIAMMA	L W FLAME TIME UNIG
2	NIA ΓE ALIA ΓIAMMA	III II FLAME TIME UNIG
GU1	GU IPILE LINEA M I ΓE VENIILAI ΓE	GAN M I Γ LINE GU E
GU	GU IPILE LINEA P GU IA I ΓE	PUG NEG LINE GU E
IL	INIEΓΓUII ΓE LINEA P GU IA I ΓE	PUG NEG LINE WII II
IM	INIEΓΓUII ΓE LINEA M I ΓE VENIILAI ΓE	GAN M I Γ LINE WII II
I AP	ΓELE AU ILAΓI	AUXILIARY CELAY
LAG	LAMPADA E NALAZI NE ALIA ΓIAMMA P GU IA I ΓE	PUG NEG IN III II FLAME INDI AI Γ LI III
LP	LAMPADA E NALAZI NE PL P GU IA I ΓE	INDI AI Γ LI III Γ Γ PUG NEG L I UI
LPΓ	LAMPADA E NALAZI NE PA A ΓIAMMA P GU IA I ΓE	PUG NEG IN L W FLAME INDI AI Γ LI III
I	ΓEIE IEGM IAII/ΓE IAII	ΓEIE Γ IIEGM IA I Γ ΓE UGE WII IIE
I AP	IEGM IA I /ΓE IA I ALIA PA A ΓIAMMA	III II L W IIEGM IA I /ΓE UGE WII IIE
I	IEGM IA I /ΓE IA I DI I UΓEZZA	AGEIY IIEGM IA I Γ ΓE UGE WII II

SIGLA/ITEM	FUNZIONE	FUNCTION
C1	CONTATORE BASSA ΓIAMMA	- IET IKK IA_OB PABOTII PA MA IOM P IAMEIII
C2	CONTATORE ALTA ΓIAMMA	- IET IKK IA_OB PABOTII PA BO IYOM P IAMEIII
GU1	GUSIBILE LINEA MOTORE VENTILATORE	II IABIII III ΠI IO> I AIII TI IY IIIIII I BIII AT I I BI ITII I ITORA
GU3	GUSIBILE LINEA BPUCIATORE	Π IABKII ΠPEJO> PAIITE IY I IIII ΓOP E IKI
IL	INTERPOTTORE LINEA BPUCIATORE	BIIK IO IATE IY I IIII ΓOP E IKI
IM	INTERPOTTORE LINEA MOTORE VENTILATORE	BIIK IO IATE IY I IIII ΔBIIΓATE I I BEI TI I ITORA
YAB	PELE AUSILIARIO	B ΠOMOGATE IYIIE PE IE
LAG	LAMPADA SEGNALAZIONE ALTA ΓIAMMA BPUCIATORE	IΓIIA IYIIA I IAMP O IKA BO IYOMOΓO P IAMEIII ΓOP E IKI
LB	LAMPADA SEGNALAZIONE BLOCCO BPUCIATORE	-IΓIIA IYIIA I IAMP O IKA B IOKIPOBKI ΓOP E IKI
LBF	LAMPADA SEGNALAZIONE BASSA ΓIAMMA BPUCIATORE	-IΓIIA IYIIA I IAMP O IKA MA IOΓO P IAMEIII ΓOP E IKI
ST	SERIE TEPMOSTATI/PPRESSOSTATI	P I Δ TEPMO-TATOB/PE IE ΔAB IEIII I
TAB	TEPMOSTATO/PPRESSOSTATO ALTA-BASSA ΓIAMMA	T I P MO TAT/P I II ΔAB II III I BO IYOMOΓO/MA IOΓO P IAMI IIII
TS	TEPMOSTATO/PPRESSOSTATO DI SICUPEZZA	ΠPEJO> PAIITE IYIIII TEPMO-TAT/ PE IE ΔAB IEIII I

D	26/06/2008	PPFC	1	FOGLIO	2
P	00				
D N	TAB_1	SGUG	/	IOIALΓ	1

التذييل

LME11 رسم التوصيلات

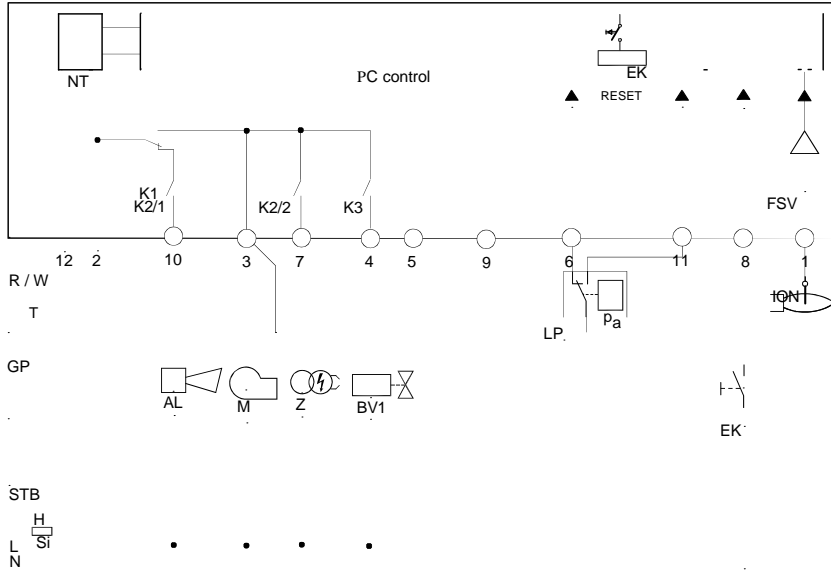

LME21 رسم التوصيلات

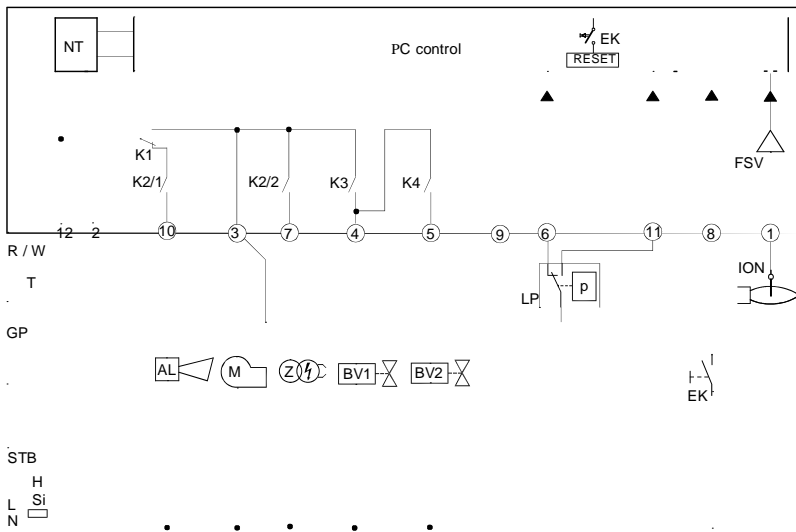

LME22 رسم التوصيلات

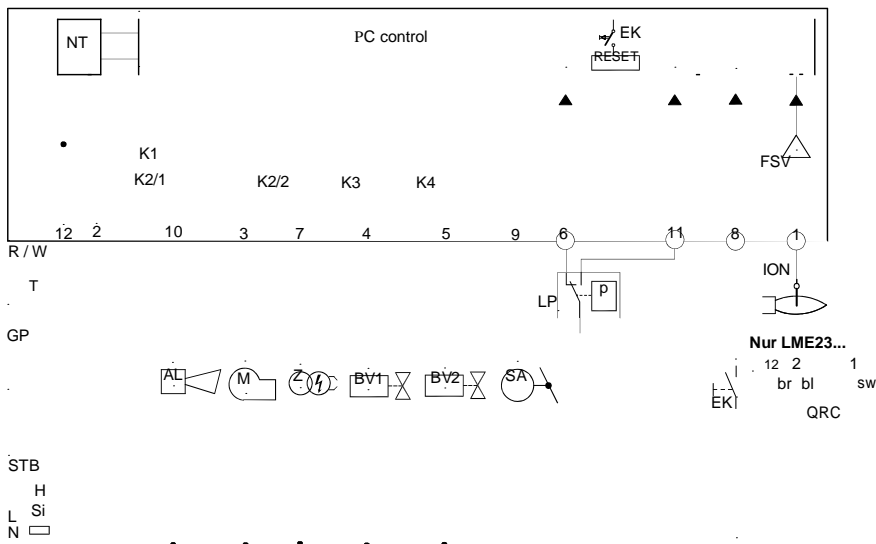

توصيات هامة لاستعمال الجهاز بكل أمان

مقدمة : إن الهدف من هذه التوصيات هو المساهمة خلال عملية الاستعمال، في حماية المكونات بالنسبة لتثبيت سخان ذو الاستعمال المنزلي و توفير الماء الساخن للاستعمال الصحي، مع بيان التصرفات المناسبة و الواجب اتخاذها لتفادي الاخلال بخصائص الأمان الأصلية عن طريق احتمال تركيب خاطئ للجهاز، استعمال غير مناسب أو غير عقلائي. إن الهدف من نشر هذه التوصيات أيضا هو تحسيس جمهور المستعملين بمشاكل الأمان عن طريق لغة ضروري أن تكون تقنية لكن في متناول الجميع. إن المنتج يرفض تحمل أي مسؤولية تعاقدية أو غير متعاقدية في حالة الأضرار التي تتسبب فيها الأخطاء المرتكبة خلال التركيب أو الإستعمال و في كل الحالات بعدم احترام التوصيات المقدمة من طرف المنتج.

توصيات عامة

- ❖ إن دليل المستخدم جزء أساسي لا يتجزأ من المنتج يجب تقديمه إلى المستعمل. اقرأ جيدا التوصيات الواردة في الدليل لاحتوائها على معلومات هامة بخصوص التركيب، الاستعمال و الصيانة الآمنة. احتفظ جيدا بدليل الإستعمال لاحتمال الحاجة إليه لاحقا.
 - ❖ يجب تركيب الجهاز طبقا للمعايير المعمول بها، حسب تعليمات المنتج و من طرف احترافيين مؤهلين مهنيا. نعني بالأشخاص المهنيين، الأشخاص المتمتعين بالكفاءات التقنية اللازمة في ميدان أجزاء السخان ذو الإستعمال الخاص و التزويد بالماء الساخن ذو الإستعمال الصحي و بصفة خاصة مراكز خدمات ما بعد البيع المعتمدة من طرف المنتج. التركيب الغير المناسب قد يتسبب في أضرار للإنسان و الحيوان يتجرّد البائع من تحمل أي مسؤولية.
 - ❖ بعد إزالة كاملة الأغلفة، تأكد من حالة المحتوى، في حالة شك لا تستعمل الجهاز و اتصل بالمومون.
- عناصر التعليل (ققص من خشب، مسامير، مساسيك، بلاستيك، الخ) لا تترك في متناول الأطفال لتشكلها خطر عليهم.
- قبل الشروع في أي عملية تنظيف أو صيانة، اعزل الجهاز عن شبكة التزويد باستعمال القاطع أو أجهزة القطع الملائمة.
 - في حالة عطب أو سوء استعمال الجهاز، اعزله و لا تقع باي محاولة تصليح أو تدخل مباشر. يجب اللجوء فقط لمهنيين مؤهلين. عملية تصليح الأجزاء المحتملة يجب أن تكون في مراكز خدمات ما بعد البيع لشركة سيماكس باستعمال قطع غير أصلية فقط. عدم التقيد بهذا الإجراء قد يخ بأمان الجهاز. لضمان مردود فعال، يستحسن القيام بعمليات صيانة دورية من طرف أشخاص مألين مع احترام تعليمات المنتج.
 - في حالة بيع أو نقل الجهاز، و في حالة رحيل المالك و ترك الجهاز يعمل، يجب التأكد من مرافقة دليل الاستخدام للجهاز حتى يتمكن من تشغيله أو تركيبه.

شروط تطبيق الضمان :

لا يتم تطبيق هذا الضمان إلا في حالة ما إذا تم تقديم المنتج الذي به جلال مدة الضمان مرفقا بفاتورة الشراء. كما تحتفظ شركة سيماكس في حقها في أن ترفض التطبيق المجاني للضمان إذا لم يتم تقديم هذه الوثائق أو إذا كانت غير واضحة أو غير مكتملة. في كل الأحوال فإن الزبون النهائي سوف يتم مطالبته بتقديم الفاتورة المتضمنة لكل المعلومات عن طبيعة المنتج و تاريخ الشراء و غيره من المعلومات المذكورة في القصاصمة المرفقة للفاتورة.

من إنتاج شركة "سيب أونيجاز
إيطاليا

هاتف: +39 049 9200944

فاكس: +39 049 9200945



C.I.B. UNIGAS S.p.A.

Via L.Galvani, 9 - 35011 Campodarsego (PD) - ITALY Tel.
+39 049 9200944 - Fax +39 049 9200945/9201269 web
site: www.cibunigas.it - e-mail: cibunigas@cibunigas.it



USER'S MANUAL

COD. M12925CA Rel 1.2 08/2014

SOFTWARE VERSION 1.0x T73
code 80379 / Edition 01 - 06/2012



1 • INSTALLATION

• Dimensions and cut-out; panel mounting

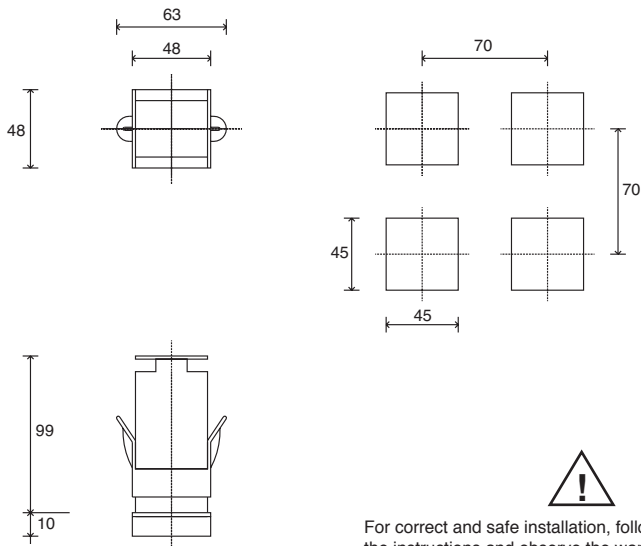

For correct and safe installation, follow the instructions and observe the warnings contained in this manual.

Panel mounting:

To fix the unit, insert the brackets provided into the seats on either side of the case. To mount two or more units side by side, respect the cut-out dimensions shown in the drawing.

CE MARKING: The instrument conforms to the European Directives 2004/108/CE and 2006/95/CE with reference to the generic standards: **EN 61000-6-2** (immunity in industrial environment) **EN 61000-6-3** (emission in residential environment) **EN 61010-1** (safety).

MAINTENANCE: Repairs must be done only by trained and specialized personnel. Cut power to the device before accessing internal parts.

Do not clean the case with hydrocarbon-based solvents (Petrol, Trichlorethylene, etc.). Use of these solvents can reduce the mechanical reliability of the device. Use a cloth dampened in ethyl alcohol or water to clean the external plastic case.

SERVICE: GEFRAN has a service department. The warranty excludes defects caused by any use not conforming to these instructions.

EMC conformity has been tested with the following connections

FUNCTION	CABLE TYPE	LENGTH
Power supply cable	1 mm ²	1 m
Relay output cable	1 mm ²	3,5 m
TC input	0,8 mm ² compensated	5 m
Pt100 input	1 mm ²	3 m

2 • TECHNICAL SPECIFICATIONS

Display	2x4 digit green, high display 10 and 7mm
Keys	4 of mechanical type (Man/Aut, INC, DEC, F)
Accuracy	0.2% f.s. ±1 digit ambient temperature 25°C
Main input (settable digital filter)	TC, RTD, PTC, NTC 60mV, 1V Ri≥1MΩ; 5V, 10V Ri≥10KΩ; 20mA Ri=50Ω Tempo di campionamento 120 msec.
Type TC Thermocouples (ITS90)	Type TC Thermocouples : J,K,R,S,T (IEC 584-1, CEI EN 60584-1, 60584-2) ; custom linearization is available / types B,E,N,L GOST,U,G,D,C are available by using the custom linearization.
Cold junction error	0,1° / °C
RTD type (scale configurable within indicated range, with or without decimal point) (ITS90) Max line resistance for RTD	DIN 43760 (Pt100), JPT100 20Ω
PTC type / NTC Type	990Ω, 25°C / 1KΩ, 25°C
Safety	detection of short-circuit or opening of probes, LBA alarm
°C / °F selection	configurable from faceplate
Linear scale ranges	-1999 to 9999 with configurable decimal point position
Controls	PID, Self-tuning, on-off
pb - dt - it	0,0...999,9 % - 0,00...99,99 min - 0,00...99,99 min
Action	Heat / Cool
Control outputs	on / off
Maximum power limit heat / cool	0,0...100,0 %
Cycle time	0...200 sec
Main output type	relay, logic, continuous (0...10V Rload ≥ 250KΩ, 0/4...20mA Rload ≤ 500Ω)
Softstart	0,0...500,0 min
Fault power setting	-100,0...100,0 %
Automatic blanking	Displays PV value, optional exclusion
Configurable alarms	Up to 3 alarm functions assignable to an output, configurable as: maximum, minimum, symmetrical, absolute/deviation, LBA
Alarm masking	- exclusion during warm up - latching reset from faceplate or external contact
Type of relay contact	NO (NC), 5A, 250V/30Vdc cosφ=1
Logic output for static relays	24V ±10% (10V min at 20mA)
Transmitter power supply	15/24Vdc, max 30mA short-circuit protection
Power supply (switching type)	(std) 100 ... 240Vac ±10% (opt.) 11...27Vac/dc ±10%; 50/60Hz, 8VA max
Faceplate protection	IP65
Working / Storage temperature range	0...50°C / -20...70°C
Relative humidity	20 ... 85% non-condensing
Environmental conditions of use	for internal use only, altitude up to 2000m
Installation	Panel, plug-in from front
Weight	160g for the complete version

3 · DESCRIPTION OF FACEPLATE

Function indicators
Indicates modes of operation

L1 MAN/AUTO = OFF (automatic control)
ON (manual control)

L2 PRE-HEATING = ON (running)

L3 SELFTUNING = ON (enabled Self)
OFF (disabled Self)

Automatic/Manual adjustment selection
Active only when PV display visualises the process variable (button pressed for at least 5 sec.)

"Inc" and "Dec" key
Press to increment (decrement) any numerical parameter •• Increment (decrement) speed is proportional to time key stays pressed •• The operation is not cyclic: once the maximum (minimum) value of a field is reached, the value will not change even if the key remains pressed.

Indication of output states
OUT 1 (AL1); OUT 2 (OPEN); OUT 3 (CLOSED)

PV Display: Indication of process variable
Error Indication: LO, HI, Sbr, Err
LO= the value of process variable is < di LO_S
HI= the value of process variable is > di HI_S
Sbr= faulty sensor or input values higher than max. limits
Err= PT100 third wire opened for PT100, PTC or input values lower than min. limits (i.e.: TC wrong connection)

SV display: Indication of setpoint

Function key
Gives access to the various configuration phases •• Confirms change of set parameters and browses next or previous parameter (if Auto/Man key is pressed)

4 · CONNECTIONS

• Outputs

Out2 (19) - 5A at 250Vac/30Vdc relay

Out1 (20) - 5A/250Vac relay

Out3 (6) - 5A at 250Vac/30Vdc relay

TOP

• Inputs

• TC Input

Available thermocouples:
J, K, R, S, T
(B, E, N, L, U, G, D, C custom linearization is available)

- Observe polarities
- For extensions, use the correct compensating cable for the type of TC used

• Power Supply

Standard:
100...240Vac ± 10%

Optional:
11...27Vac/Vdc ± 10%

Max. power 8VA; 50/60 Hz

• Linear input (I)

Linear input in dc current

20mA, Ri = 50Ω

• Input 1 linear with transmitter 2 wires

• Identification of boards

Power board - Solder side

Select transmitter voltage

N.B. : you can keep the **OUT1** relay energized at power-up by inserting jumper **S2** and removing resistance **R20**.

CPU board - Component side

IN/OUT boards (see appendix)

Select signal at contact 3

• Linear input (V)

Linear input in dc voltage
60mV, 1V
Ri > 1MΩ
5V, 10V
Ri > 10KΩ

• Pt100 / PTC / NTC

Use wires of adequate diameter (min. 1mm²)
PT100, JPT100, PTC, NTC

• Device structure

5 • “EASY” PROGRAMMING and CONFIGURATION

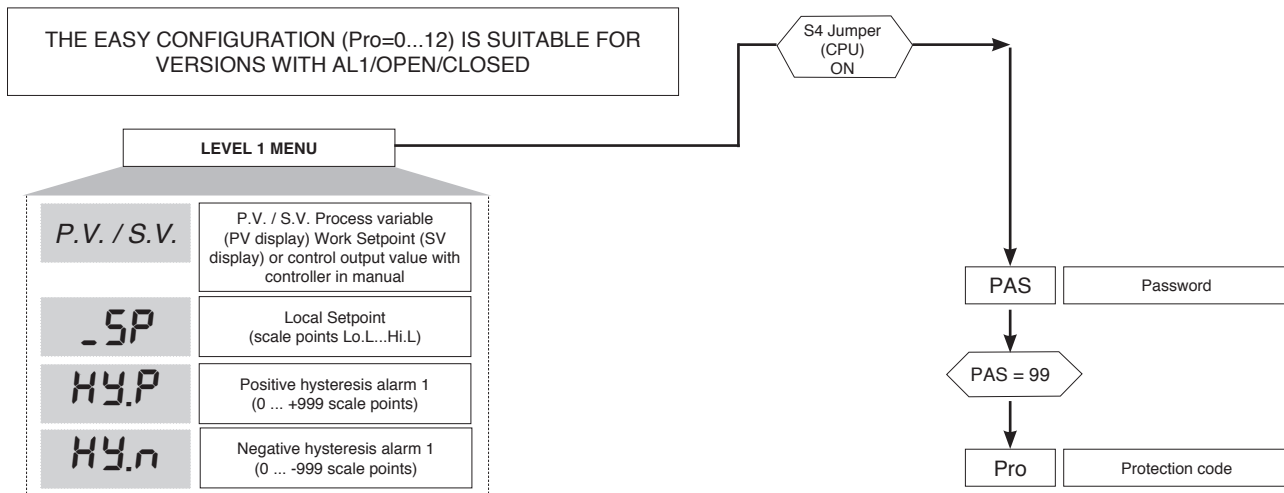

• Prot

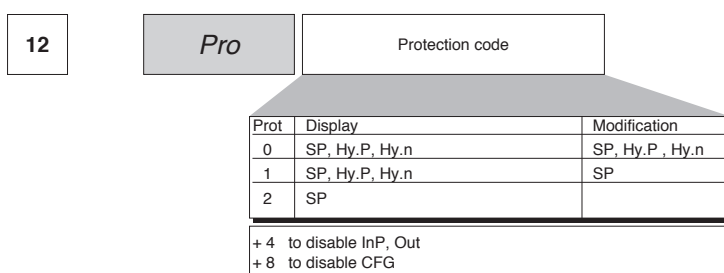

6 • PROGRAMMING and CONFIGURATION

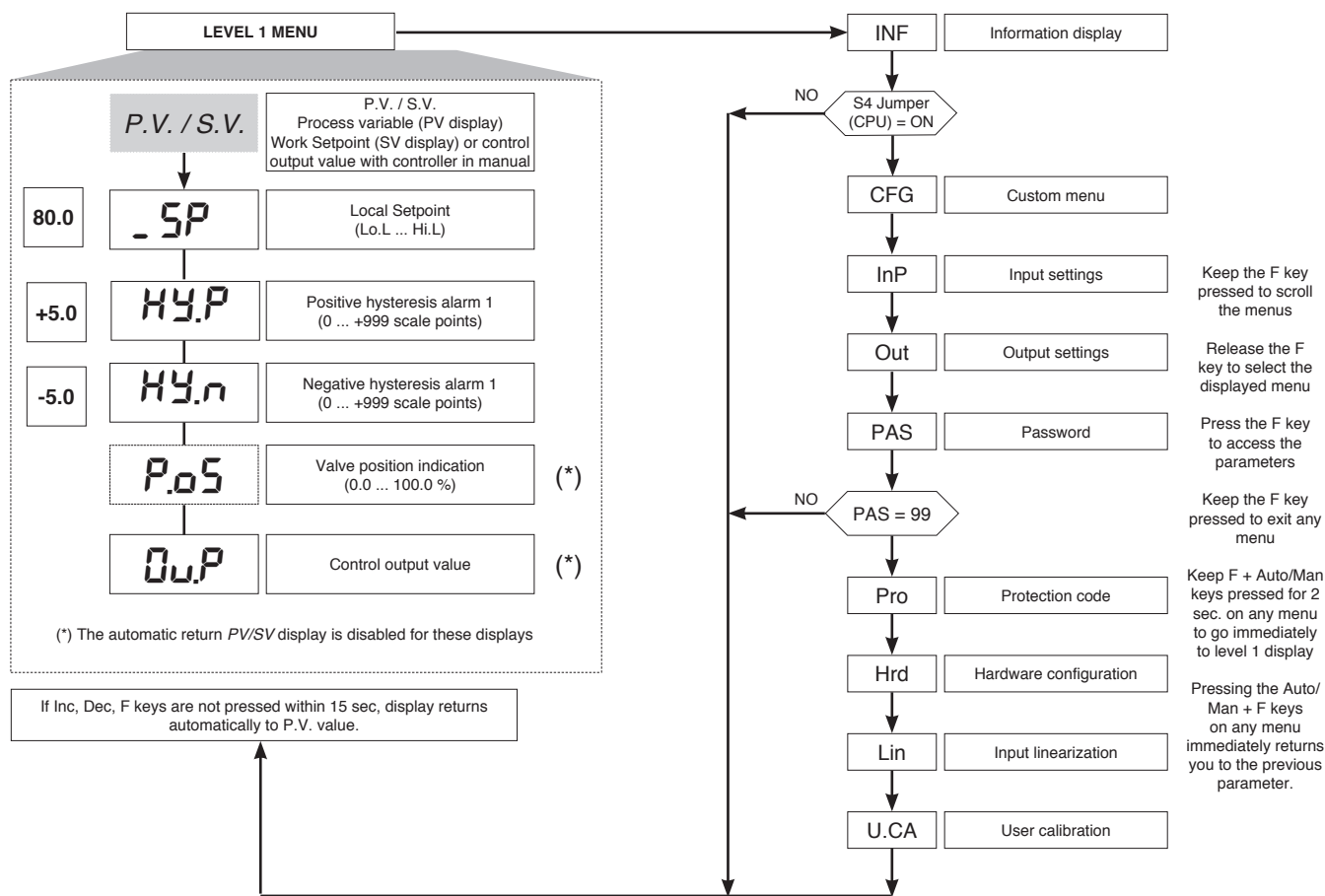

N.B.: Once a particular configuration is entered, all unnecessary parameters are no longer displayed

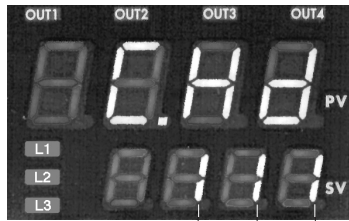

OUTPUT 2	OUTPUT 3	SERIAL COMMUNICATION
0 = None	0 = None	0 = None
1 = Relay	1 = Relay	

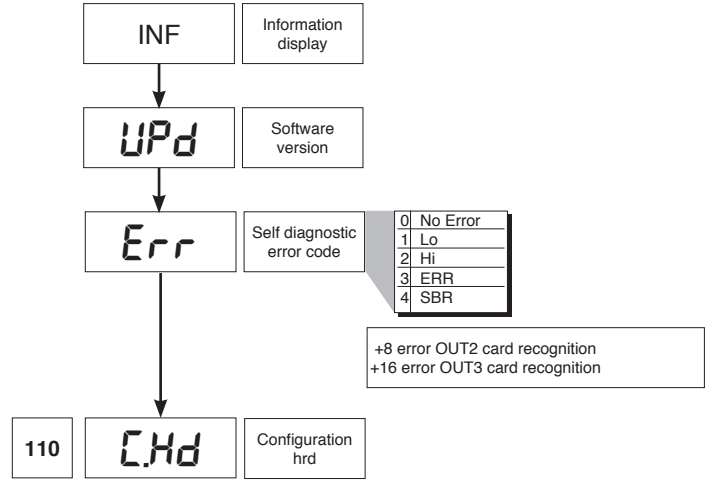

• CFG

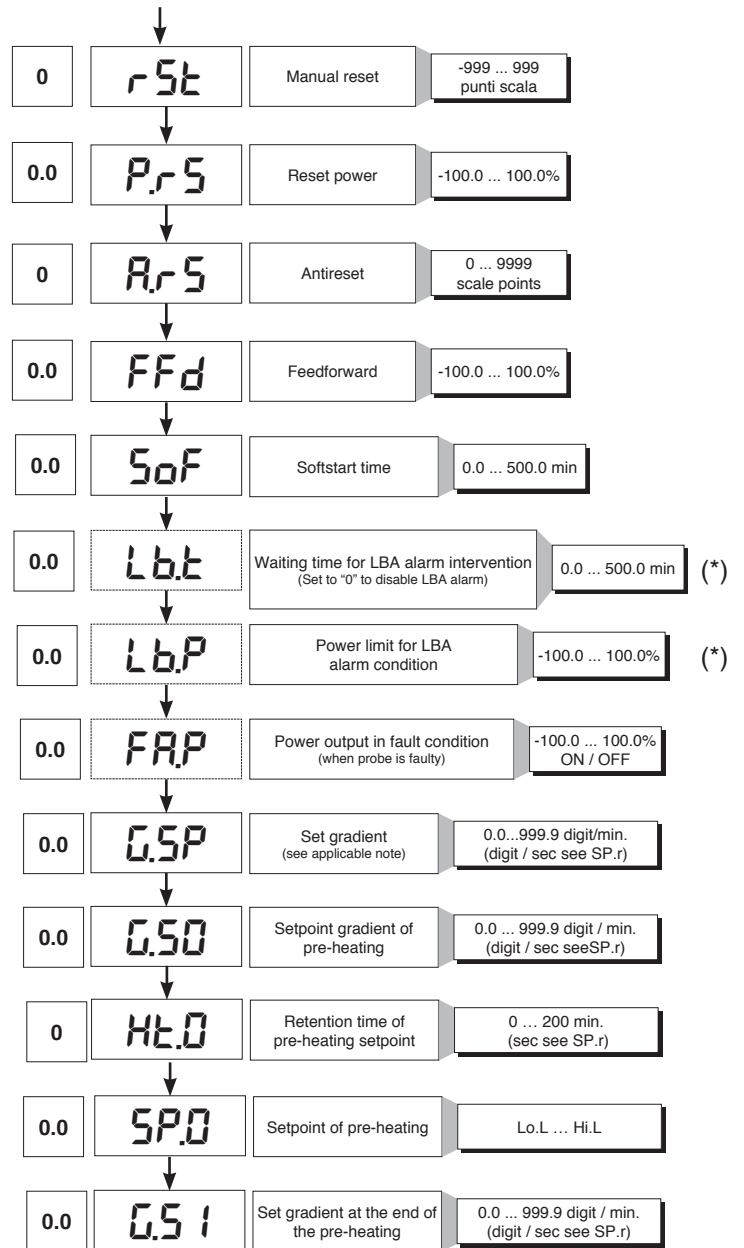
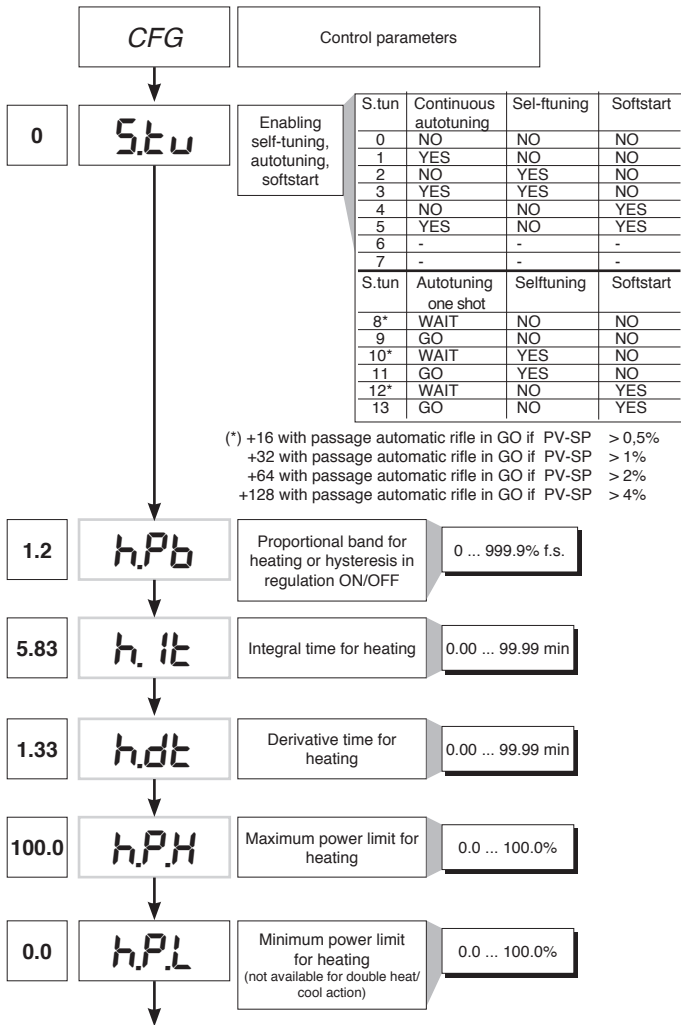

(*) LBA alarm may be reset by simultaneously pressing Δ + ▽ keys when OutP is displayed or by switching to Manual.

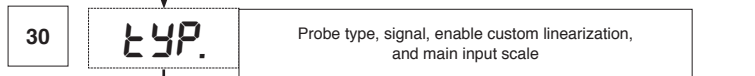
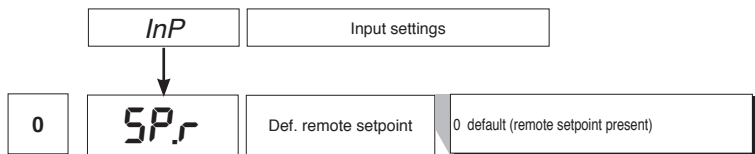

Type	Probe type	without decimal point	with decimal point
Sensore:			
TC			
0	TC J °C	0/1000	0.0/999.9
1	TC J °F	32/1832	32.0/999.9
2	TC K °C	0/1300	0.0/999.9
3	TC K °F	32/2372	32.0/999.9
4	TC R °C	0/1750	0.0/999.9
5	TC R °F	32/3182	32.0/999.9
6	TC S °C	0/1750	0.0/999.9
7	TC S °F	32/3182	32.0/999.9
8	TC T °C	-200/400	-199.9/400.0
9	TC T °F	-328/752	-199.9/752.0
28	TC	CUSTOM	CUSTOM
29	TC	CUSTOM	CUSTOM
30	PT100 °C	-200/850	-199.9/850.0
31	PT100 °F	-328/156.2	-199.9/999.9
32	JPT100 °C	-200/600	-199.9/600.0
33	JPT100 °F	-328/1112	-199.9/999.9
34	PTC °C	-55/120	-55.0/120.0
35	PTC °F	-67/248	-67.0/248.0
36	NTC °C	-10/70	-10.0/70.0
37	NTC °F	14/158	14.0/158.0
38	0...60 mV	-1999/9999	-199.9/999.9
39	0...60 mV	Custom scale	Custom scale
40	12...60 mV	-1999/9999	-199.9/999.9
41	12...60 mV	Custom scale	Custom scale
42	0...20 mA	-1999/9999	-199.9/999.9
43	0...20 mA	Custom scale	Custom scale
44	4...20 mA	-1999/9999	-199.9/999.9
45	4...20 mA	Custom scale	Custom scale
46	0...10 V	-1999/9999	-199.9/999.9
47	0...10 V	Custom scale	Custom scale
48	2...10 V	-1999/9999	-199.9/999.9
49	2...10 V	Custom scale	Custom scale
50	0...5 V	-1999/9999	-199.9/999.9
51	0...5 V	Custom scale	Custom scale
52	1...5 V	-1999/9999	-199.9/999.9
53	1...5 V	Custom scale	Custom scale
54	0...1 V	-1999/9999	-199.9/999.9
55	0...1 V	Custom scale	Custom scale
56	200mv...1V	-1999/9999	-199.9/999.9
57	200mv...1V	Custom scale	Custom scale
58	Cust10 V-20mA	-1999/9999	-199.9/999.9
59	Cust10 V-20mA	Custom scale	Custom scale
60	Cust 60mV	-1999/9999	-199.9/999.9
61	Cust 60mV	Custom scale	Custom scale
62	PT100-JPT	CUSTOM	CUSTOM
63	PTC	CUSTOM	CUSTOM
64	NTC	CUSTOM	CUSTOM

For custom linearization:
 - LO signal is generated with variable below Lo.S or at minimum calibration value
 - HI signal is generated with variable above Lo.S or at maximum calibration value

Max. non-linearity error for thermocouples (TC), resistors (PT100) and thermistors (PTC, NTC).
 The error is calculated as deviation from theoretical value and is expressed as percentage of full scale (in °C).

S, R range 0...1750°C; error < 0.2% f.s. (t > 300°C) / for other range; error < 0.5% f.s.
T error < 0.2% f.s. (t > -150°C)
B range 44...1800°C; error < 0.5% f.s. (t > 300°C) / range 44.0...999.9; error < 1% f.s. (t > 300°C)
U range -99.9...99.9 and -99...99°C; error < 0.5% f.s. / for other range; error < 0.2% f.s. (t > -150°C)
G error < 0.2% f.s. (t > 300°C)
D error < 0.2% f.s. (t > 200°C)
C range 0...2300; error < 0.2% f.s. / for other range; error < 0.5% f.s.

NTC error < 0.5% f.s.

Tc: J, K, E, N, L error < 0,2% f.s.
 JPT100 and PTC error < 0,2% f.s.
 PT100 scale -200...850°C
 Precision better than 0,2% f.s. at 25°C
 In range 0...50°C:
 • Precision better than 0,2% f.s. in range -200...400°C
 • Precision better than 0,4% f.s. in range +400...850°C (where f.s. refers to range -200... +850°C)

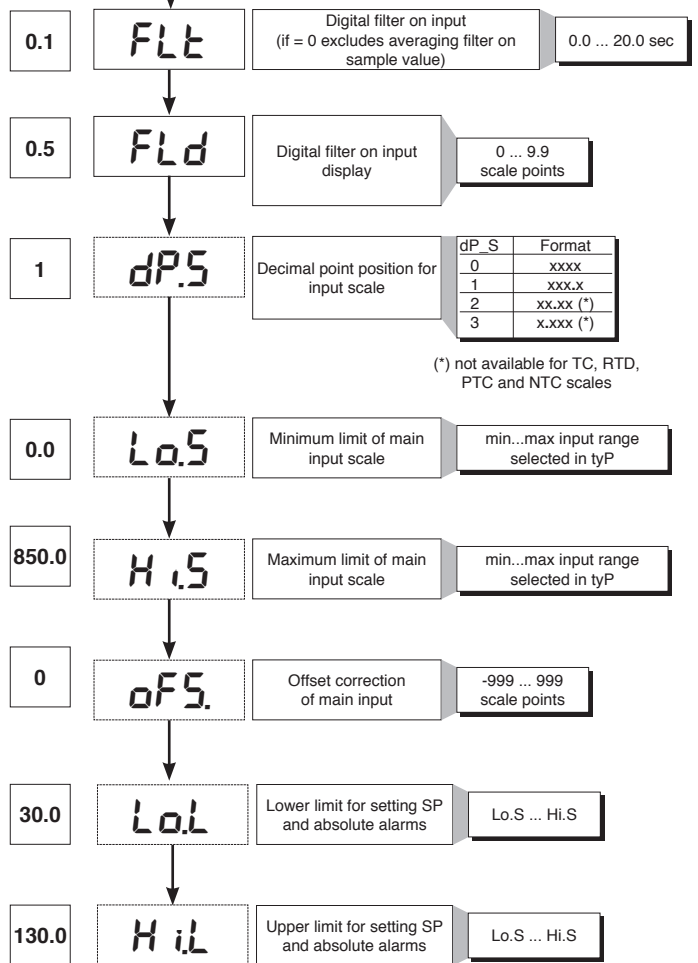

(*) not available for TC, RTD, PTC and NTC scales

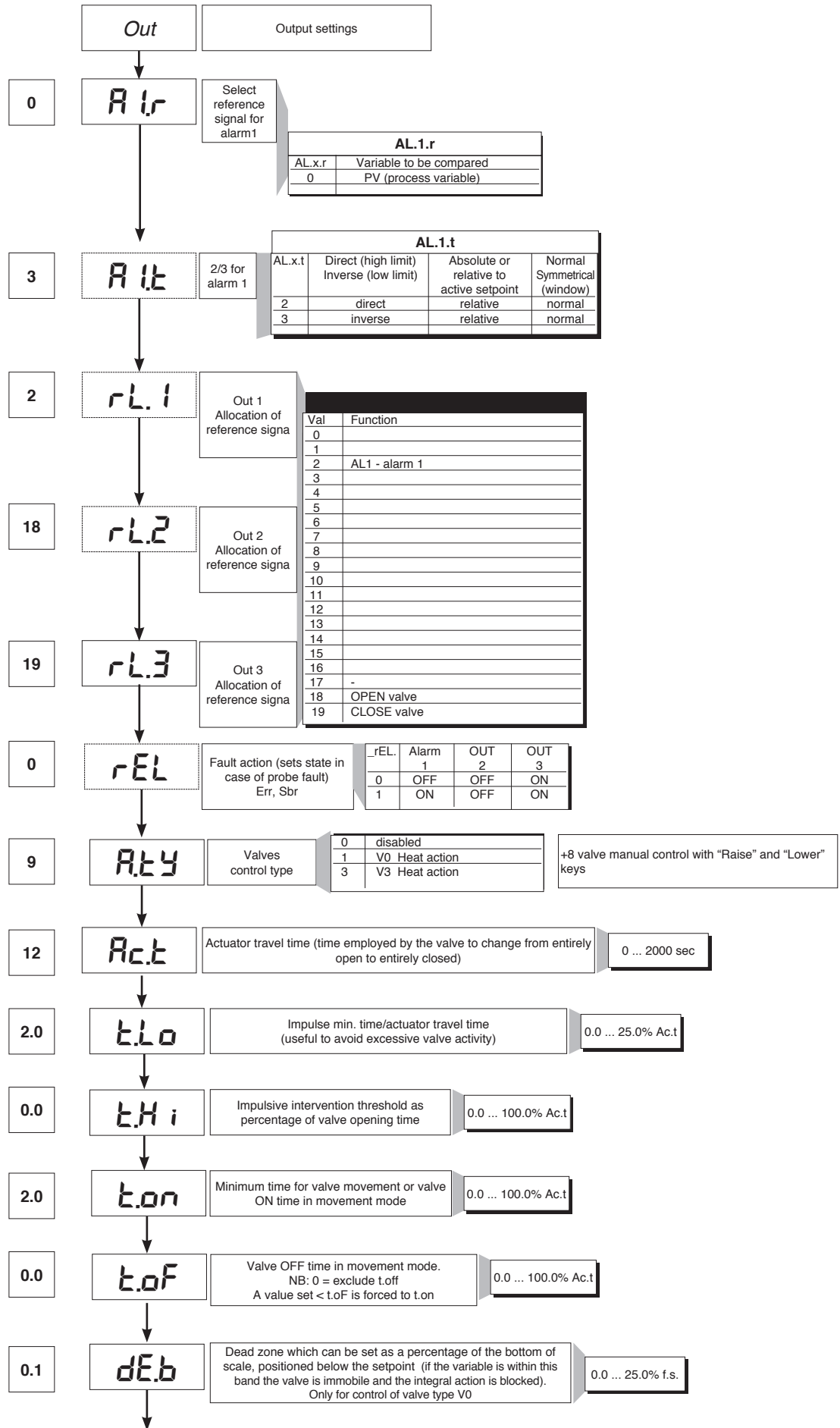

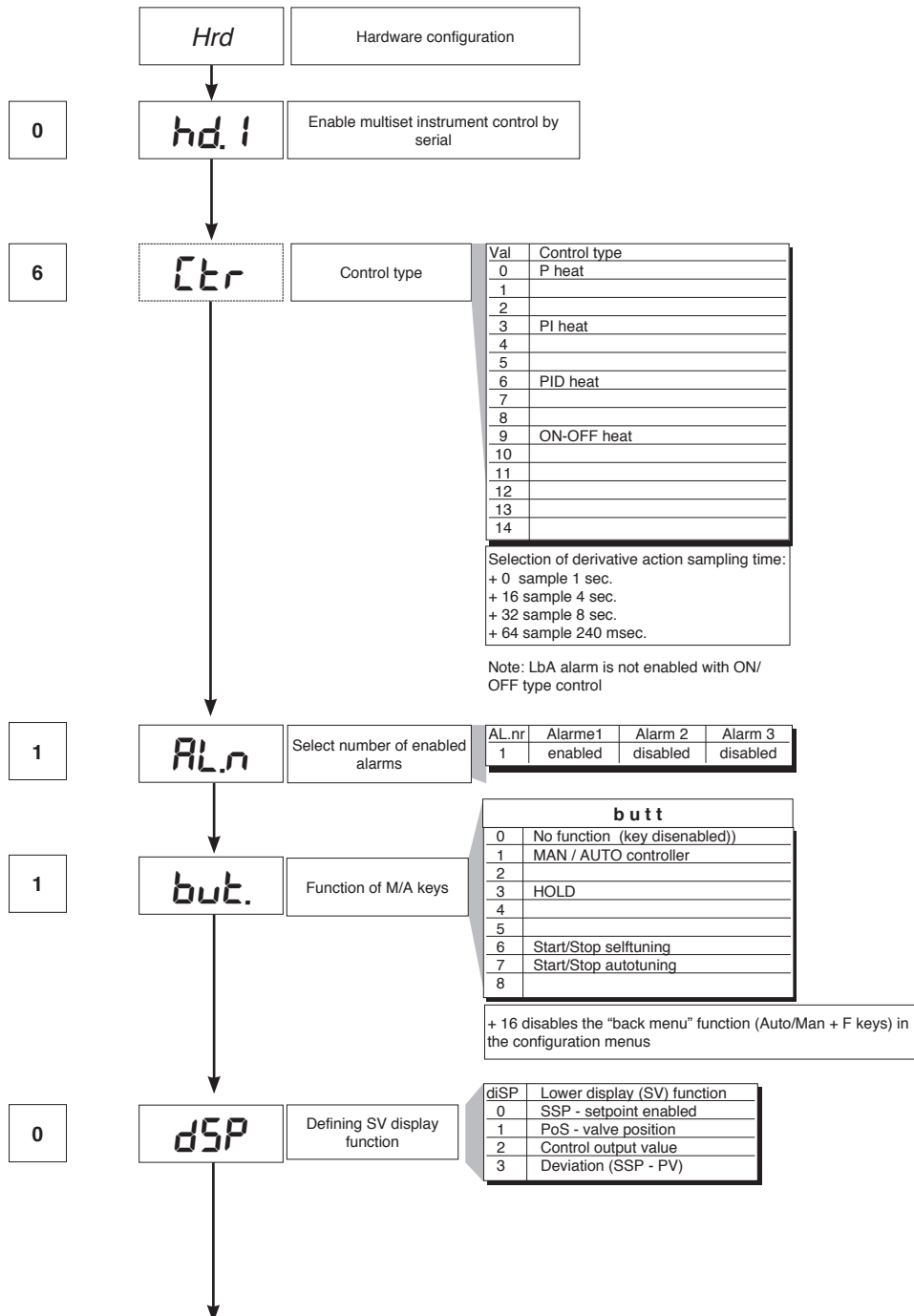
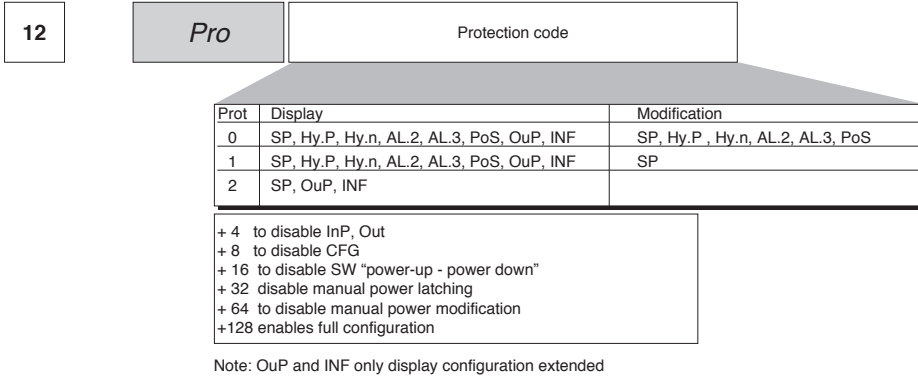

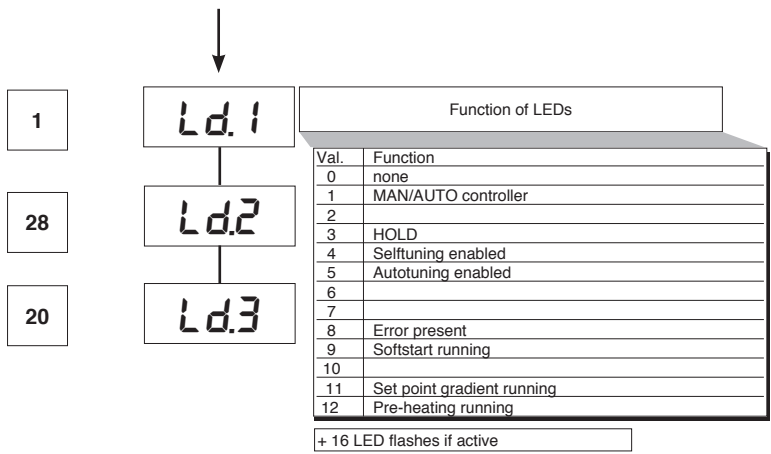

• Lin

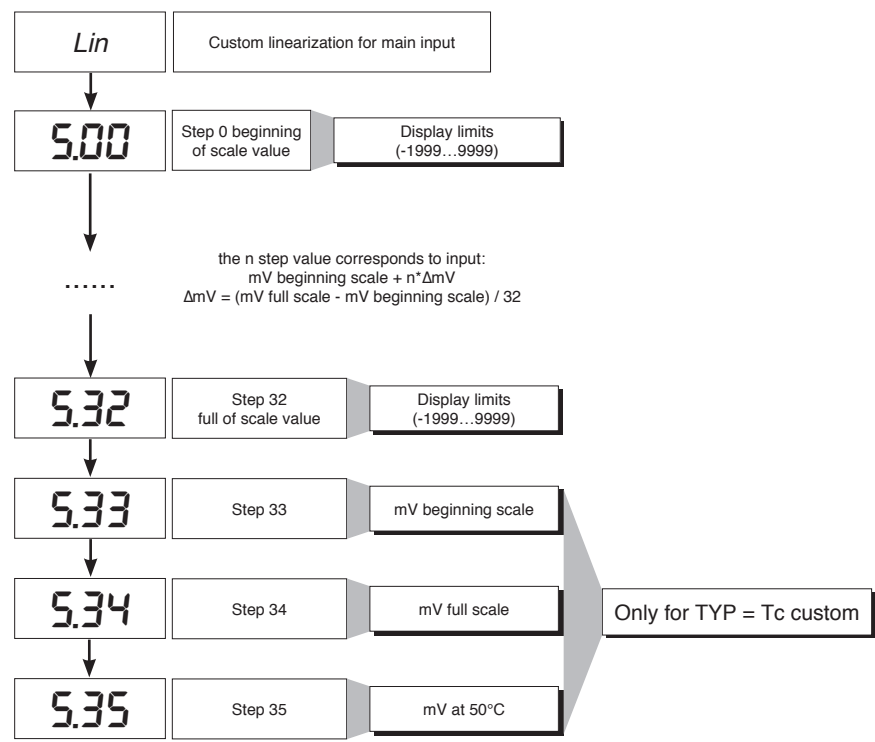

• U.CAL

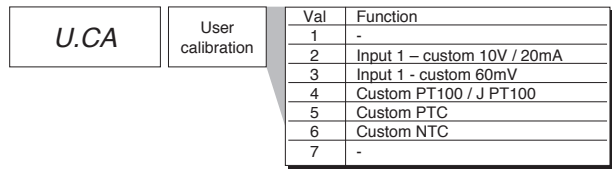

7 · CONSENT FOR BURNER AL1

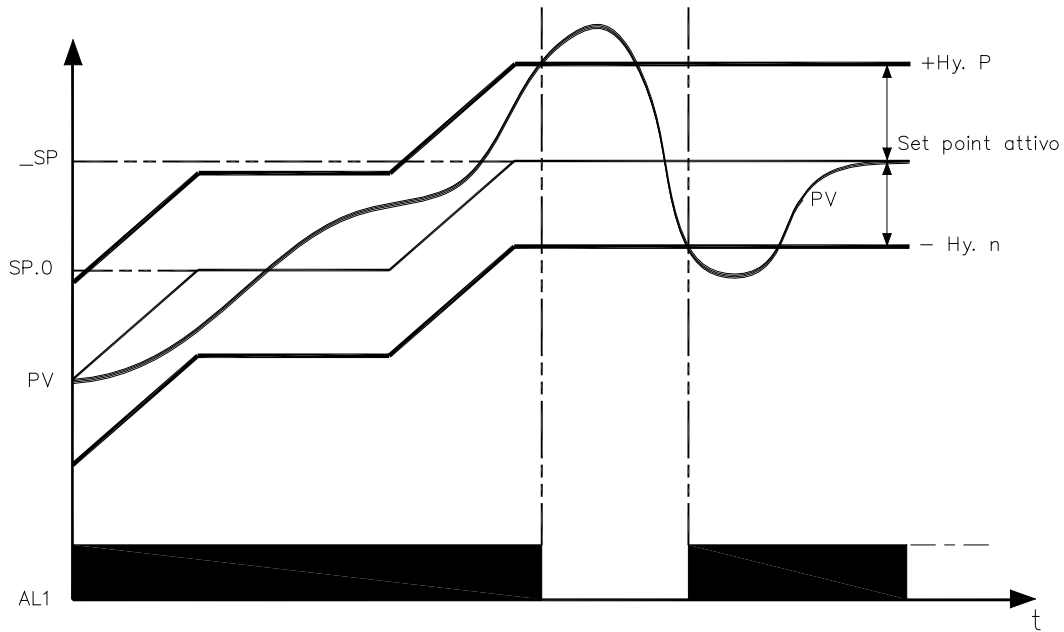

Obtain burner consent by configuring alarm 1 as inverse deviation with positive hysteresis Hy.P and negative hysteresis Hy.n

8 · PRE-HEATING FUNCTION

Enable the pre-heating function by setting parameters GS.0, Ht.0, GS.1 other than zero. It consists of three phases that are activated sequentially at firing:

- Ramp 0 phase

Enabled by setting $GS.0 > 0$. Starting from setpoint = PV (initial state), it reaches pre-heating set SP.0 with gradient GS.0

- Maintenance phase

Enabled by setting $Ht.0 > 0$. Maintains pre-heating setpoint SP.0 for time Ht.0

- Ramp 1 phase

Enabled by setting $GS.1 > 0$. Starting from pre-heating setpoint SP.0, it reaches active $_SP$ set with gradient GS.1

In case of selftuning, the pre-heating function is not activated

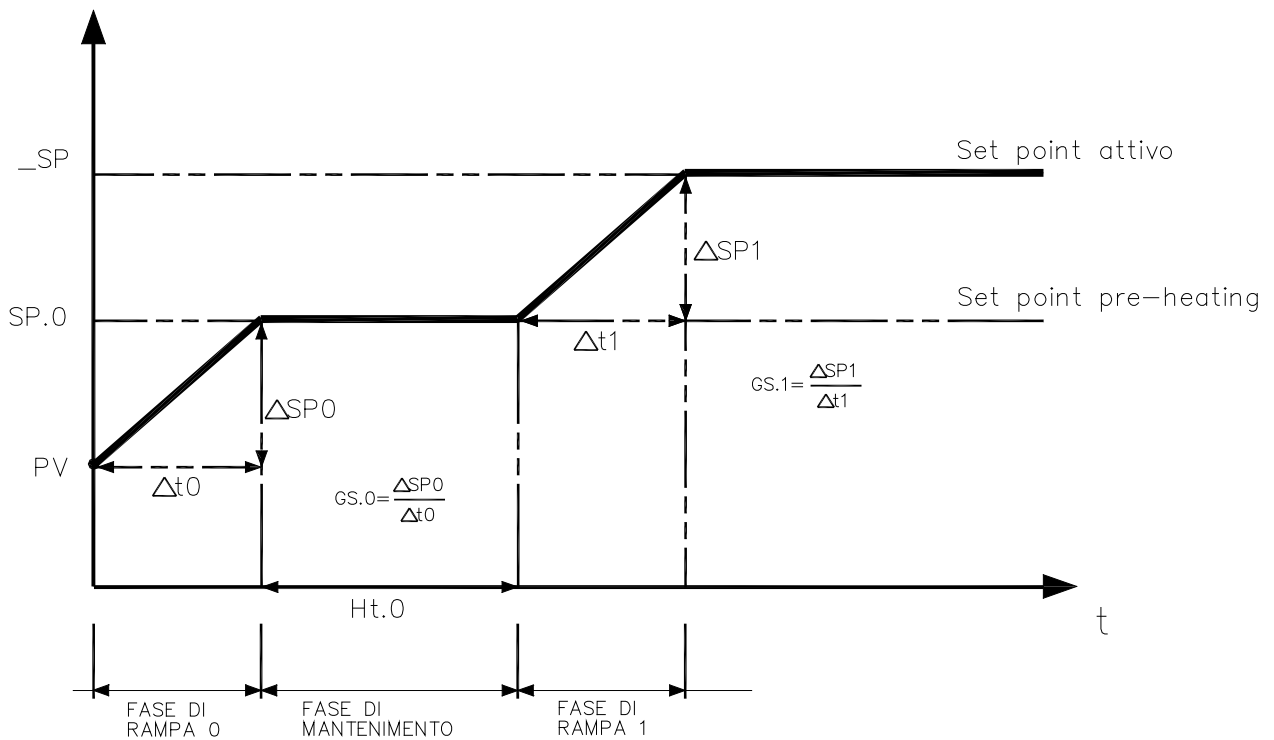

9 • ADJUSTMENT WITH MOTORIZED VALVE

In an adjustment process the adjustment valve has the function of varying fuel delivery (frequently corresponding to the thermal energy introduced into the process) in relation to the signal coming from the controller.

For this purpose it is provided with an actuator able to modify its opening value, overcoming the resistances produced by the fluid passing inside it.

The adjustment valves vary the delivery in a modulated manner, producing finite variations in the fluid passage inner area corresponding to finite variations of the actuator input signal, coming from the controller. The servomechanism, for example, comprises an electric motor, a reducer and a mechanical transmission system which actions the valve.

Various auxiliary components can be present such as the mechanical and electrical safety end travels, manual actioning systems.

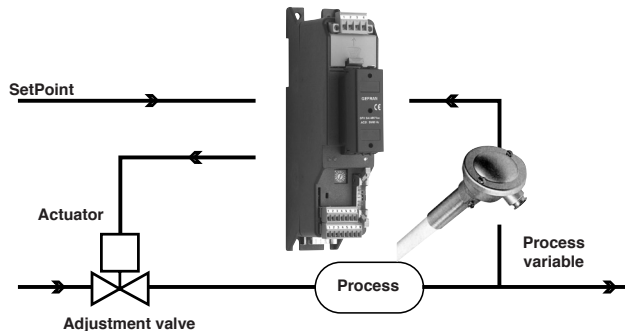

CONTROL EXAMPLE FOR V0 VALVE

The controller determines, on the basis of the dynamics of the process, the control output for the valve corresponding to the opening of the same in such a way so as to maintain the desired value of the process variable.

Characteristic parameters for valves control

- Actuator time ($A_c.t$) is the time employed by the valve to pass from entirely open to entirely closed (or vice-versa), and can be set with a resolution of one second. It is a mechanical feature of the valve+actuator unit.

NOTE: if the actuator's travel is mechanically limited it is necessary to proportionally reduce the $A_c.t$ value.

- Minimum impulse ($t.Lo$) expressed as a % of the actuator time (resolution 0.1%).

Represents the minimum change in position corresponding to a minimum change in power supplied by the instrument below which the actuator will not physically respond to the command.

This represents the minimum variation in position due to which the actuator does not physically respond to the command.

The minimum duration of the movement can be set in $t.Lo$, expressed as a % of actuator time.

- Impulsive intervention threshold ($t.Hi$) expressed as a % of the actuator time (resolution 0.1%) represents the position displacement (requested position – real position) due to which the manoeuvre request becomes impulsive.

You can choose between 2 types of control:

1) ON time of movement = $t.on$ and OFF time proportional to shift and greater than or equal to $t.Lo$ (we recommend setting $t.on = t.Lo$) (set $t.oF = 0$).

2) ON time of movement = $t.on$ and OFF time = $t.oF$. A value set for $t.oF < t.on$ is forced to $t.on$. To activate this type, set $t.oF >> 0$.

The type of movement approach allows fine control of the reverse drive valve (from potentiometer or not), especially useful in cases of high mechanical inertia. Set $t.Hi = 0$ to exclude modulation in positioning.

This type of modulated approach allows precise control of the feedback actioned valve, by a potentiometer or not, and is especially useful in cases of high mechanical inertia. Setting $t.Hi = 0$ excludes modulation in positioning.

- Dead zone ($dE.b$) is a displacement band between the adjustment setpoint and the process variable within which the controller does not supply any command to the valve (Open = OFF; Close = OFF). It is expressed as a percentage of the bottom scale and is positioned below the setpoint.

The dead zone is useful in an operative process to avoid straining the actuator with repeated commands and an insignificant effect on the adjustment. Setting $dE.b = 0$ the dead zone is excluded.

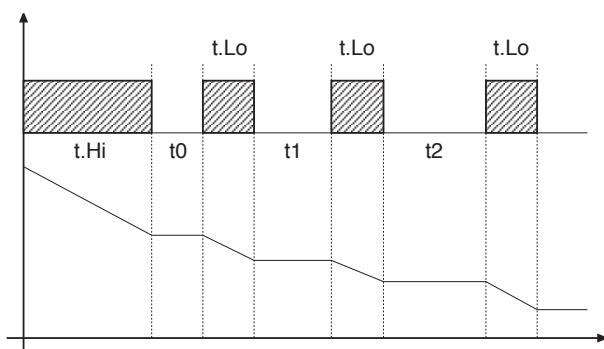

Graph of behavior inside the band with integral time $\neq 0$.

With integral time = 0, movement ON time is always equal to OFF time.

$t_0 = t.Lo$

Valve control modes

With the controller in manual, the setting of parameter At.y ≥ 8 allows direct control of the valve open and close commands through the keyboard Increments and Decrements on the front seats.

V0 - for floating valve without potentiometer

Model V0 have similar behaviour: every manoeuvre request greater than the minimum impulse t.Lo is sent to the actuator by means of the OPEN/CLOSE relays; every action updates the presumed position of the virtual potentiometer calculated on the basis of the actuator travel declared time.

In this way there is always a presumed position of the valve which is compared with the position request of the controller.

Having reached a presumed extreme position (entirely open or entirely closed determined by the "virtual potentiometer") the controller provides a command in the same direction, in this way ensuring the real extreme position is reached (minimum command time = t.on).

The actuators are usually protected against the OPEN command in the entirely open position or CLOSE command in the entirely closed position.

V3 - for floating valve, PI control

When the difference between the position calculated by the controller and the only proportional component exceeds the value corresponding to the minimum impulse t.Lo the controller provides an OPEN or CLOSE command of the duration of the minimum impulse itself t.Lo.

At each delivery the integral component of the command is set to zero (discharge of the integral).

The frequency and duration of the impulses is correlated to the integral time (h.it or c.it).

Non-movement behavior

t.Hi = 0: with power = 100% or 0.0%, the corresponding open or close outputs always remain enabled (safety status).

Movement behavior

t.Hi \neq 0: with position attained corresponding to 100% or 0.0%, the corresponding open or close outputs are switched off.

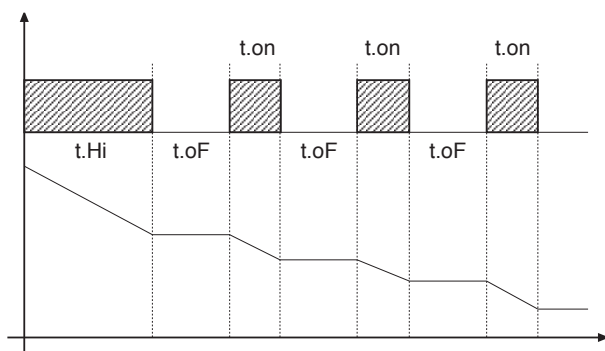

If t.oF = 0, current function is maintained.

If t.oF \neq 0 movement mode will be as shown on the graph

10 • CONTROL ACTIONS

Proportional Action:

action in which contribution to output is proportional to deviation at input (deviation = difference between controlled variable and setpoint).

Derivative Action:

action in which contribution to output is proportional to rate of variation input deviation.

Integral Action:

action in which contribution to output is proportional to integral of time of input deviation.

Influence of Proportional, Derivative and Integral actions on response of process under control

- * An increase in P.B. reduces oscillations but increases deviation.
- * A reduction in P.B. reduces the deviation but provokes oscillations of the controlled variable (the system tends to be unstable if P.B. value is too low).
- * An increase in Derivative Action corresponds to an increase in Derivative Time, reduces deviation and prevents oscillation up to a critical value of Derivative Time, beyond which deviation increases and prolonged oscillations occur.
- * An increase in Integral Action corresponds to a reduction in Integral Time, and tends to eliminate deviation between the controlled variable and the setpoint when the system is running at rated speed.

If the Integral Time value is too long (Weak integral action), deviation between the controlled variable and the setpoint may persist.

Contact GEFRA for more information on control actions.

11 • MANUAL TUNING

- A) Enter the setpoint at its working value.
- B) Set the proportional band at 0.1% (with on-off type setting).
- C) Switch to automatic and observe the behavior of the variable. It will be similar to that in the figure:

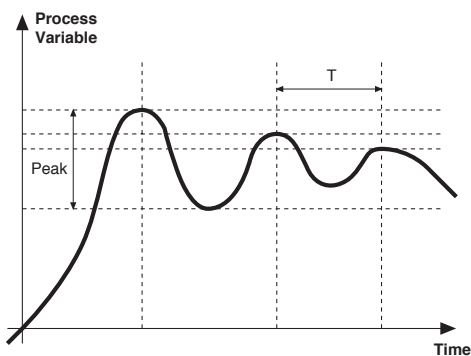

D) The PID parameters are calculated as follows: Proportional band

$$P.B. = \frac{\text{Peak}}{(V \text{ max} - V \text{ min})} \times 100$$

(V max - V min) is the scale range.

Integral time: $I_t = 1.5 \times T$

Derivative time: $d_t = I_t/4$

E) Switch the unit to manual, set the calculated parameters. Return to PID action by setting the appropriate relay output cycle time, and switch back to Automatic.

F) If possible, to optimize parameters, change the setpoint and check temporary response. If an oscillation persists, increase the proportional band. If the response is too slow, reduce it.

12 • SET GRADIENT

SET GRADIENT: if set to $\neq 0$, the setpoint is assumed equal to PV at power-on and auto/man switchover. With gradient set, it reaches the local setpoint. Every variation in setpoint is subject to a gradient.

The set gradient is inhibited at power-on when self-tuning is engaged.

If the set gradient is set to $\neq 0$, it is active even with variations of the local setpoint.

The control setpoint reaches the set value at the speed defined by the gradient.

13 • SOFTWARE ON / OFF SWITCHING FUNCTION

How to switch the unit OFF: hold down the "F" and "Raise" keys simultaneously for 5 seconds to deactivate the unit, which will go to the OFF state while keeping the line supply connected and keeping the process value displayed. The SV display is OFF.

All outputs (alarms and controls) are OFF (logic level 0, relays de-energized) and all unit functions are disabled except the switch-on function and digital communication.

How to switch the unit ON: hold down the "F" key for 5 seconds and the unit will switch OFF to ON. If there is a power failure during the OFF state, the unit will remain in OFF state at the next power-up (ON/OFF state is memorized).

The function is normally enabled, but can be disabled by setting the parameter Prot = Prot +16.

14 • SELF-TUNING

The function works for single output systems (heating or cooling). The self-tuning action calculates optimum control parameter values during process startup. The variable (for example, temperature) must be that assumed at zero power (room temperature).

The controller supplies maximum power until an intermediate value between starting value and setpoint is reached, after which it zeros power.

PID parameters are calculated by measuring overshoot and the time needed to reach peak. When calculations are finished, the system disables automatically and the control proceeds until the setpoint is reached.

How to activate self-tuning:

A. Activation at power-on

1. Set the setpoint to the required value
2. Enable selftuning by setting the Stun parameter to 2 (CFG menu)
3. Turn off the instrument
4. Make sure the temperature is near room temperature
5. Turn on the instrument again

B. Activation from keyboard

1. Make sure that key M/A is enabled for Start/Stop selftuning (code but = 6 Hrd menu)
2. Bring the temperature near room temperature
3. Set the setpoint to the required value
4. Press key M/A to activate selftuning (Attention: selftuning interrupts if the key is pressed again)

The procedure runs automatically until finished, when the new PID parameters are stored: proportional band, integral and derivative times calculated for the active action (heating or cooling). In case of double action (heating or cooling), parameters for the opposite action are calculated by maintaining the initial ratio between parameters (ex.: $CPb = HPb \times K$; where $K = CPb / HPb$ when self-tuning starts). When finished, the Stun code is automatically cancelled.

Notes :

-The procedure does not start if the temperature is higher than the setpoint (heating control mode) or if the temperature is lower than the setpoint (cooling control mode). In this case, the Stun code is not cancelled.

-It is advisable to enable one of the configurable LEDs to signal selftuning status. By setting one of parameters LED1, LED2, LED3=4 or 20 on the Hrd menu, the respective LED will be on or flashing when selftuning is active.

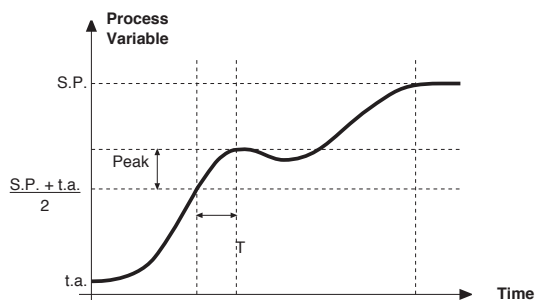

15 • ACCESSORIES

• Interface for instrument configuration



Kit for PC via the USB port (Windows environment) for GEFTRAN instruments configuration:

Lets you read or write all of the parameters

- A single software for all models
- Easy and rapid configuration
- Saving and management of parameter recipes
- On-line trend and saving of historical data

Component Kit:

- Connection cable PC USB ... port TTL
- Connection cable PC USB ... RS485 port
- Serial line converter
- CD SW GF Express installation

• ORDERING CODE

GF_eXK-2-0-0	cod F049095
--------------	-------------

16 • ORDER CODE

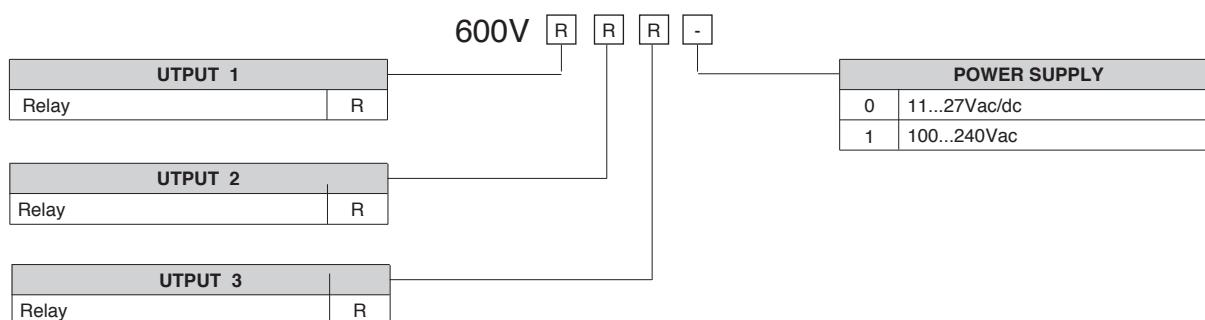

• WARNINGS

WARNING: this symbol indicates danger. It is placed near the power supply circuit and near high-voltage relay contacts.

Read the following warnings before installing, connecting or using the device:

- follow instructions precisely when connecting the device.
- always use cables that are suitable for the voltage and current levels indicated in the technical specifications.
- the device has no ON/OFF switch: it switches on immediately when power is turned on. For safety reasons, devices permanently connected to the power supply require a two-phase disconnecting switch with proper marking. Such switch must be located near the device and must be easily reachable by the user. A single switch can control several units.
- if the device is connected to electrically NON-ISOLATED equipment (e.g. thermocouples), a grounding wire must be applied to assure that this connection is not made directly through the machine structure.
- if the device is used in applications where there is risk of injury to persons and/or damage to machines or materials, it **MUST** be used with auxiliary alarm units. You should be able to check the correct operation of such units during normal operation of the device.
- before using the device, the user must check that all device parameters are correctly set in order to avoid injury to persons and/or damage to property.
- the device must **NOT** be used in inflammable or explosive environments. It may be connected to units operating in such environments only by means of suitable interfaces in conformity to local safety regulations.
- the device contains components that are sensitive to static electrical discharges. Therefore, take appropriate precautions when handling electronic circuit boards in order to prevent permanent damage to these components.

Installation: installation category II, pollution level 2, double isolation

The equipment is intended for permanent indoor installations within their own enclosure or panel mounted enclosing the rear housing and exposed terminals on the back.

- only for low power supply: supply from Class 2 or low voltage limited energy source
- power supply lines must be separated from device input and output lines; always check that the supply voltage matches the voltage indicated on the device label.
- install the instrumentation separately from the relays and power switching devices
- do not install high-power remote switches, contactors, relays, thyristor power units (particularly if "phase angle" type), motors, etc... in the same cabinet.
- avoid dust, humidity, corrosive gases and heat sources.
- do not close the ventilation holes; working temperature must be in the range of 0...50°C.

- surrounding air: 50°C
- use 60/75°C copper (Cu) conductor only, wire size range 2x No 22 - 14AWG, Solid/Stranded
- use terminal tightening torque 0.5N m

If the device has faston terminals, they must be protected and isolated; if the device has screw terminals, wires should be attached at least in pairs.

• **Power:** supplied from a disconnecting switch with fuse for the device section; path of wires from switch to devices should be as straight as possible; the same supply should not be used to power relays, contactors, solenoid valves, etc.; if the voltage waveform is strongly distorted by thyristor switching units or by electric motors, it is recommended that an isolation transformer be used only for the devices, connecting the screen to ground; it is important for the electrical system to have a good ground connection; voltage between neutral and ground must not exceed 1V and resistance must be less than 60hm; if the supply voltage is highly variable, use a voltage stabilizer for the device; use line filters in the vicinity of high frequency generators or arc welders; power supply lines must be separated from device input and output lines; always check that the supply voltage matches the voltage indicated on the device label.

• **Input and output connections:** external connected circuits must have double insulation; to connect analog inputs (TC, RTD) you have to: physically separate input wiring from power supply wiring, from output wiring, and from power connections; use twisted and screened cables, with screen connected to ground at only one point; to connect adjustment and alarm outputs (contactors, solenoid valves, motors, fans, etc.), install RC groups (resistor and capacitor in series) in parallel with inductive loads that work in AC (*Note: all capacitors must conform to VDE standards (class x2) and support at least 220 VAC. Resistors must be at least 2W*); fit a 1N4007 diode in parallel with the coil of inductive loads that operate in DC.

GEFRAN spa will not be held liable for any injury to persons and/or damage to property deriving from tampering, from any incorrect or erroneous use, or from any use not conforming to the device specifications.

Set-up for 600V RRR0-1-T73 regulator

Set up for temperature probe Pt100 (ex Siemens QAE2120 130°C max.)

The regulator comes out of the factory preset with the corresponding values of the Siemens RWF40.000 and RWF50.2x

Verify wiring of the sensor

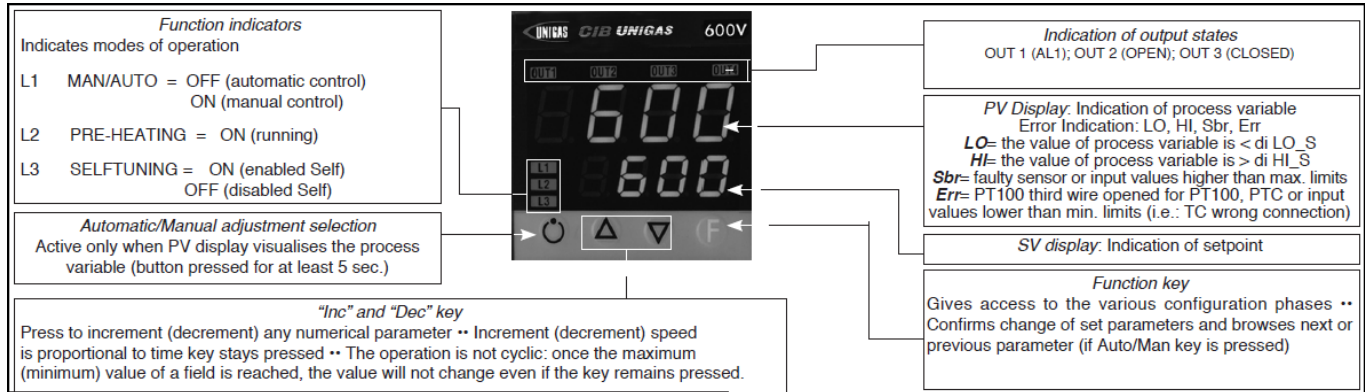

Regulation of the set-point = 80

It can be modified by using arrows "up" and "down".

By pushing F you go to parameters:

Hy.P	5 (hysteresis positive for output 1, terminals 21-22 (ex Q13-Q14))
Hy.n	-5 hysteresis negative for output ,1 terminals 21-22 (ex Q13-Q14)

Keep pushing F until you see **PASS**, release F and through the arrows set **99**, push F and visualize **Pro** (protection code) default is **12**, through the arrows set **128** and push F, keep it pushed until all parameters **InF**, **CFG**, **InP**, **Out**, **PASS** are visualized.

CFG	
S.tun	0
hPb	1,2
hIt	5,83
hdt	1,33
...	

InP	
....	
tyP	30 (Pt100)
...	
dP_S	1 (decimals num.)
Lo.S	0 (min. sensor scale)
Hi.S	850,0 (max sensor scale)
oFS	0 (offset of input correction)
Lo.L	30,0 (lower set-point range limit)
Hi.L	130,0 (upper set-point range limit)

Out	
A1.r	0
...	
A1.t	3 (operating mode AL1 =inverse-relative-normal)
...	
rL.1	2 (AL1)
rL.2	18 (open)
rL.3	19 (close)
rEL	0
A.ty	9 (type of servocontrol command)
Ac.t	12 (servocontrol running time: SQN72.4.../STA12..=12; SQM40.265=30)
t Lo	2
t Hi	0.0
t.on	2
t.oF	0.0
dE.b	0,1 (dead zone in % of end scale)

PAS	99 then push and keep pushed F until visualization of Hrd
Hrd	
...	
Ctrl	6 (PID warm)
AL.nr	1
but	1
diSP	0
Ld.1	1
Ld.2	28
Ld.3	20

Keep pushed **F** until you visualize **PASS**, release **F** and through the arrows set **99**, push **F** and visualize **Pro** (protection code) from **128**, through the arrows, bring it back to **12**, and keep **F** pushed until you come back to set-point value.

Manual operation :

Keep pushed the lower left key for at least 5 sec.

The instrument will enter the "MAN" mode (see also "Ld1" switching on).

Through the arrows, "Open" and "Close" outputs are activated.

To come back to normal working keep the lower left key pushed for at least 5 sec.

Software switch off :

By keeping pushed keys **Arrow up** + **F** for more than 5 sec. the instrument switches off the software, does not command the outputs and visualize only the variable of process measured by the probe.

To restore keep pushed **F** for more than 5 sec.

Set up for temperature probe Pt100 for high temperature (350°C max.)

Verify wiring of the sensor

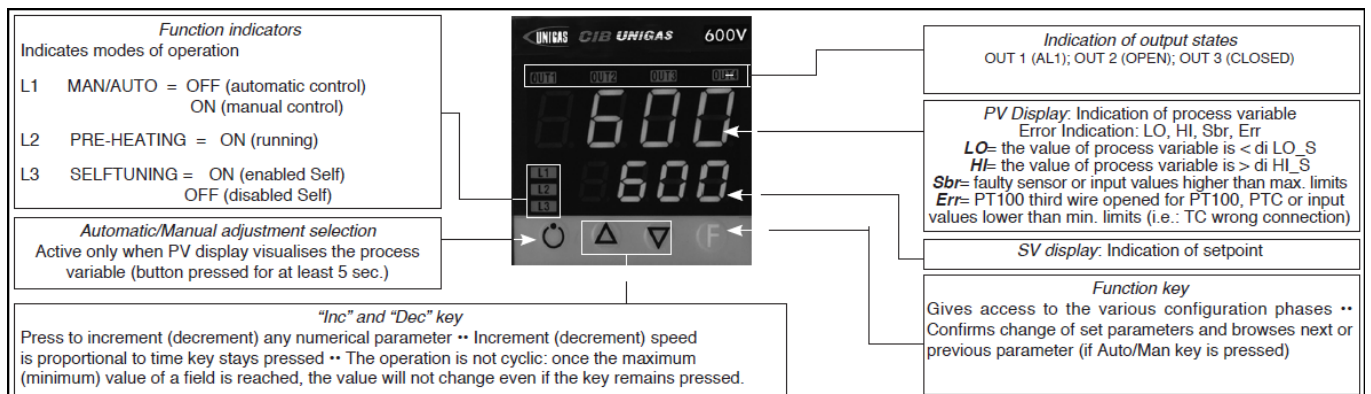

Regulation of the set-point = **80**

It can be modified by using arrows "up" and "down".

By pushing **F** you go to parameters:

Hy.P	10 (hysteresis positive for output 1 terminals 21-22 (ex Q13-Q14))
Hy.n	-5 (hysteresis negative for output 1 terminals 21-22 (ex Q13-Q14))

Keep pushing **F** until you see **PASS**, release **F** and through the arrows set **99**, push **F** and visualize **Pro** (protection code) default is **12**, through the arrows set **128** and push **F**, keep it pushed until all parameters **InF**, **CFG**, **InP**, **Out**, **PASS** are visualized.

CFG	
S.tun	0
hPb	1,2
hIt	5,83
hdt	1,33
...	

InP	
....	
tyP	30 (Pt100)
...	
dP_S	1 (decimals num.)
Lo.S	0 (min. sensor scale)
Hi.S	850,0 (max sensor scale)
oFS	0 (offset of input correction)
Lo.L	0,0 (lower set-point range limit)
Hi.L	350,0 (upper set-point range limit)

Out	
A1.r	0
...	
A1.t	3 (mode AL1 =inverse-relative-normal)
...	
rL.1	2 (AL1)
rL.2	18 (open)
rL.3	19 (close)
rEL	0
A.ty	9 (type of servocontrol command)
Ac.t	12 (servocontrol running time: SQN72.4.../STA12..=12; SQM40.265=30)
t Lo	2
t Hi	0.0
t.on	2
t.oF	0.0
dE.b	0,1 (dead zone in % of end scale)

PAS	99 then push and keep pushed F until visualization of Hrd
Hrd	
...	
Ctrl	6 (PID warm)
AL.nr	1
but	1
diSP	0
Ld.1	1
Ld.2	28
Ld.3	20

Keep pushed **F** until you visualize **PASS**, release **F** and through the arrows set **99**, push **F** and visualize **Pro** (protection code) from **128**, through the arrows, bring it back to **12**, and keep **F** pushed until you come back to set-point value.

Manual operation:

Keep pushed the lower left key for at least 5 sec.

The instrument will enter the "MAN" mode (see also "Ld1" switching on).

Through the arrows, "Open" and "Close" outputs are activated.

To come back to normal working keep the lower left key pushed for at least 5 sec.

Software switch off :

By keeping pushed keys **Arrow up** + **F** for more than 5 sec. the instrument switches off the software, does not command the outputs and visualize only the variable of process measured by the probe.

To restore keep pushed **F** for more than 5 sec.

Set up for pressure transmitter 2 wires signal 4÷20mA

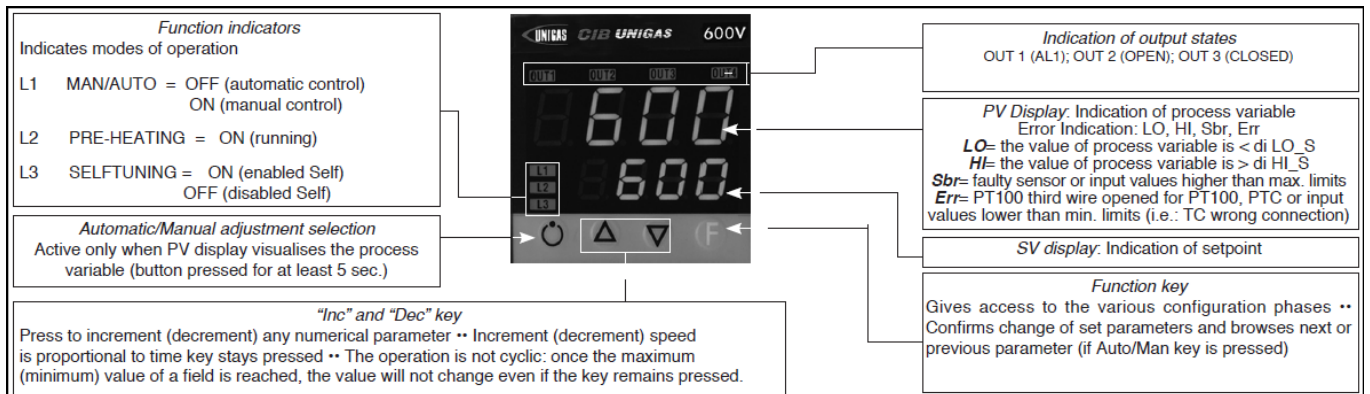

With pressure transmitters first we need to enable their power supply: remove the part as shown below, then, on the CPU unit, move the bridge from Pt100 to +Vt

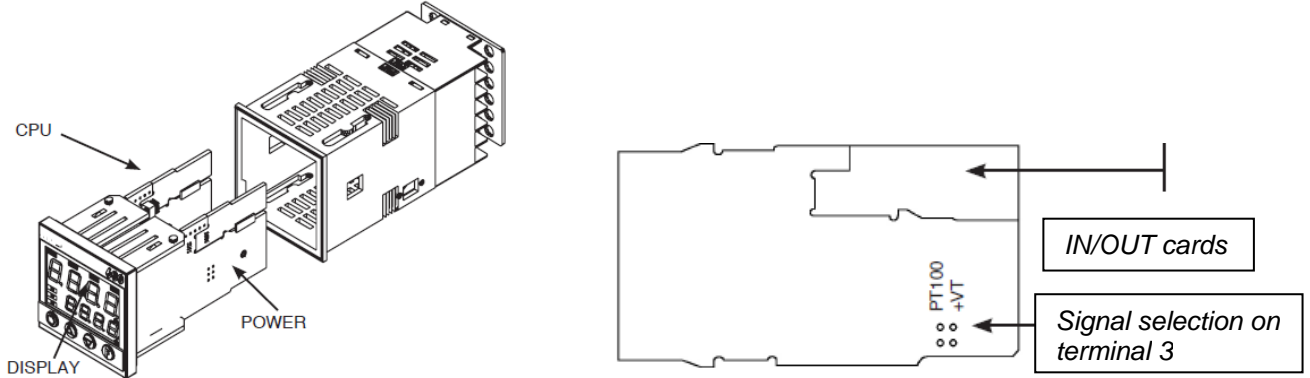

Verify wiring of the sensor

Impostazione set-point

Transmitter	1,6bar	3bar	10bar	16bar	25bar	40bar
Set-point	1bar	1,5bar	6bar	6bar	6bar	6bar

To modify it directly use "up" and "down" arrows.

By pushing **F** you go to parameter:

Transmitter	1,6bar	3bar	10bar	16bar	25bar	40bar
Hy.P	0,2bar	0,5bar	0,5bar	0,8bar	1,25bar	2bar
Hy.n	0bar	0bar	0bar	0bar	0bar	0bar

Keep pushing **F** until you see **PASS**, release **F** and through the arrows set **99**, push **F** and visualize **Pro** (protection code) default is **12**, through the arrows set **128** and push **F**, keep it pushed until all parameters **InF**, **CFG**, **InP**, **Out**, **PASS** are visualized.

CFG	
S.tun	0
hPb	5
hIt	1,33
hdt	0,33
...	

InP	
....	
tyP	44 (4÷20mA)
...	
dP_S	2 (decimals num.)

Transmitter	1,6bar	3bar	10bar	16bar	25bar	40bar	
Lo.S	0,00	0,00	0,00	0,00	0,00	0,00	min. sensor scale
Hi.S	1,60	3,00	10,00	16,00	25,00	40,00	max sensor scale
oFS	0	0	0	0	0	0	offset of input correction
Lo.L	0,00	0,00	0,00	0,00	0,00	0,00	lower set-point setting
Hi.L	1,60	3,00	10,00	16,00	25,00	40,00	upper set-point setting

Out	
A1.r	0
...	
A1.t	3 (mode AL1 =inverse-relative-normal)
...	
rL.1	2 (AL1)
rL.2	18 (open)
rL.3	19 (close)
rEL	0
A.ty	9 (type of servocontrol command)
Ac.t	12 (servocontrol running time: SQN72.4.../STA12..=12; SQM40.265=30)
t Lo	2
t Hi	0.0
t.on	2
t.oF	0.0
dE.b	0,1 (dead zone in % of end scale)

PAS	99 then push and keep pushed F until visualization of Hrd
Hrd	
...	
Ctrl	6 (PID warm)
AL.nr	1
but	1
diSP	0
Ld.1	1
Ld.2	28
Ld.3	20

Keep pushed **F** until you visualize **PASS**, release **F** and through the arrows set **99**, push **F** and visualize **Pro** (protection code) from **128**, through the arrows, bring it back to **12**, and keep **F** pushed until you come back to set-point value.

Manual operation:

Keep pushed the lower left key for at least 5 sec.

The instrument will enter the "MAN" mode (see also "Ld1" switching on).

Through the arrows, "Open" and "Close" outputs are activated.

To come back to normal working keep the lower left key pushed for at least 5 sec.

Software switch off :

By keeping pushed keys **Arrow up** + **F** for more than 5 sec. the instrument switches off the software, does not command the outputs and visualize only the variable of process measured by the probe.

To restore keep pushed **F** for more than 5 sec.

Set-up for thermocouples type **K** or **J**

Verify wiring of the sensor

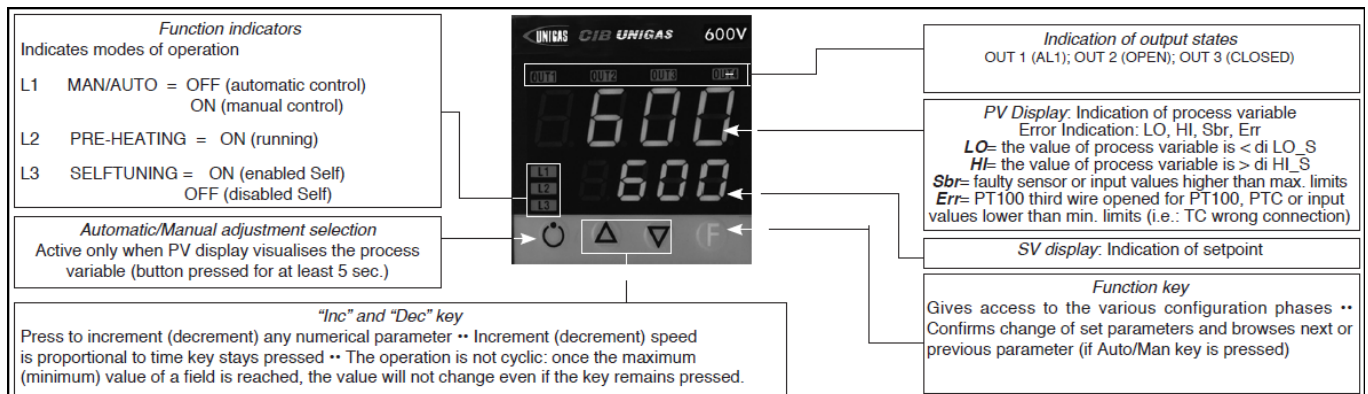

Regulation of the set-point = **80**

It can be modified by using arrows "up" and "down".

By pushing **F** you go to parameters:

Hy.P	10 (hysteresis positive for output 1 terminals 21-22 (ex Q13-Q14))
Hy.n	-5 (hysteresis negative for output 1 terminals 21-22 (ex Q13-Q14))

Keep pushing **F** until you see **PASS**, release **F** and through the arrows set **99**, push **F** and visualize **Pro** (protection code) default is **12**, through the arrows set **128** and push **F**, keep it pushed until all parameters **InF**, **CFG**, **InP**, **Out**, **PASS** are visualized.

CFG	
S.tun	0
hPb	1,2
hIt	5,83
hdt	1,33
...	

InP	
....	
tyP	2 (thermocouple K 0÷1300°C) / 0 (thermocouple J 0÷1000°C)
...	
dP_S	0 (no decimal) / 1 (1 decimal)
Lo.S	0 (min. sensor scale)
Hi.S	1300 (max sensor scale for tc K) / 1000 (max sensor scale for tc J)
oFS	0 (offset of input correction)
Lo.L	0 (lower set-point range limit)
Hi.L	1300 (upper set-point range limit) per tc K / 1000 for tc J

Out	
A1.r	0
...	
A1.t	3 (mode AL1 =inverse-relative-normal)
...	
rL.1	2 (AL1)
rL.2	18 (open)
rL.3	19 (close)
rEL	0
A.ty	9 (type of servocontrol command)
Ac.t	12 (servocontrol running time: SQN72.4.../STA12..=12; SQM40.265=30)
t Lo	2
t Hi	0.0
t.on	2
t.oF	0.0
dE.b	0,1 (dead zone in % of end scale)

PAS	99 then push and keep pushed F until visualization of Hrd
...	
Hrd	
...	
Ctrl	6 (PID warm)
AL.nr	1
but	1
diSP	0
Ld.1	1
Ld.2	28
Ld.3	20

Keep pushed **F** until you visualize **PASS**, release **F** and through the arrows set **99**, push **F** and visualize **Pro** (protection code) from **128**, through the arrows, bring it back to **12**, and keep **F** pushed until you come back to set-point value.

Manual operation:

Keep pushed the lower left key for at least 5 sec.

The instrument will enter the "MAN" mode (see also "Ld1" switching on).

Through the arrows, "Open" and "Close" outputs are activated.

To come back to normal working keep the lower left key pushed for at least 5 sec.

Software switch off :

By keeping pushed keys **Arrow up** + **F** for more than 5 sec. the instrument switches off the software, does not command the outputs and visualize only the variable of process measured by the probe.

To restore keep pushed **F** for more than 5 sec.

RWF50.2x & RWF50.3x



User manual

DEVICE INSTALLATION

Install the device using the relevant tools as shown in the figure.

To wire the device and sensors, follow the instructions on the burner wiring diagram.

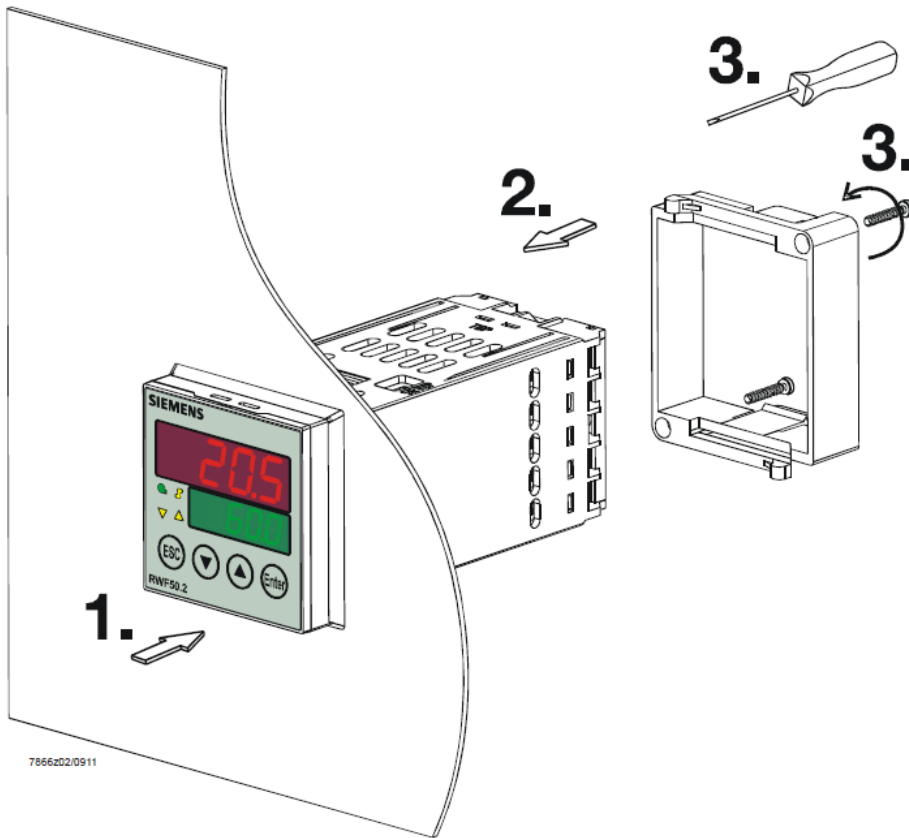

7866202/0911

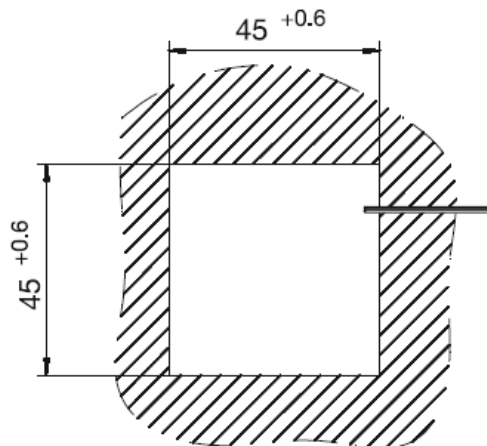

FRONT PANEL

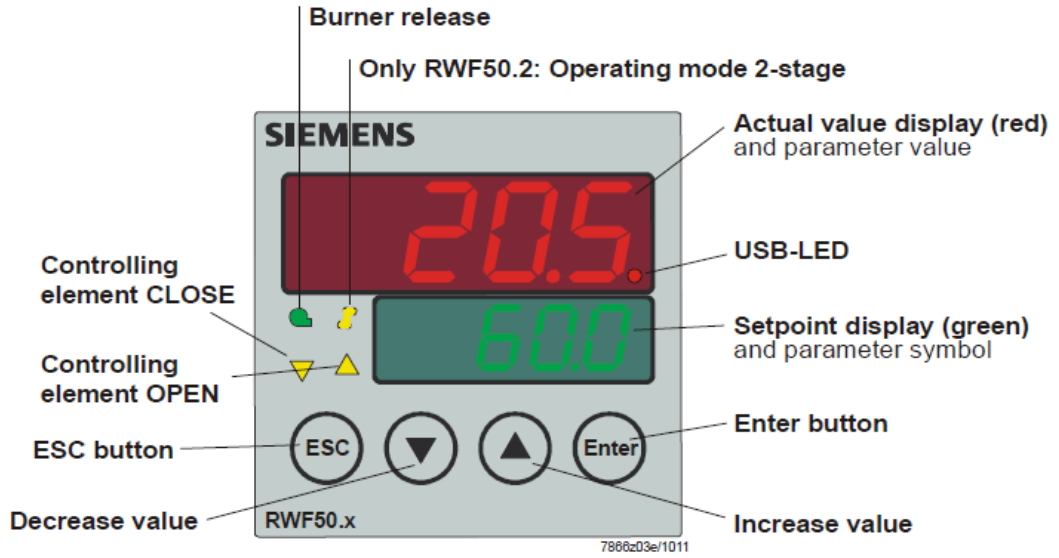

NAVIGATION MENU

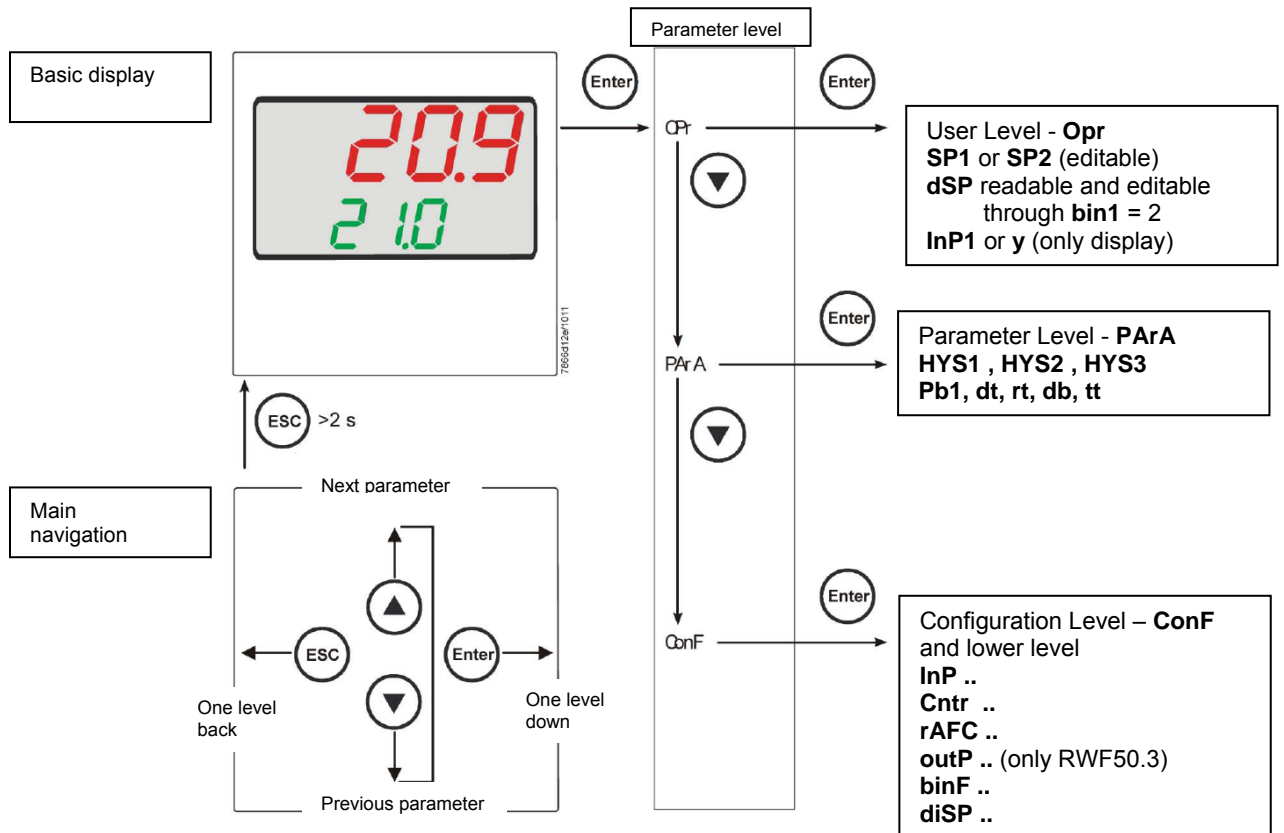

RWF5 is preset good for 90% of applications. However, you can set or edit parameters as follow:

Set-point: set or modification:

When the burner is in stand-by, (safety loop open, that is terminals 3-4/T1-T2 on the 7 pole plug open) push the **Enter** button: on the lower display (green) **Opr** appears; push **Enter** again and in the same display **SP1** appears. Push **Enter** again and the lower display (green **SP1**) flashes. Using the **up and down arrows** change the set-point on the upper display (red). Push **Enter** to confirm and push **ESC** more times to get the home position.

PID parameters set and modifications (see table below):

- Push **Enter** button, on the green display **Opr** appears; using the **down arrow**, scroll until group **PARA** is reached and push **Enter**.
- on the green display **Pb1** e appears and on the red one the set parameter.
- Push in sequence the **down or up** arrow the menu is scrolled.
- Push **Enter** to select and the **arrows** to choose the desired value. **Enter** to confirm.

Parameter	Display	Range	Factory setting	Remarks
Proportional band	PB.1	1... 9999 digit	10	Typical value for temperature
Derivative action	dt	0... 9999 sec.	80	Typical value for temperature
Integral action	rt	0... 9999 sec.	350	Typical value for temperature
Dead band (*)	db	0... 999,9 digit	1	Typical value
Servocontrol running time	tt	10... 3000 sec.	15	Set servocontrol running time
Switch-on differential (*)	HYS1	0,0... -1999 digit	-5	Value under setpoint below which the burner switches back on (1N-1P closes)
Switch-off differential 2° stage (*)	HYS2	0,0 ... HYS3	3	(enable only with parameter bin1 = 4)
Upper switch-off differential (*)	HYS3	0,0... 9999 digit	5	Value over setpoint above which the burner switches off (1N-1P opens)
Switch-on differential on cooling controller (*)	HYS4	0,0... 9999 digit	5	Do not used (enable only with parameter CACT = 0)
Switch-off differential 2° stage on cooling controller (*)	HYS5	HYS6...0,0 digit	5	Do not used (enable only with parameters CACT = 0 and bin1 = 4)
Upper switch-off differential on cooling controller (*)	HYS6	0,0... -1999 digit	5	Do not used (enable only with parameter CACT = 0)
Delay modulation	q	0,0... 999,9 digit	0	Do not alter

(*)Parameters affected by setting of decimal place (**ConF > dISP** parameter **dECP**)

Setting the kind of sensor to be connected to the device:

- push the **Enter** button: on the lower display (green) **Opr** appears. Using the **up and down arrows** find **ConF**. Push **Enter** to confirm.
- Now on the green display the group **InP** appears. Push **Enter** and **InP1** is displayed. Enter to confirm.
- You are inside **InP1**; the green display shows **Sen1 (sensor type)**, while the red display shows the chosen sensor code
- Push **Enter** to enter the **Sen1** parameter, then choose the desired sensor using the **arrows**. Push **Enter** to confirm and **ESC** to escape.
- Once selected the sensor, you can modify all the other parameters using **up and down arrows** according to the tables here below.

ConF > InP > InP1

Parameter	Value	Description
SEn1 type of sensor for analog input 1	1	Pt100 3 fili
	2	Pt100 2 fili
	3	Pt1000 3 fili
	4	Pt1000 2 fili
	5	Ni1000 3 fili
	6	Ni1000 2 fili
	7	0 ÷ 135 ohm
	15	0 ÷ 20mA
	16	4 ÷ 20mA
	17	0 ÷ 10V
	18	0 ÷ 5V
	19	1 ÷ 5V
OFF1 sensor offset	-1999.. 0 .. +9999	Using the measured value correction (offset), a measured value can be corrected to a certain degree, either up or down
SCL1 scale low level	-1999.. 0 .. +9999	In the case of a measuring transducer with standard signal, the physical signal is assigned a display value here (for input ohm, mA, V)
SCH1 scale high level	-1999.. 100 .. +9999	In the case of a measuring transducer with standard signal, the physical signal is assigned a display value here (for input ohm, mA, V)
dF1 digital filter	0.. 0,6 ...100	Is used to adapt the digital 2nd order input filter (time in s; 0 s = filter off)
Unit temperature unit	1 2	1 = degrees Celsius 2 = degrees Fahrenheit

(**bold** = factory settings)

Remark:

RWF50.2 e RWF50.3 cannot be connected to thermocouples.
If thermocouples have to be connected, convert the signal to a 4-20 mA one and set the RWF accordingly.

ConF > Cntr

Parameter	Value	Description
CtYP controller type	1 2	1 = 3-position controller (open-stop-close only RWF50.2) 2 = continuative action controller (only RWF50.3)
CACt control action	1 0	1 = heating controller 0 = cooling controller
SPL least value of the set-point range	-1999.. 0 ..+9999	set-point limitation prevents entry of values outside the defined range
SPH maximum value of the set-point range	-1999.. 100 ..+9999	set-point limitation prevents entry of values outside the defined range
oLLo set-point limitation start, operation limit low	-1999 +9999	lower working range limit
oLHi set-point limitation end, operation limit high	-1999.... +9999	upper working range limit

(**bold** = factory settings)

ConF > rAFC

Activation boiler shock termic protetion:

RWF50.. can activate the thermal shock protection only on sites where the set-point is lower than 250°C and according to **rAL** parameter.

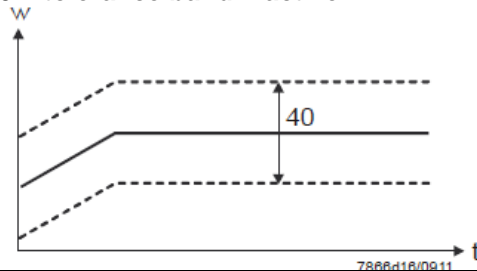
Parameter	Value	Description
FnCT function	0 1 2	Choose type of range degrees/time 0 = deactivated 1 = Kelvin degrees/minute 2 = Kelvin degrees/hour
rASL ramp rate	0,0 ... 999,9	Slope of thermal shock protection (only with functions 1 and 2)
toLP tolerance band ramp	0 ...9999	width of tolerance band (in K) about the set-point 0 = tolerance band inactive 
rAL ramp limit	0 ...250	Ramp limit. When this value is lower than the temperature set-point, the RWF controls the output increasing the temp set point step by step according to rASL. If this is over the temp set point, the control is performed in cooling.

(**bold** = factory settings)

ConF > OutP (parameter under group only for RWF50.3)

Parameter	Value	Description
FnCt tipo di controllo	1 4	1 = analog input 1 doubling with possibility to convert (depending on par SiGn) 4 = modulation controller
SiGn type of output signal	0 1 2	physical output signal (terminals A+, A-) 0 = 0÷20mA 1 = 4÷20mA 2 = 0÷10V
rOut Value when out of input range	0...101	signal (in percent) when measurement range is crossed
oPnt zero point	-1999... 0 ..+9999	value range of the output variable is assigned to a physical output signal Per default, the setting corresponds to 0...100% angular positioning for the controller outputs (terminals A+, A-) (effective only with FnCt = 1)
End End value	-1999... 100 ..+9999	value range of the output variable is assigned to a physical output signal Per default, the setting corresponds to 0...100% angular positioning for the controller outputs (terminals A+, A-) (effective only with FnCt = 1)

(**bold** = factory settings)

ConF > binF

Parameter	Value	Description
bin1 digital inputs (terminals DG - D1)	0 1 2 4	0 = without function 1 = set-point changeover (SP1 / SP2) 2 = set-point shift (Opr > dSP parameter = value of set-point modify) 4 = changeover of operating mode open – modulating operation; close – 2 stage operation.

(**bold** = factory settings)

ConF > dISP

Parameter	Value	Description
diSU upper display (red)	0 1 4 6 7	display value for upper display: 0 = display power-off 1 = analog input value 4 = Controller's angular positioning 6 = set-point value 7 = end value with thermal shock protection
diSL lower display (green)	0 1 4 6 7	display value for lower display: 0 = display power-off 1 = analog input value 4 = Controller's angular positioning 6 = set-point value 7 = end value with thermal shock protection
tout timeout	0.. 180 ..250	time (s) on completion of which the controller returns automatically to the basic display, if no button is pressed
dECP decimal point	0 1 2	0 = no decimal place 1 = one decimal place 2 = two decimal places
CodE level lockout	0 1 2 3	0 = no lockout 1 = configuration level lockout (ConF) 2 = Parameter and configuration level lockout (PARa & ConF) 3 = keyboard lockout

(**bold** = factory settings)

Manual control :

- in order to manual change the burner load, while firing keep pushing the **ESC** button for more than 5 s; on the lower green display **Hand** appears.
- using the **UP** and **DOWN** arrows, the load varies.
- Keep pushing the **ESC** button for getting the normal operation again.
- **NB:** every time the device shuts the burner down (start led switched off - contact 1N-1P open), the manual control is not active.

Device self-setting (auto-tuning):

If the burner in the steady state does not respond properly to heat generator requests, you can activate the Device's self-setting function, which recalculates PID values for its operation, deciding which are most suitable for the specific kind of request



Follow the below instructions:
push the **UP** and **DOWN** arrows for more than 5 s; on the green lower display **TUNE** appears. Now the device pushes the burner to increase and decrease its output. During this time, the device calculates PID parameters (**Pb1**, **dt** and **rt**). After the calculations, the TUNE is automatically deactivated and the device has already stored them.
In order to stop the Auto-tuning function while it works, push again the **UP** and **DOWN** arrows for more than 5 s. The calculated PID parameters can be manually modified following the previously described instructions.

Display of software version :

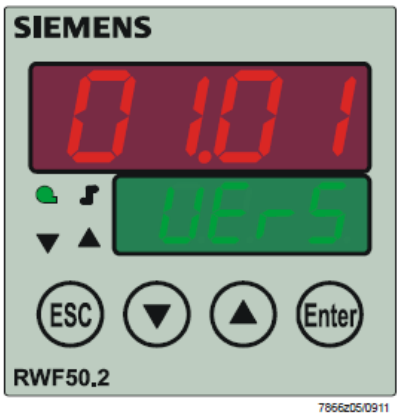

The software version is shown by pushing **Enter + UP arrow** on the upper display

Electric connection :

With 7 pins connector version

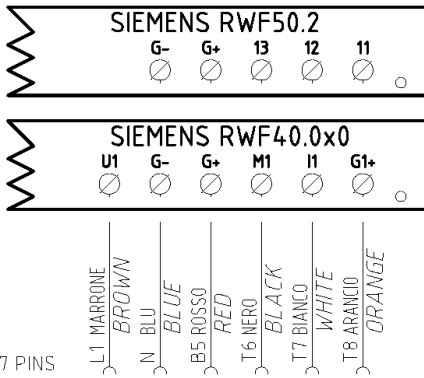

CONN. 7 PINS

With terminals version

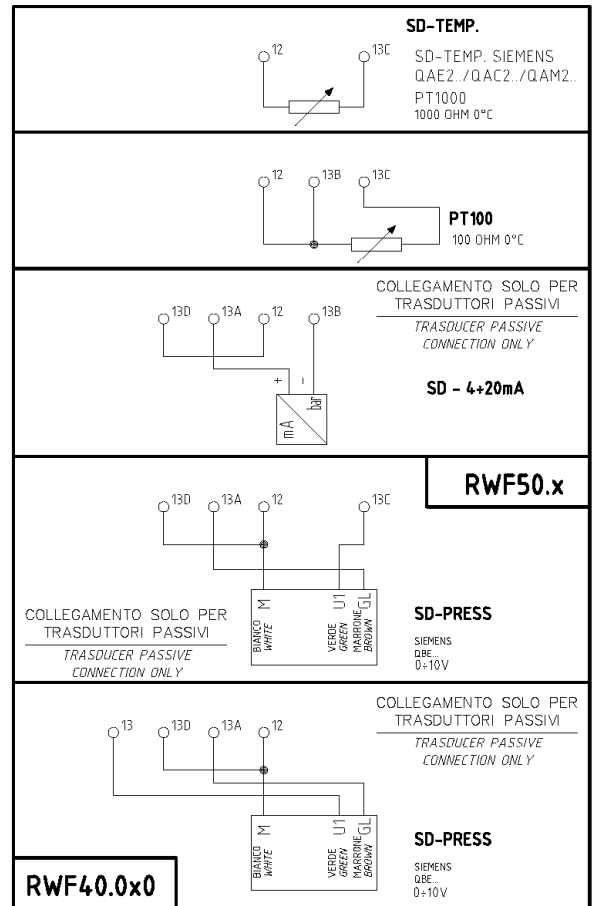
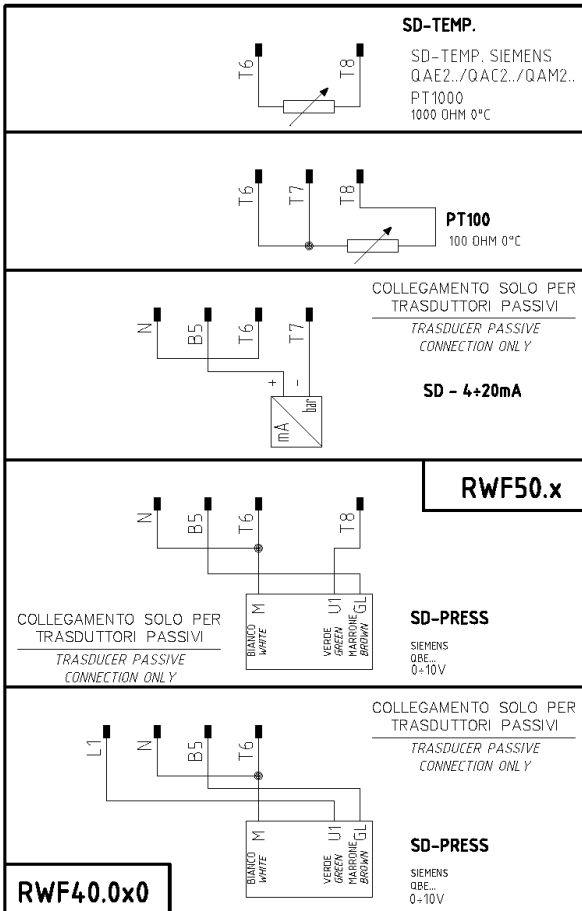
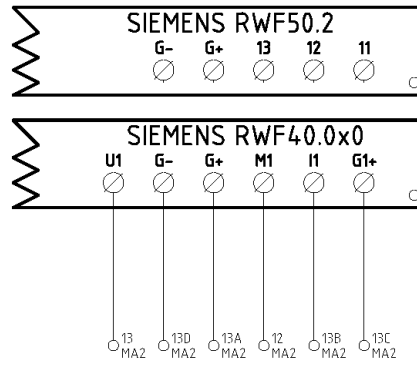

Matches terminals between RWF50.2 and RWF40.0x0

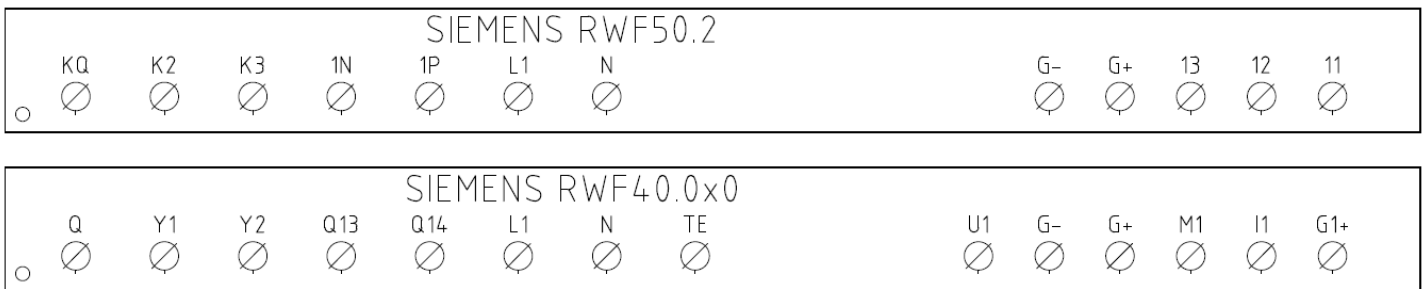

Parameters summarising for RWF50.2x:

Navigation menù	Conf Inp					Conf			PArA					Opr	
	Inp1					Cntr		diSP							
Types of probe	SEn1	OFF1	SCL	SCH	Unit	SPL	SPH	dECP	Pb. 1	dt	rt	tt	HYS1 (*)	HYS3 (*)	SP1 (*)
Siemens QAE2120...	6	0	needless	needless	1	30	95	1	10	80	350 (#)		-5	5	80 °C
Siemens QAM2120..	6	0	needless	needless	1	0	80	1	10	80	350 (#)		-2.5	2.5	40°C
Pt1000 (130°C max.)	4	0	needless	needless	1	30	95	1	10	80	350 (#)		-5	5	80°C
Pt1000 (350°C max.)	4	0	needless	needless	1	0	350	1	10	80	350 (#)		-5	10	80°C
Pt100 (130°C max.)	1	0	needless	needless	1	0	95	1	10	80	350 (#)		-5	5	80°C
Pt100 (350°C max)	1	0	needless	needless	1	0	350	1	10	80	350 (#)		-5	10	80°C
Sonda 4÷20mA / 0÷1,6bar	16	0	0	160	needless	0	160	0	5	20	80 (#)		0	20	100 kPa
Sonda 4÷20mA / 0÷10bar	16	0	0	1000	needless	0	1000	0	5	20	80 (#)		0	50	600 kPa
Sonda 4÷20mA / 0÷16bar	16	0	0	1600	needless	0	1600	0	5	20	80 (#)		0	80	600 kPa
Sonda 4÷20mA / 0÷25bar	16	0	0	2500	needless	0	2500	0	5	20	80 (#)		0	125	600 kPa
Sonda 4÷20mA / 0÷40bar	16	0	0	4000	needless	0	4000	0	5	20	80 (#)		0	200	600 kPa
Sonda 4÷20mA / 0÷60PSI	16	0	0	600	needless	0	600	0	5	20	80 (#)		0	30	300 (30PSI)
Sonda 4÷20mA / 0÷200PSI	16	0	0	2000	needless	0	2000	0	5	20	80 (#)		0	75	600 (60PSI)
Sonda 4÷20mA / 0÷300PSI	16	0	0	3000	needless	0	3000	0	5	20	80 (#)		0	120	600 (60PSI)
Siemens QBE2002 P4	17	0	0	400	needless	0	400	0	5	20	80 (#)		0	20	200 kPa
Siemens QBE2002 P10	17	0	0	1000	needless	0	1000	0	5	20	80 (#)		0	50	600 kPa
Siemens QBE2002 P16	17	0	0	1600	needless	0	1600	0	5	20	80 (#)		0	80	600 kPa
Siemens QBE2002 P25	17	0	0	2500	needless	0	2500	0	5	20	80 (#)		0	125	600 kPa
Siemens QBE2002 P40	17	0	0	4000	needless	0	4000	0	5	20	80 (#)		0	200	600 kPa
Segnale 0÷10V	17	0	to be fixed	to be fixed	needless	to be fixed	to be fixed	to be fixed	5	20	80 (#)		to be fixed	to be fixed	to be fixed
Segnale 4÷20mA	16	0	to be fixed	to be fixed	needless	to be fixed	to be fixed	to be fixed	5	20	80 (#)		to be fixed	to be fixed	to be fixed

NOTE : (#) tt - Types of probe

SQL33 ; STM30; SQM10; SQM40; SQM50; SQM54 = 30 (second) - STA12B3.41; SQN30.251; SQN72.4A4A20 = 12 (second)

(*) These values are factory set - values **MUST BE** set during operation at the plant based on the real working temperature/pressure value.

WARNING : With pressure probes the parameters SP1, SCH, SCL, HYS1, HYS3 must be selected, and visualized in kPa (kilo Pascal). (1bar = 100.000Pa = 100kPa).

TABLE OF PARAMETERS TO BE MODIFIED FOR CALIBRATIONS RWF50.3x/RWF55.xx (CONTINUOUS OUTPUT 4÷20mA) INSTEAD OF 3 POINTS

Navigation menù	Conf OutP				
Parameter	FnCt	SiGn	rOut	OPnt	End
	4	1 (4÷20mA)	0	0	100

NOTE : (#) tt - servocontrol travel time

SQL33 ; STM30; SQM10; SQM40; SQM50; SQM54 = 30 (second)

STA12B3.41; SQN30.251; SQN72.4A4A20 = 12 (second)

(*) Factory-set values, these values must be varied according to the actual working temperature/pressure of the system.

WARNING : With pressure probes in bar, parameters SP1, SCH, SCL, HYS1, HYS3 must be set, and displayed in kPa (kilo Pascal); 1bar = 100,000Pa = 100kPa.
With pressure probes in PSI the parameters SP1, SCH, SCL, HYS1, HYS3 must be set, and displayed in PSI x10 (example : 150PSI > display 1500).

APPENDIX: PROBES CONNECTION

To assure the utmost comfort, the control system needs reliable information, which can be obtained provided the sensors have been installed correctly. Sensors measure and transmit all variations encountered at their location.

Measurement is taken based on design features (time constant) and according to specific operating conditions. With wiring run in raceways, the sheath (or pipe) containing the wires must be plugged at the sensor's terminal board so that currents of air cannot affect the sensor's measurements.

Ambient probes (or ambient thermostats)

Installation

The sensors (or room thermostats) must be located in reference rooms in a position where they can take real temperature measurements without being affected by foreign factors.

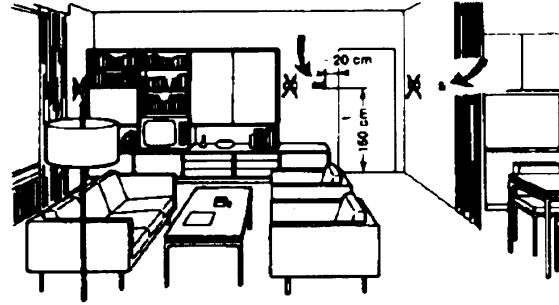
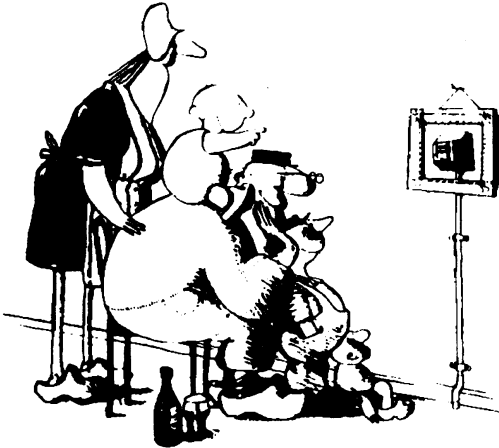

Outside probes (weather)

Installation

In heating or air-conditioning systems featuring adjustment in response to outside temperature, the sensor's positioning is of paramount importance.

It's good to be admired ...even better to be effective

Heating systems: the room sensor must not be installed in rooms with heating units complete with thermostatic valves. Avoid all sources of heat foreign to the system.

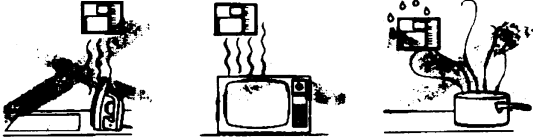

General rule: on the outer wall of the building where the living rooms are, never on the south-facing wall or in a position where they will be affected by morning sun. If in any doubt, place them on the north or north-east façade.

Location

On an inner wall on the other side of the room to heating units height above floor 1.5 m, at least 1.5 m away from external sources of heat (or cold).

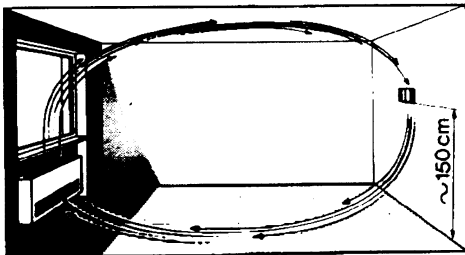

Installation position to be avoided

near shelving or alcoves and recesses, near doors or windows, inside outer walls exposed to solar radiation or currents of cold air, on inner walls with heating system pipes, domestic hot water pipes, or cooling system pipes running through them.

Positions to be avoided

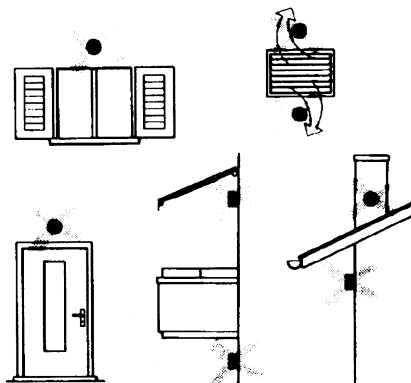

Avoid installing near windows, vents, outside the boiler room, on chimney breasts or where they are protected by balconies, cantilever roofs.

The sensor must not be painted (measurement error).

Duct or pipe sensors

Installing temperature sensors

For measuring outlet air:

- after delivery fan or
- after coil to be controlled, at a distance of at least 0,5 m

For measuring room temperature:

- before return air intake fan and near room's return airintake. For measuring saturation temperature: after mist eliminator.

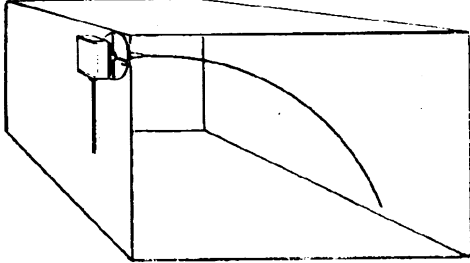

Bend 0.4m sensor by hand (never use tools) as illustrated.

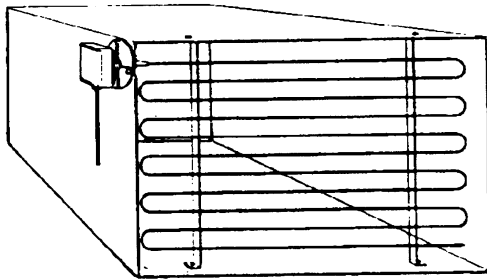

Use whole cross-section of duct, min. distance from walls 50 mm, radius of curvature 10 mm for 2m or 6m sensors.

Installing combined humidity sensors

As max. humidity limit sensor on outlet (steam humidifiers).

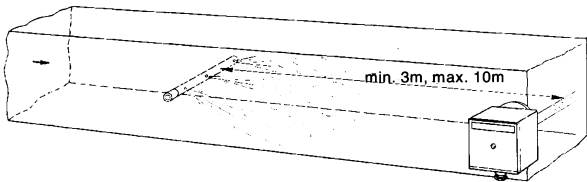

Installing pressure sensors

A - installation on ducts carrying fluids at max. temperature 80°C

B - installation on ducts at temperature over 80°C and for refrigerants

C - installation on ducts at high temperatures:

- increase length of siphon
- place sensor at side to prevent it being hit by hot air coming from the pipe.

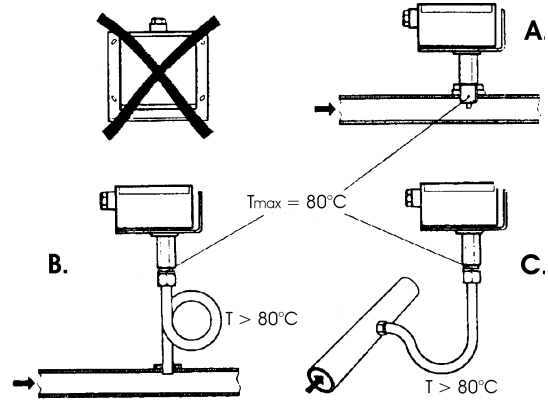

Installing differential pressure sensors for water

- Installation with casing facing down not allowed.-With temperature over 80°C, siphons are needed.
- To avoid damaging the sensor, you must comply with the following instructions

when installing:

- make sure pressure difference is not greater than the value permitted by the sensor
- when there are high static pressures, make sure you insert shutoff valves A-B-C.

Putting into operation

Start disable

1=open C1=open C

2=open A2=close B

3=open B3=close A

4= close C

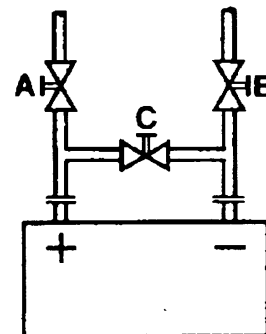

Immersion or strap-on sensors

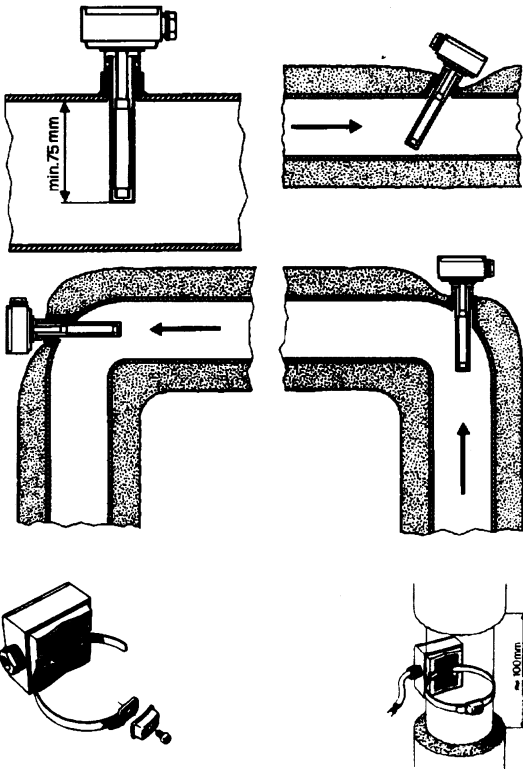

Immersion probes installation

Sensors must be installed on the stretch of pipe in which fluid circulates all the time.

The rigid stem (sensing element doing the measuring) must be inserted by at least 75mm and must face the direction of flow.

Recommended locations: on a bend or on a straight stretch of pipe but tilted by 45° and against the flow of fluid.

Protect them to prevent water from infiltrating (dripping gates, condensation from pipes etc.)

Installing QAD2.. strap-on sensors

Make sure fluid is circulating in the chosen location.

Eliminate insulation and paintwork (including rust inhibitor) on a min. 100mm length of pipe.

Sensors come with straps for pipes up to 100 mm in diameter

Placing the probes (QAD22.../QAE21.../QAP21.../RCA...)

With pumps on outlet

with 3 ways valves / with 4 ways valves



Panel system / burner control

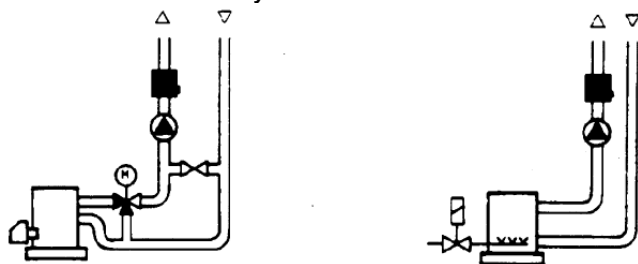

With pumps on return

with 3 ways valves / with 4 ways valves



Strap-on or immersion sensors?

QAD2.. strap-on sensors

Advantages :

- 10 sec. time constant
- Installed with system running (no plumbing work)
- Installation can be changed easily if it proves incorrect.

Limits:

- Suitable for pipe diameters max. 100 mm
- Can be affected by currents of air etc.

QAE2... immersion sensors

Advantages:

- Measure "mean" fluid temperature
- No external influence on measurement such as: currents of air, nearby pipes etc.

Limits:

- Time constant with sheath: 20 sec.
- Hard to change installation position if it proves incorrect.

Duct pressure switches and sensors

Installing differential pressure probes for air

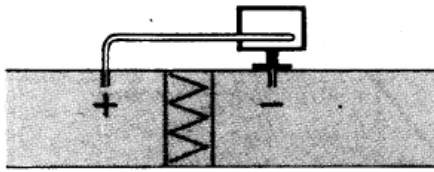

A - Control a filter (clogging)

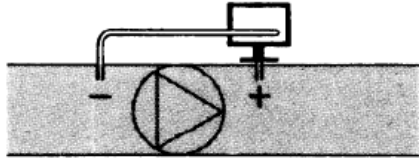

B - Control a fan (upstream/downstream)

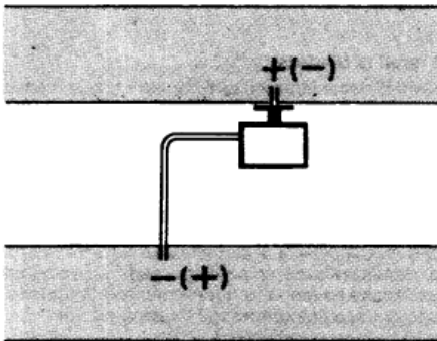

C - Measurement of difference in pressure between two ducts

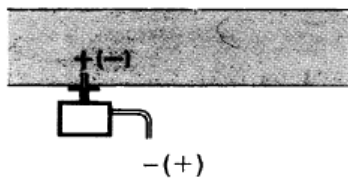

D - Measurement of difference in pressure between two rooms or of inside of duct and outside

Basic principles

Measuring static pressure (i.e. pressure exerted by air on pipe walls)

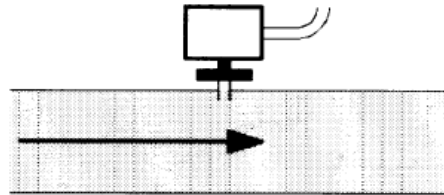

Measuring dynamic pressure

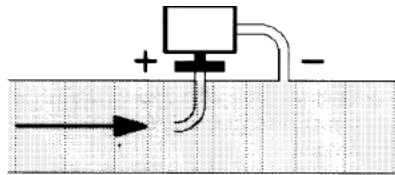

$$Pd = \frac{\gamma v^2}{2g}$$

Key

- γ Kg/m³, specific weight of air
- v m/s, air speed
- g 9.81 m/s² gravity acceleration
- Pd mm C.A., dynamic pressure

Measuring total pressure

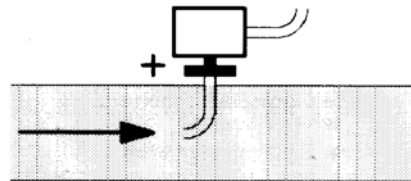

Spare parts

Description	Code
Modulator RWF50.2 (uscita a 3 punti - apri, fermo, chiudi) 2570148	2570148
Modulator RWF50.3 (uscita continua 0÷20mA, 4÷20mA, 0÷10V) 2570149	2570149
Temperature probe Siemens QAE2120.010A (30÷130°C) 2560101	2560101
Temperature probe Siemens QAM2120.040 (-15÷+50°C) 2560135	2560135
Thermoresistor Pt1000 ø6mm L100mm (30÷130°C) 2560188	2560188
Thermoresistor Pt1000 ø10mm L200mm (0÷350°C) 2560103	2560103
Thermoresistor Pt100 ø10mm L200mm (0÷350°C) 2560145	2560145
Thermoresistor Pt100 ø8mm L85mm (0÷120°C) 25601C3	25601C3
Pressure probe Siemens QBE2.. P4 (0÷4bar) 2560159	2560159
Pressure probe Siemens QBE2.. P10 (0÷10bar / signal 0÷10V) 2560160	2560160
Pressure probe Siemens QBE2.. P16 (0÷16bar / signal 0÷10V) 2560167	2560167
Pressure probe Siemens QBE2.. P25 (0÷25bar / signal 0÷10V) 2560161	2560161
Pressure probe Siemens QBE2.. P40 (0÷40bar / signal 0÷10V) 2560162	2560162
Pressure probe Danfoss MBS 3200 P 1,6 (0÷1,6bar / signal 4÷20mA) 2560189	2560189
Pressure probe Danfoss MBS 3200 P 10 (0÷10bar / signal 4÷20mA) 2560190	2560190
Pressure probe Danfoss MBS 3200 P 16 (0÷16bar / signal 4÷20mA) 2560191	2560191
Pressure probe Danfoss MBS 3200 P 25 (0÷25bar / signal 4÷20mA) 2560192	2560192
Pressure probe Danfoss MBS 3200 P 40 (0÷40bar / signal 4÷20mA) 2560193	2560193
Pressure probe Siemens 7MF1565-3BB00-1AA1 (0÷1,6bar / signal 4÷20mA) 25601A3	25601A3
Pressure probe Siemens 7MF1565-3CA00-1AA1 (0÷10bar / signal 4÷20mA) 25601A4	25601A4
Sonda di pressione Siemens 7MF1565-3CB00-1AA1 (0÷16bar / signal 25601A5	25601A5
Pressure probe Siemens 7MF1565-3CD00-1AA1 (0÷25bar / signal 4÷20mA) 25601A6	25601A6
Pressure probe Siemens 7MF1565-3CE00-1AA1 (0÷40bar / signal 4÷20mA) 25601A7	25601A7
Pressure probe Gefran E3E B1V6 MV (0÷1,6bar / segnale 4÷20mA) 25601C4	25601C4
Pressure probe Danfoss E3E B01D MV (0÷10bar / segnale 4÷20mA) 25601C5	25601C5
Pressure probe Danfoss E3E B16U MV (0÷16bar / segnale 4÷20mA) 25601C6	25601C6
Pressure probe Danfoss E3E B25U MV (0÷25bar / segnale 4÷20mA) 25601C7	25601C7
Pressure probe Danfoss E3E B04D MV (0÷40bar / segnale 4÷20mA) 25601C8	25601C8
Pressure probe Siemens 7MF1567-4CD00-1EA1 (0-300PSI 1/4NPT 4-20mA)	25601G0
Pressure probe Siemens 7MF1567-4BF00-1EA1 (0-60PSI 1/4NPT 4-20mA)	25601G1
Pressure probe Siemens 7MF1567-4CB00-1EA1 (0-200PSI 1/4NPT 4-20mA)	25601G2

Note: Specifications and data subject to change. Errors and omissions excepted.

KM3 Modulator

USER MANUAL

MOUNTING

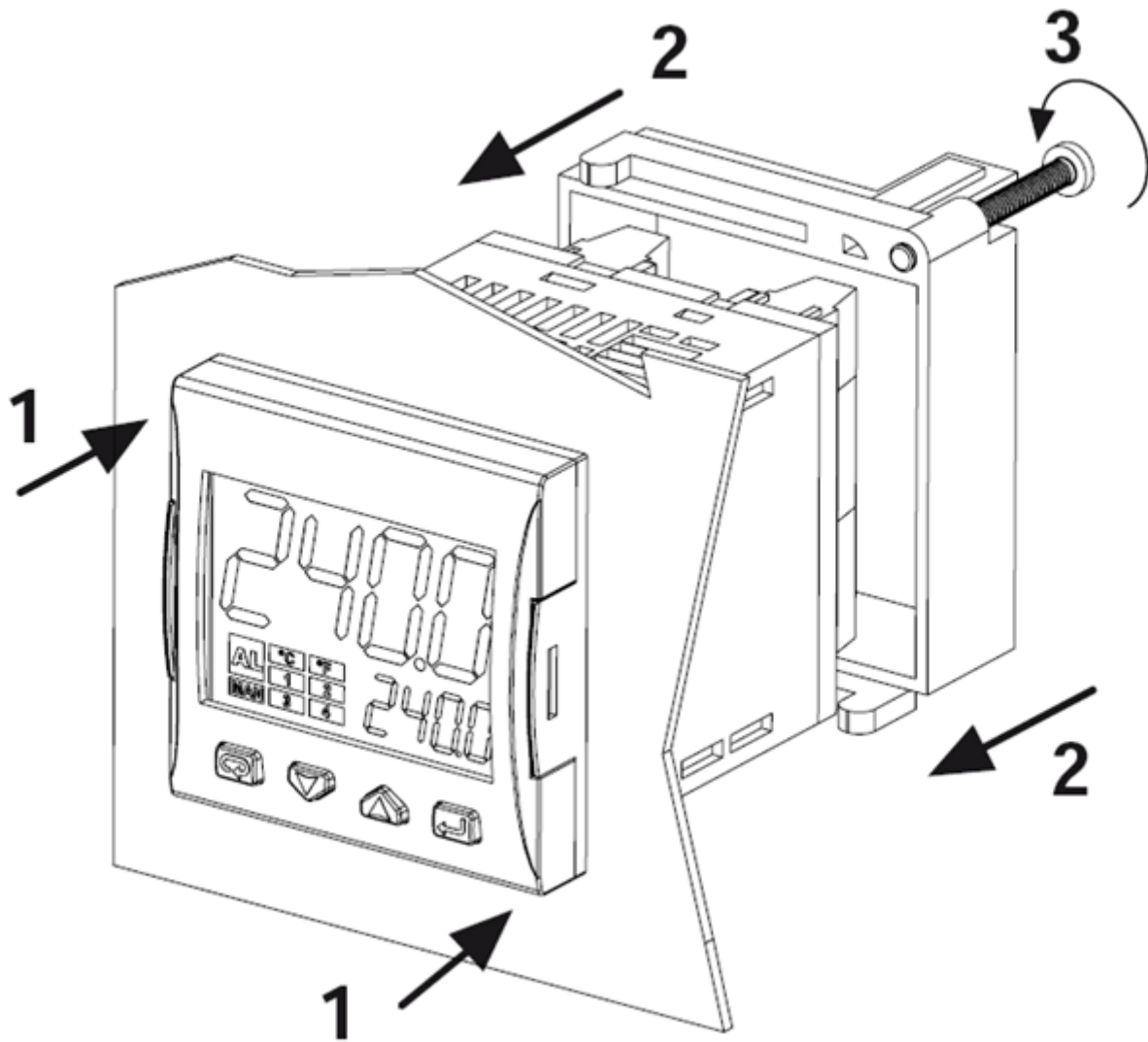

DISPLAY AND KEYS

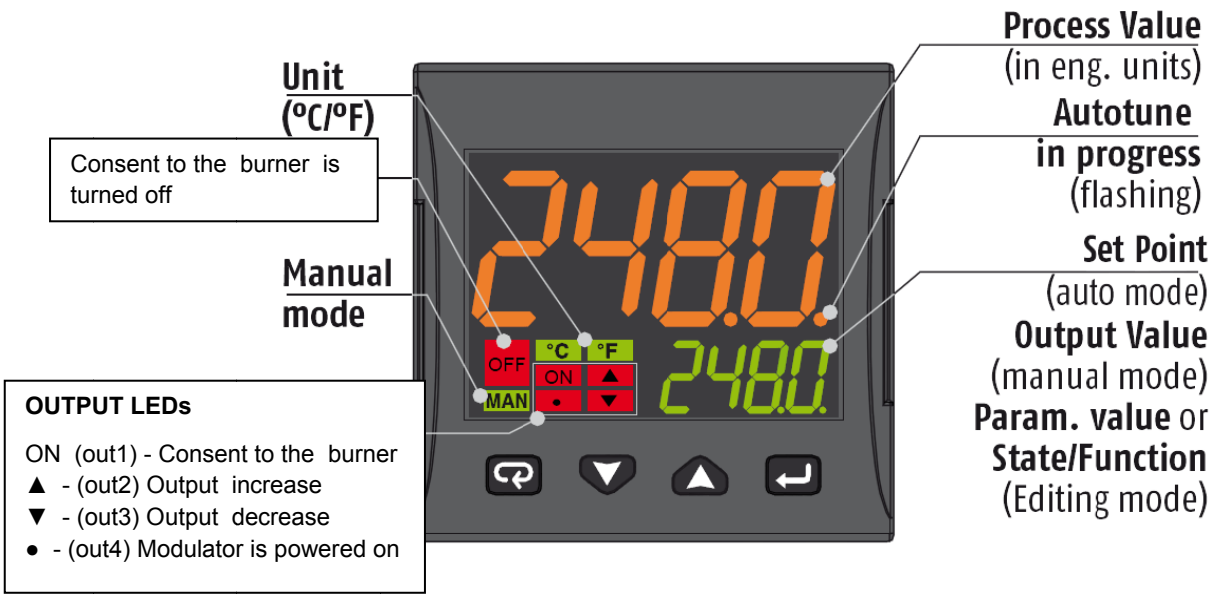

	Operator Mode	Editing Mode
	Access to: - Operator Commands (Timer, Setpoint selection ...) - Parameters - Configuration	Confirm and go to Next parameter
	Access to: - Operator additional information (Output value, running time ...)	Increase the displayed value or select the next element of the parameters list
	Access to: - Set Point	Decrease the displayed value or select the previous element
	Programmable key: Start the programmed function (Autotune, Auto/Man, Timer ...)	Exit from Operator commands/Parameter setting/Configuration

CONNECTIONS DIAGRAM

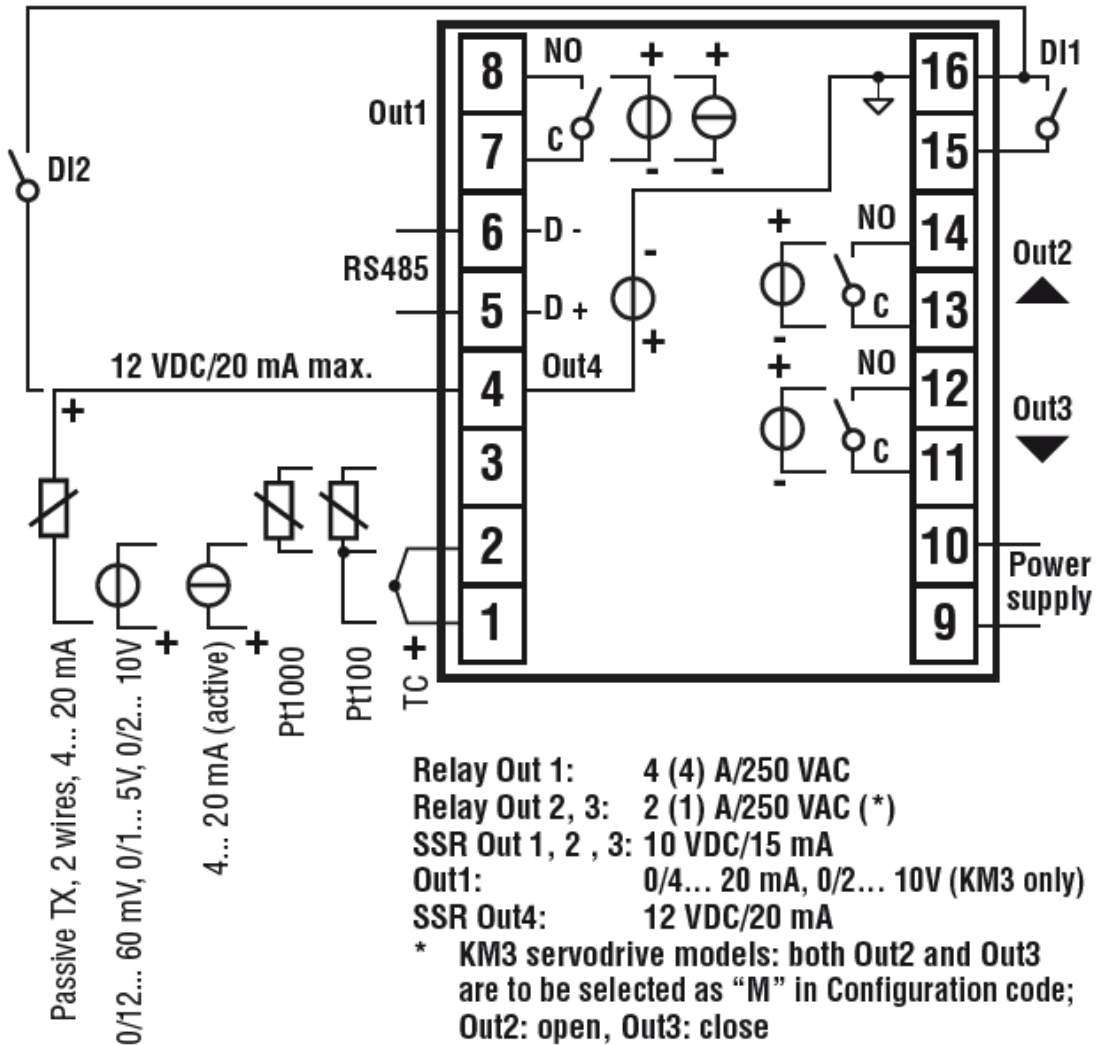

Probe connection:

- **PT1000/NTC/PTC:** between terminal 3 and 2
- **PT 100:** between terminal 3 and 2 with terminal 1
- **Passive pressure probe** 0/4-20 mA: between terminal 4 (+) e 1 (-)
Note: out4 must be activated (IO4F must be setted to ON)
- **Powered pressure probe** 0/4-20 mA between terminal 4 (power supply), 2 (negative) e 1 (positive)
Note: set IO4F to ON to activate Out4

Power supply connection:

- **Neutral wire:** terminal 9
- **Phase:** terminal 10 (100...240 Vac)
- Close terminals 15-16 to switch to the set point 2

Output connection:

- **Channel 1:** terminal 7 and 8 (burner on – off)
- **Channel 2:** terminal 11 and 12 (servomotor opens)
- **Channel 3:** terminal 13 and 14 (servomotor closes)

SETPOINT AND HYSTERESIS CONFIGURATION (SP, AL1, HAL1 parameters)

Push the  button to enter into the setpoint configuration:

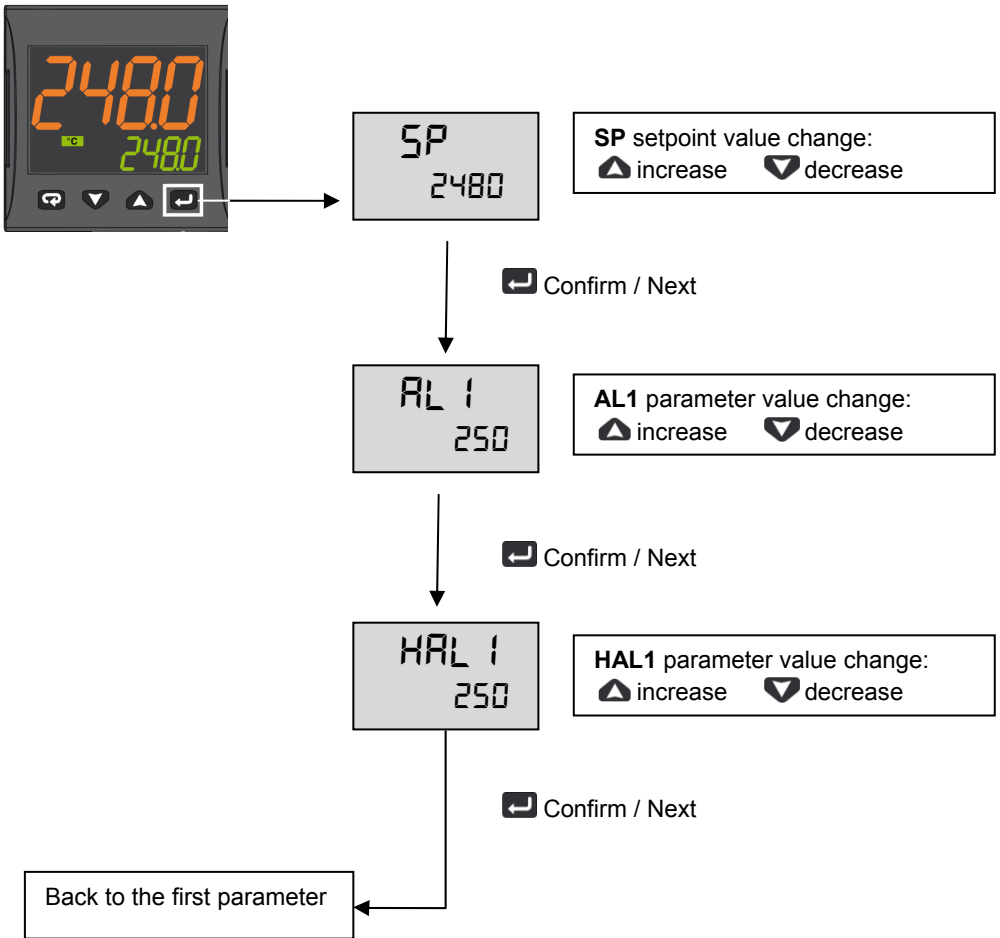

To return to normal mode, press the  key for 3 seconds or wait the 10s timeout

Operation example

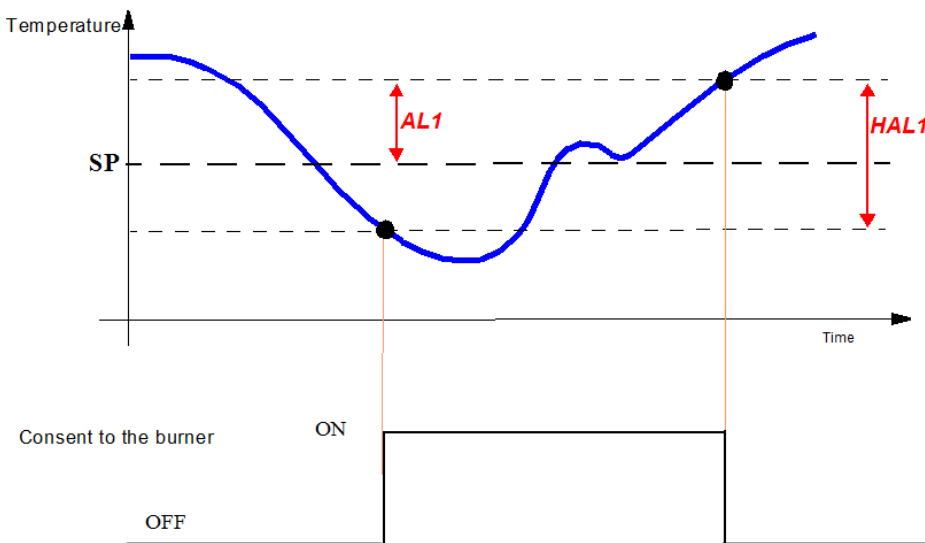

LIMITED ACCESS LEVEL

Proceed as follows to change some parameters that are not visible in standard user mode:

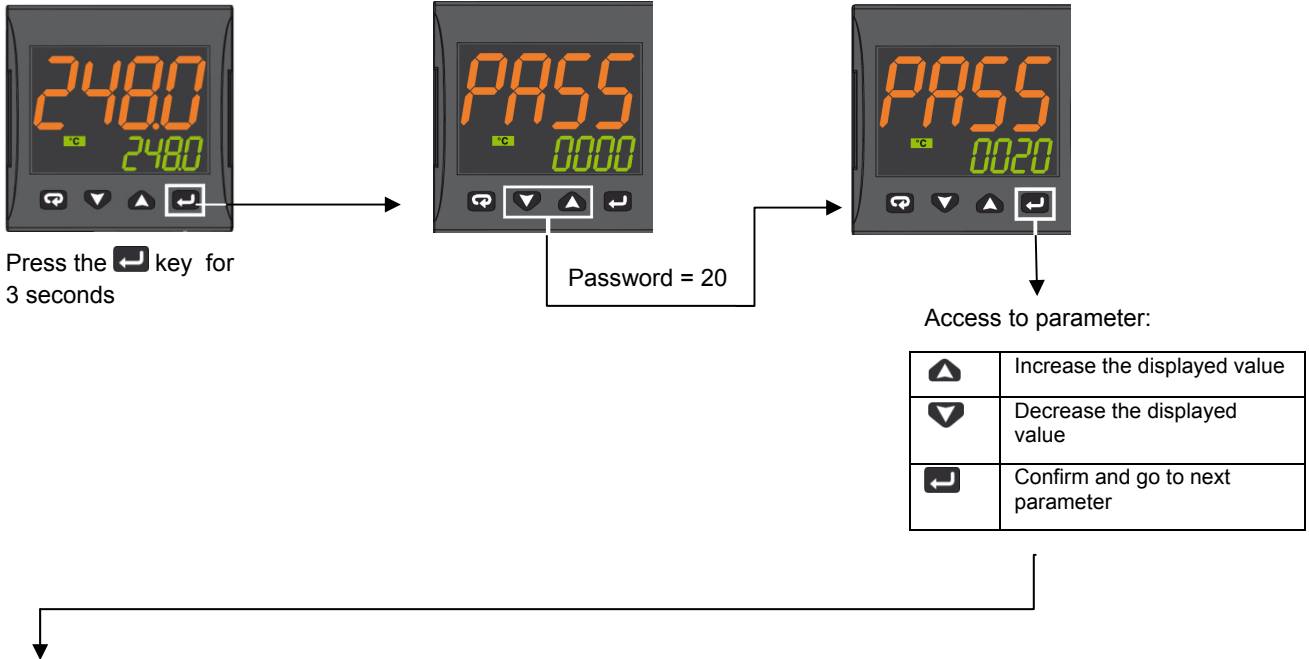

Param	Description	Values	Default
SEnS	Input type	Pt1 = RTD Pt100 Pt10 = RTD Pt1000 0.20 = 0..20mA 4.20 = 4..20mA Pressure probe 0.10 = 0..10V 2.10 = 2..10V crAL= Thermocouple K	Depends on the probe
SP	Set point 1	SPLL ... SPLH	See page 7
AL1	AL1 threshold	AL1L... AL1H (E.U.)	
HAL1	AL1 hysteresis	1... 9999 (E.U.)	
Pb	Proportional band	1... 9999 (E.U.)	
ti	Integral time	0 (oFF) ... 9999 (s)	
td	Derivative time	0 (oFF) ... 9999 (s)	
Str.t	Servomotor stroke time	5...1000 seconds	
db.S	Servomotor dead band	0...100%	
SPLL	Minimum set point value	-1999 ... SPLH	
SPHL	Maximum set point value	SPLL ... 9999	
dp	Decimal point position	0... 3	
SP 2	Set point 2	SPLL...SPLH	60
A.SP	Selection of the active set point	"SP" ... "nSP"	SP

To exit the parameter setting procedure press the key (for 3 s) or wait until the timeout expiration (about 30 seconds)

Probe parameters configuration MODULATORE ASCON KM3

Parameter Group	inP				AL1				rEG				SP			
	Sens	dp	SSC	FSc	unit	IO4.F (**)	AL1 (***)	HAL1 (***)	Pb (***)	ti (***)	td (***)	Str.t	db.S	SPLL	SPHL	SP (***)
Probes		Dec Point	Scale Min	Scale Max			Off	On	p	i	d	servo time s	Band Mo.	SP Min	SP Max	Set point
Pt1000 (130°C max)	Pt10	1			°C	on	5	10	10	350	1	*	5	30	95	80
Pt1000 (350°C max)	PT10	1			°C	on	10	10	10	350	1	*	5	0	350	80
Pt100 (130°C max)	PT1	1			°C	on	5	10	10	350	1	*	5	0	95	80
Pt100 (350°C max)	Pt1	1			°C	on	10	10	10	350	1	*	5	0	350	80
Pt100 (0÷100°C 4÷20mA)	4.20	1	0	100		on	5	10	10	350	1	*	5	0	95	80
Thermocouple K (1200°C max)	crAL	0			°C	on	20	25	10	350	1	*	5	0	1200	80
Thermocouple J (1000°C max)	J	0			°C	on	20	25	10	350	1	*	5	0	1000	80
4-20mA / 0-1,6bar Pressure probe	4.20	0	0	160		on	20	20	5	120	1	*	5	0	160	100
4-20mA / 0-10bar Pressure probe	4.20	0	0	1000		on	50	50	5	120	1	*	5	0	1000	600
4-20mA / 0-16bar Pressure probe	4.20	0	0	1600		on	80	80	5	120	1	*	5	0	1600	600
4-20mA / 0-25bar Pressure probe	4.20	0	0	2500		on	125	125	5	120	1	*	5	0	2500	600
4-20mA / 0-40bar Pressure probe	4.20	0	0	4000		on	200	200	5	120	1	*	5	0	4000	600
QBE2002 / 0-25bar Pressure probe	0.10	0	0	2500		0n	125	125	5	120	1	*	5	0	2500	600

Note:

(*) Str.t - Servomotor stroke time

SQL33; STM30; SQM10; SQM40; SQM50; SQM54 = 30 (Seconds)

STA12B3.41; SQN30.251; SQN72.4A4A20 = 12 (Seconds)

() Out 4 ... on Display led °4 must be switched on, otherwise change the io4.F parameter value from "on" to "out4", confirm the value, quit the configuration mode then change again the io4.F parameter value from "out4" to "on".**







(***) Factory settings. These values must be adapted to machine conditions

N.B. For pressure probe, SP, SPHL, SPLL parameters values are expressed in Kpa (1 bar = 100 Kpa).

CONFIGURATION









How to access configuration level

The configuration parameters are collected in various groups. Every group defines all parameters related with a specific function (e.g.: control, alarms, output functions).

1. Push the  button for more than 5 seconds. The upper display will show PASS while the lower display will show 0.
2. Using  and  buttons set the programmed password.
According to the entered password, it is possible to see a part of the parameters listed in the "configuration parameters" section.
 - a. Enter "30" as password to view all the configuration parameters
 - b. Enter "20" as password to view the parameters of the "limited access level". At this point, only the parameters with attribute **Liv = A** or **Liv = O** will be editable.
 - c. Leave the password blank to edit "user level" parameters, that are identified by attribute **Liv = O**
3. Push the  button. If the password is correct the display will show the acronym of the first parameter group preceded by the symbol: . In other words the upper display will show:  inP (group of the **Input parameters**).

The instrument is in configuration mode. To press  for more than 5 seconds, the instrument will return to the "standard display".

Keyboard functions during parameter changing:

	Operator Mode
	When the upper display is showing a group and the lower display is blank, this key allows to enter in the selected group. When the upper display is showing a parameter and the lower display is showing its value, this key allows to store the selected value for the current parameter and access the next parameter within the same group.
	Allows to increase the value of the selected parameter.
	Allows to decrease the value of the selected parameter.
	Short presses allow you to exit the current group of parameters and select a new group. A long press terminates the configuration procedure (the instrument returns to the normal display).
 + 	These two keys allow to return to the previous group. Proceed as follows: Push the  button and maintaining the pressure, then push the  ; release both the buttons.

Configuration Parameters

inP GROUP - input configuration					
Liv	N°	Param	Description	Values	Default
A	1	SEnS	Input type	Pt1 = RTD Pt100 Pt10 = RTD Pt1000 0.20 = 0..20mA 4.20 = 4..20mA Pressure probe 0.10 = 0..10V 2.10 = 2..10V crAL= Thermocouple K	Depends on the probe
A	2	dp	Decimal point position	0... 3	See page 7
A	3	SSc	Initial scale read-out for linear inputs (available only if SEnS parameter is not equal to Pt1, Pt10, crAL values)	-1999... 9999	0
C	4	FSc	Full scale read-out for linear input inputs (available only if SEnS parameter is not equal to Pt1, Pt10, crAL values)	-1999... 9999	Depends on the probe
C	5	unit	Unit of measure (present only in the case of temperature probe)	°C/°F	°C
C	6	Fil	Digital filter on the measured value	0 (= OFF)... 20.0 s	1.0
C	7	inE	Selection of the Sensor Out of Range type that will enable the safety output value	or = Over range ou = Under range our = over e under range	or

C	8	oPE	Safety output value	-100... 100	0
C	9	io4.F	I/O4 function selection	on = Out4 will be ever ON (used as a transmitter power supply) ,out4 = Uscita 4 (Used as digital output 4), dG2c = Digital input 2 for contact closure, dG2U = Digital input 2 driven by 12... 24 VDC	on
C	10	diF1	Digital input 1 function	oFF = Not used, 1 = Alarm reset, 2 = Alarm acknowledge (ACK), 3 = Hold of the measured value, 4 = Stand by mode, 5 = Manual mode, 6 = HEAt with SP1 and Cool with SP2, 7 = Timer RUN/Hold/Reset, 8 = Timer Run, 9 = Timer Reset, 10 = Timer Run/Hold, 11 = Timer Run/Reset, 12 = Timer Run/Reset with lock, 13 = Program Start, 14 = Program Reset, 15 = Program Hold, 16 = Program Run/Hold, 17 = Program Run/Reset, 18 = Sequential SP selection, 19 = SP1 - SP2 selection, 20 = SP1... SP4 binary selection, 21 = Digital inputs in parallel	19
C	12	di.A	Digital Inputs Action (DI2 only if configured)	0 = DI1 direct action, DI2 direct action 1 = DI1 reverse action, DI2 direct action 2 = DI1 direct action, DI2 reverse action 3 = DI1 reverse action, DI2 reverse action	0

Out GROUP- Output parameters

Liv	N°	Param	Description	Values	Default
C	14	o1F	Out 1 function	AL = Alarm output	AL
C	15	o1AL	Initial scale value of the analog retransmission	-1999 ... Ao1H	1
C	18	o1Ac	Out 1 action	dir = Direct action rEU = Reverse action dir.r = Direct with reversed LED ReU.r = Reverse with reversed LED	rEU.r
C	19	o2F	Out 2 function	H.rEG = Heating output	H.rEG
C	21	o2Ac	Out 2 action	dir = Direct action rEU = Reverse action dir.r = Direct with reversed LED ReU.r = Reverse with reversed LED	dir
C	22	o3F	Out 3 function	H.rEG = Heating output	H.rEG
C	24	o3Ac	Out 3 action	dir = Direct action rEU = Reverse action dir.r = Direct with reversed LED ReU.r = Reverse with reversed LED	dir

AL1 GROUP - Alarm 1 parameters

Liv	N°	Param	Descrizione	Values	Default
C	28	AL1t	Tipo allarme AL1	nonE = Alarm not used LoAb = Absolute low alarm HiAb = Absolute high alarm LHAo = Windows alarm in alarm outside the windows LHAI = Windows alarm in alarm inside the	HidE

				windows SE.br = Sensor Break LodE = Deviation low alarm (relative) HidE = Deviation high alarm (relative) LHdo = Relative band alarm in alarm out of the band LHdi = Relative band alarm in alarm inside the band	
C	29	Ab1	Alarm 1 function	0... 15 +1 = Not active at power up +2 = Latched alarm (manual reset) +4 = Acknowledgeable alarm +8 = Relative alarm not active at set point change	0
C	30	AL1L	-- For High and low alarms, it is the low limit of the AL1 threshold; -- For band alarm, it is low alarm threshold	-1999... AL1H (E.U.)	-199.9
C	31	AL1H	-- For High and low alarms, it is the high limit of the AL1 threshold; -- For band alarm, it is high alarm threshold	AL1L... 9999 (E.U.)	999.9
O	32	AL1	AL1 threshold	AL1L... AL1H (E.U.)	See page 7
O	33	HAL1	AL1 hysteresis	1... 9999 (E.U.)	See page 7
C	34	AL1d	AL1 delay	0 (oFF)... 9999 (s)	oFF
C	35	AL1o	Alarm 1 enabling during Stand-by mode and out of range conditions	0 = Alarm 1 disabled during Stand by and out of range 1 = Alarm 1 enabled in stand by mode 2 = Alarm 1 enabled in out of range condition 3 = Alarm 1 enabled in stand by mode and in overrange condition	1

GRUPPO AL2 - parametri allarme 2

Liv	N°	Param	Description	Values	Default
C	36	AL2t	Alarm 2 type	nonE = Alarm not used LoAb = Absolute low alarm HiAb = Absolute high alarm LHAo = Windows alarm in alarm outside the windows LHAI = Windows alarm in alarm inside the windows SE.br = Sensor Break LodE = Deviation low alarm (relative) HidE = Deviation high alarm (relative) LHdo = Relative band alarm in alarm out of the band LHdi = Relative band alarm in alarm inside the band	SE.br
C	37	Ab2	Alarm 2 function	0... 15 +1 = Not active at power up +2 = Latched alarm (manual reset) +4 = Acknowledgeable alarm +8 = Relative alarm not active at set point change	0
C	42	AL2d	AL2 hysteresis	0 (oFF)... 9999 (s)	oFF
C	43	AL2o	Alarm 2 enabling during Stand-by mode and out of range conditions	0 = Alarm 2 disabled during Stand by and out of range 1 = Alarm 2 enabled in stand by mode 2 = Alarm 2 enabled in out of range condition 3 = Alarm 2 enabled in stand by mode and in overrange condition	0

AL3 Group - alarm 3 parameters					
Liv	N°	Param	Description	Values	Default
	44	AL3t	Alarm 3 type	nonE = Alarm not used LoAb = Absolute low alarm HiAb = Absolute high alarm LHAo = Windows alarm in alarm outside the windows LHAI = Windows alarm in alarm inside the windows SE.br = Sensor Break LodE = Deviation low alarm (relative) HidE = Deviation high alarm (relative) LHdo = Relative band alarm in alarm out of the band LHdi = Relative band alarm in alarm inside the band	nonE

LbA Group - Loop break alarm					
Liv	N°	Param	Descrizione	Values	Default
C	52	LbAt	LBA time	Da 0 (oFF) a 9999 (s)	oFF

rEG Group - Control parameters					
Liv	N°	Param	Description	Values	Default
C	56	cont	Control type	Pid = PID (heat and/or) On.FA = ON/OFF asymmetric hysteresis On.FS = ON/OFF symmetric hysteresis nr = Heat/Cool ON/OFF control with neutral zone 3Pt = Servomotor control (available only when Output 2 and Output 3 have been ordered as "M")	3pt
C	57	Auto	Autotuning selection	-4 = Oscillating auto-tune with automatic restart at power up and after all point change -3 = Oscillating auto-tune with manual start -2 = Oscillating -tune with auto-matic start at the first power up only -1 = Oscillating auto-tune with auto-matic restart at every power up 0 = Not used 1 = Fast auto tuning with automatic restart at every power up 2 = Fast auto-tune with automatic start the first power up only 3 = FAST auto-tune with manual start 4 = FAST auto-tune with automatic restart at power up and after set point change 5 = Evo-tune with automatic restart at every power up 6 = Evo-tune with automatic start the first power up only 7 = Evo-tune with manual start 8 = Evo-tune with automatic restart at power up and after a set point change	7
C	58	tunE	Manual start of the Autotuning	oFF = Not active on = Active	oFF

C	59	SELF	Self tuning enabling	no = The instrument does not perform the self-tuning YES = The instrument is performing the self-tuning	No
A	62	Pb	Proportional band	1... 9999 (E.U.)	See page 7
A	63	ti	Integral time	0 (oFF) ... 9999 (s)	See page 7
A	64	td	Derivative time	0 (oFF) ... 9999 (s)	See page 7
C	65	Fuoc	Fuzzy overshoot control	0.00... 2.00	1
C	69	rS	Manual reset (Integral pre-load)	-100.0... +100.0 (%)	0.0
A	70	Str.t	Servomotor stroke time	5...1000 seconds	See page 7
A	71	db.S	Servomotor dead band	0...100%	5
C	72	od	Delay at power up	0.00 (oFF) ... 99.59 (hh.mm)	oFF

SP Group - Set point parameters

Liv	N°	Param	Description	Values	Default
C	76	nSP	Number of used set points	1... 4	2
A	77	SPLL	Minimum set point value	-1999 ... SPHL	See page 7
A	78	SPHL	Maximum set point value	SPLL ... 9999	See page 7
O	79	SP	Set point 1	SPLL ... SPLH	See page 7
C	80	SP 2	Set point 2	SPLL ... SPLH	60
	83	A.SP	Selection of the active set point	"SP" ... "nSP"	SP
C	84	SP.rt	Remote set point type	RSP = The value coming from serial link is used as remote set point trin = The value will be added to the local set point selected by A.SP and the sum becomes the operative set point PErc = The value will be scaled on the input range and this value will be used as remote SP	trin
C	85	SPLr	Local/remote set point selection	Loc = Local rEn = Remote	Loc
C	86	SP.u	Rate of rise for POSITIVE set point change (ramp UP)	0.01... 99.99 (inF) Eng. units per minute	inF
C	87	SP.d	Rate of rise for NEGATIVE set point change (ramp DOWN)	0.01... 99.99 (inF) Eng. units per minute	inF

PAn Group - Operator HMI

Liv	N°	Param	Description	Values	Default
C	118	PAS2	Level 2 password (limited access level)	oFF (Level 2 not protected by password) 1... 200	20
C	119	PAS3	Level 3 password (complete configuration level)	3... 300	30
C	120	PAS4	Password livello (livello configurazione a codice)	201... 400	300
C	121	uSrb	button function during RUN TIME	nonE = No function tunE = Auto-tune/self-tune enabling. A single press (longer than 1 second) starts the auto-tune oPLo = Manual mode. The first pressure puts the instrument in manual mode (OPLO) while a second one puts the instrument in Auto mode	tunE

				AAC = Alarm reset ASi = Alarm acknowledge chSP = Sequential set point selection St.by = Stand by mode. The first press puts the instrument in stand by mode while a second one puts the instrument in Auto mode. Str.t = Timer run/hold/reset P.run = Program run P.rES = Program reset P.r.H.r = Program run/hold/reset	
C	122	diSP	Display management	Spo = Operative set point	SPO
C	123	di.cL	Display colour	0 = The display colour is used to show the actual deviation (PV - SP) 1 = Display red (fix) 2 = Display green (fix) 3 = Display orange (fix)	2
	125	diS.t	Display Timeout	-- oFF (display always ON) -- 0.1... 99.59 (mm.ss)	oFF
C	126	fiLd	Filter on the displayed value	-- oFF (filter disabled) -- From 0.0 (oFF) to 20.0 (E.U.)	oFF
C	128	dSPu	Instrument status at power ON	AS.Pr = Starts in the same way it was prior to the power down Auto = Starts in Auto mode oP.0 = Starts in manual mode with a power output equal to zero St.bY = Starts in stand-by mode	Auto
C	129	oPr.E	Operative modes enabling	ALL = All modes will be selectable by the next parameter Au.oP = Auto and manual (OPLO) mode only will be selectable by the next parameter Au.Sb = Auto and Stand-by modes only will be selectable by the next parameter	ALL
C	130	oPEr	Operative mode selection	If oPr.E = ALL: - Auto = Auto mode - oPLo = Manual mode - St.bY = Stand by mode If oPr.E = Au.oP: - Auto = Auto mode - oPLo = Manual mode If oPr.E = Au.Sb: - Auto = Auto mode - St.bY = Stand by mode	Auto

SEr Group - Serial link parameter

Liv	N°	Param	Description	Values	Default
C	131	Add	Instrument address	-- oFF -- 1... 254	1
C	132	bAud	baud rate	1200 = 1200 baud 2400 = 2400 baud 9600 = 9600 baud 19.2 = 19200 baud 38.4 = 38400 baud	9600
C	133	trSP	Selection of the value to be retransmitted (Master)	nonE = Retransmission not used (the instrument is a slave) rSP = The instrument becomes a Master and retransmits the operative set point PErc = The instrument become a Master and it retransmits the power output	nonE

con Group - Consumption parameters					
Liv	N°	Param	Description	Values	Default
C	134	Co.tY	Count type	<p>oFF = Not used</p> <p>1 = Instantaneous power (kW)</p> <p>2 = Power consumption (kW/h)</p> <p>3 = Energy used during program execution. This measure starts from zero when a program runs end stops at the end of the program. A new program execution will reset the value</p> <p>4 = Total worked days: number of hours the instrument is turned ON divided by 24.</p> <p>5 = Total worked hours: number of hours the instrument is turned ON.</p> <p>6 = Total worked days with threshold: number of hours the instrument is turned ON divided by 24, the controller is forced in stand-by when Co.ty value reaches the threshold set in [137] h.Job.</p> <p>7 = Total worked hours with threshold: number of hours the instrument is turned ON, the controller is forced in stand-by when Co.ty value reaches the threshold set in [137] h.Job.</p> <p>8 = Totalizer of control relay worked days: number of hours the control relay has been in ON condition, divided by 24.</p> <p>9 = Totalizer of control relay worked hours: number of hours the control relay has been in ON condition.</p> <p>10 = Totalizer of control relay worked days with threshold: number of hours the control relay has been in ON condition divided by 24, the controller is forced in stand-by when Co.ty value reaches the threshold set in [137] h.Job.</p> <p>11 = Totalizer of control relay worked hours with threshold: number of hours the control relay has been in ON condition, the controller is forced in stand-by when Co.ty value reaches the threshold set in [137] h.Job.</p>	oFF
C	138	t.Job	Worked time (not resettable)	0... 9999 days	0

cAL Group - User calibration group					
Liv	N°	Param	Description	Values	Default
C	139	AL.P	Adjust Low Point	From -1999 to (AH.P - 10) in engineering units	0
C	140	AL.o	Adjust Low Offset	-300... +300 (E.U.)	0
C	141	AH.P	Adjust High Point	From (AL.P + 10) to 9999 engineering units	999.9
C	142	AH.o	Adjust High Offset	-300... +300	0

OPERATIVE MODES

When the instrument is powered, it starts immediately to work according to the parameters values loaded in its memory. The instrument behaviour and its performance are governed by the value of the stored parameters.

At power ON the instrument can start in one of the following mode depending on its configuration:

Automatic Mode In Automatic mode the instrument drives automatically the control output according to the parameter value set and the set point/measured value.

Manual Mode (OPLO): In Manual mode the the upper display shows the measured value while the lower display shows the power output The lower display shows the power output [preceded by H (for heating) or C (for cooling)], MAN is lit and the instrument allows you to set manually the control output power. No Automatic action will be made.





Stand by Mode (St.bY): In stand-by mode the instrument operates as an indicator. It will show on the upper display the measured value and on the lower display the set point alternately to the "St.bY" messages and forces the control outputs to zero.

We define all the above described conditions as "Standard Display".

As we have seen, it is always possible to modify the value assigned to a parameter independently from the operative modes selected.









AUTOMATIC MODE

Keyboard function when the instrument is in Auto mode:

Modo Operatore	
	Allows entry into parameter modification procedures
	Allows you to start the "Direct set point modification" function (see below).
	Allows you to display the "additional informations" (see below).
	Performs the action programmed by [121] uSrb ( button function during RUN TIME) parameter

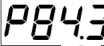
Additional information





This instrument is able to show you some additional informations that can help you to manage your system. The additional informations are related to how the instrument is programmed, hence in many cases, only part of this information is available.

1. When the instrument is showing the "standard display" push  button. The lower display will show H or c followed by a number. This value is the current power output applied to the process. The H show you that the action is a Heating action while the "c" show you that the action is a Cooling action
2. Push  button again. When the programmer is running the lower display will show the segment currently performed and the Event status as shown below:
 where the first character can be r for a ramp or S for a soak, the next digit show the number of the segment (e.g. S3 means Soak number 3) and the twoless significant digits (LSD) show you the status of the two event (the LSD is the Event 2)..
3. Push  button again. When the programmer is running the lower display will show the theoretical remaining time to the end of the program preceded by a "P" letter:

4. Push  button again. When the wattmeter function is running the lower display will show U followed by the measured energy..
5. Push  button. When the "Worked time count" is running the lower display will show "d" for days or "h" for hours followed by the measured time.
6. Push  button. The instrument returns to the "standard display".



Note: The additional information visualization is subject to a time out. If no button is pressed for more than 10 second the instrument comes automatically back to the Standard display..

Direct set point modification

This function allows to modify rapidly the set point value selected by [83] A.SP (selection of the active Set point) or to the set point of the segment group (of the programmer) currently in progress.

1. Push  button. The upper display shows the acronym of the selected set point (e.g. SP2) and the lower display will show its value.
2. By  and  buttons, assign to this parameter the desired value
3. Do not push any button for more than 5 second or push the  button. In both cases the instrument memorize the new value and come back to the “standard display”.

Manual mode

This operative mode allows you to deactivate automatic control and manually program the percentage power output to the process. When the instrument is in manual mode, the upper display shows the measured value while the lower display shows the power output [preceded by H (for heating action) or C (for cooling action)] The MAN LED is lit. When manual control is selected, the instrument will start to operate with the same power output as the last one supplied by automatic mode and can be modified using the  and  buttons.

In case of ON/OFF control, 0% corresponds to the deactivated output while any value different from 0 corresponds to the activated output. As in the case of visualization, the programmable values range from H100 (100% output power with reverse action) to C100 (100% output power with direct action).

Notes:

- During manual mode, the alarms are operative.
- If you set manual modes during program execution, the program will be frozen and it will restart when the instrument will come back to Auto mode.
- If you set manual modes during self-tune execution, the self- tune function will be aborted.
- During manual mode, all functions not related with the control (wattmeter, independent timer, “worked time”, etc) continue to operate normally..

STAND-BY MODE

This operative mode also deactivates the automatic control but forces the control output to zero. In this mode the instrument operates as an indicator. When the instrument is in stand by mode the upper display will show the measured value while the lower display will show alternately the set point and the message “St.bY”.

Notes:

- During stand by mode, the relative alarms are disabled while the absolute alarms are operative or not according to the ALx0 (Alarm x enabling during Stand-by mode) parameter setting.
- If you set stand by mode during program execution, the program will be aborted.
- If you set stand by mode during self-tune execution, the self- tune function will be aborted.
- During stand by mode, all functions not related with the control (wattmeter, independent timer, “worked time”, etc) continue to operate normally.
- When the instrument is swapped from stand by to auto modes, the instrument will start automatically the alarm masking, the soft start functions and the auto-tune (if programmed).

AUTOTUNE (EVOTUNE)

Evotune is a fast and fully automatic procedure that can be started in any condition, regardless the deviation from SP. The controller selects automatically the best tune method and computes the optimum PID parameters. To activate Evotune press  button for 3 seconds.

ERROR MESSAGES

The upper display shows the OVER-RANGE and UNDERRANGE conditions with the following indications:

Over-range: 

Under-range 

The sensor break will be signalled as an out of range: - - - -

Note: When an over-range or an under-range is detected, the alarms operate as in presence of the maximum or the minimum measurable value respectively.

To check the out of span Error condition, proceed as follows:

1. Check the input signal source and the connecting line.
2. Make sure that the input signal is in accordance with the instrument configuration. Otherwise, modify the input configuration.
3. If no error is detected, send the instrument to your supplier to be checked.

List of possible errors

ErAT Fast Auto-tune cannot start. The measure value is too close to the set point. Push the button in order to delete the error message.

ouLd Overload on the out 4. The messages shows that a short circuit is present on the Out 4 when it is used as output or as a transmitter power supply. When the short circuit disappears the output restart to operate..

NoAt Auto-tune not finished within 12 hours.

ErEP Possible problem of the instrument memory. The messages disappears automatically. When the error continues, send the instrument to your supplier.





RonE Possible problem of the firmware memory. When this error is detected, send the instrument to your supplier.

Errt Possible problem of the calibration memory. When this error is detected, send the instrument to your supplier.

FACTORY RESET

Sometime, e.g. when you re-configure an instrument previously used for other works or from other people or when you have made too many errors during configuration and you decided to re-configure the instrument, it is possible to restore the factory configuration. This action allows to put the instrument in a defined condition (the same it was at the first power ON).

The default data are those typical values loaded in the instrument prior to ship it from factory. To load the factory default parameter set, proceed as follows:

1. Press the  button for more than 5 seconds. The upper display will show PASS while the lower display shows 0;
2. Using  and  buttons set the value -481;
3. Push  button;
4. The instrument will turn OFF all LEDs for a few seconds, then the upper display will show dFLt (default) and then all LEDs are turned ON for 2 seconds. At this point the instrument restarts as for a new power ON.

The procedure is complete.

Note: The complete list of the default parameters is available in Chapter "Configuration".

RWF55.5X & RWF55.6X



User manual

DEVICE INSTALLATION

Fixing system

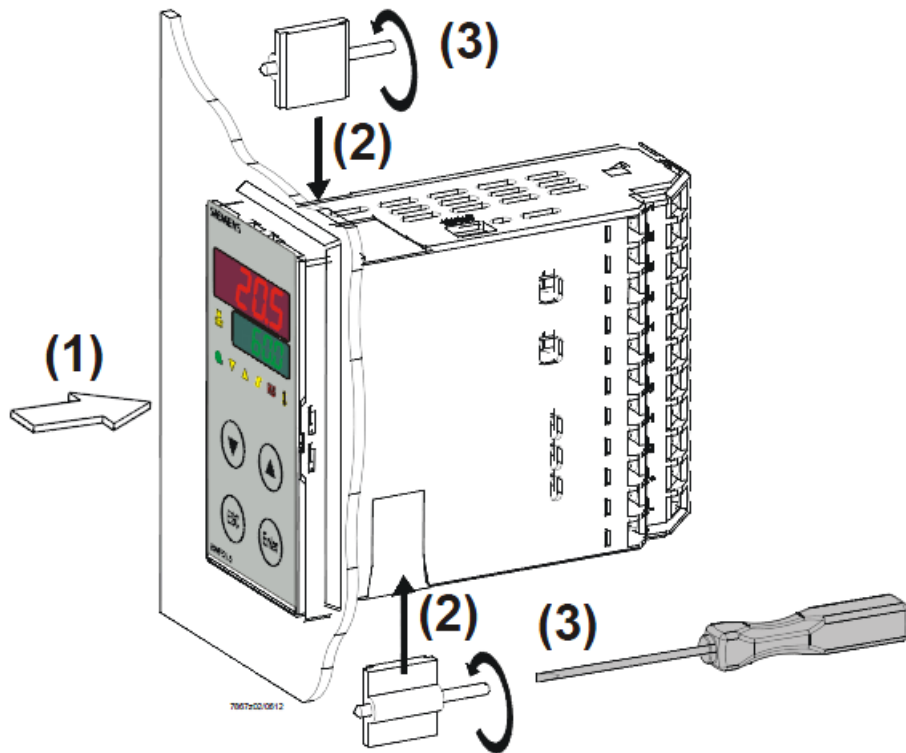

Drilling dimensions:

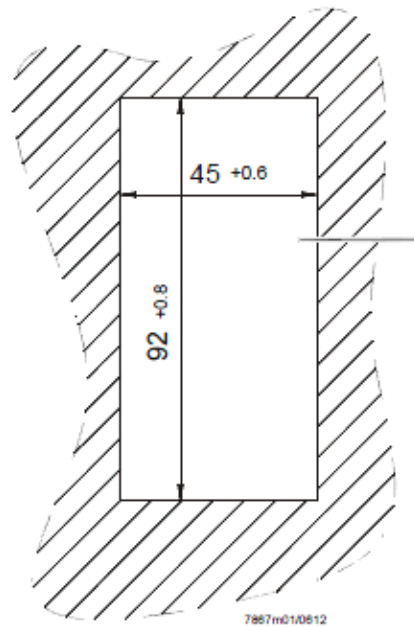

FRONT PANEL

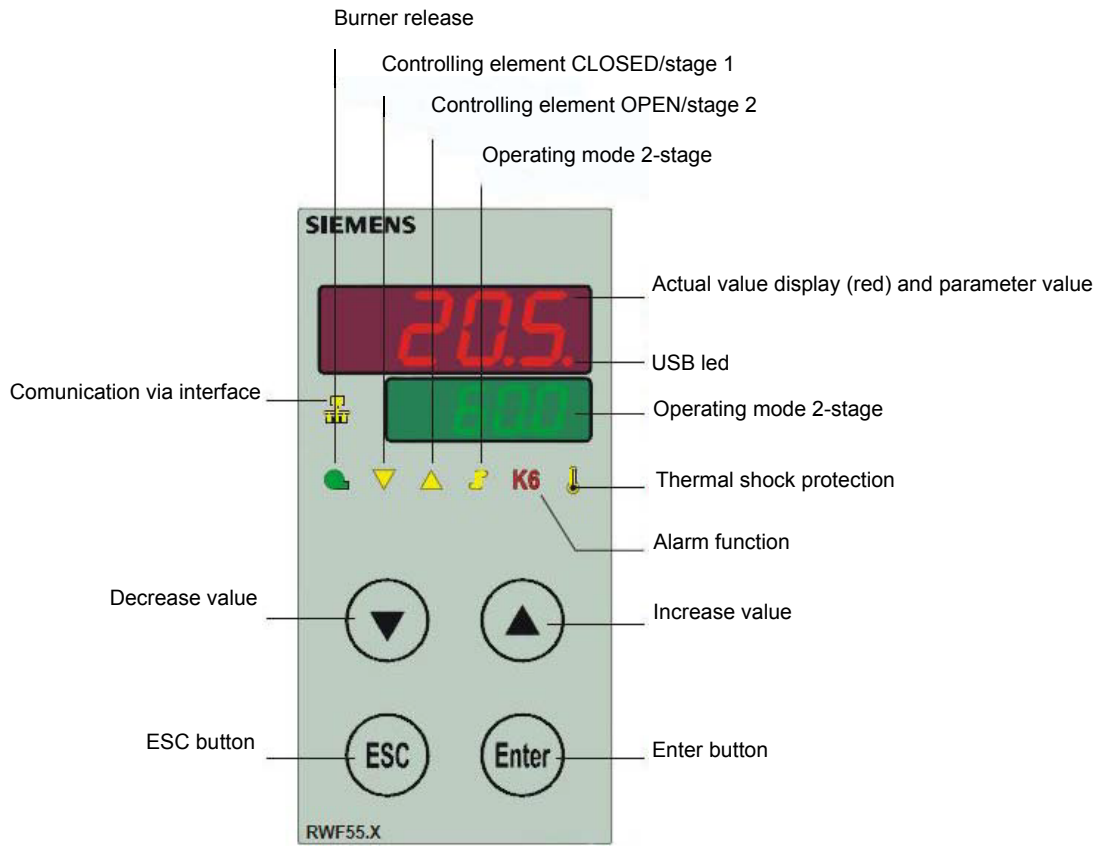

NAVIGATION MENU

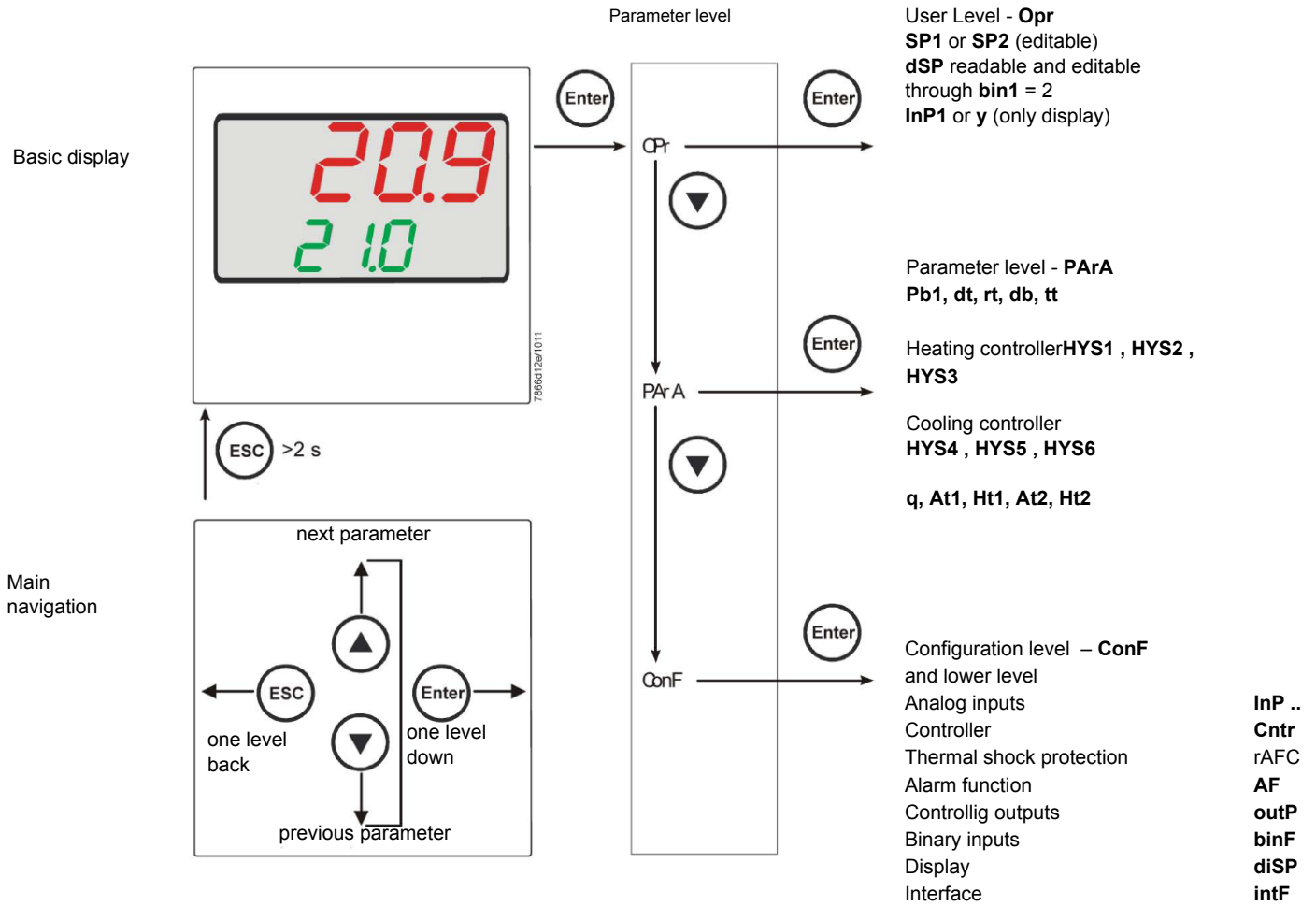

RWF55 is preset good for 90% of applications. However, you can set or edit parameters as follow:

Set-point: set or modification:

When the burner is in stand-by, (safety loop open, that is terminals 3-4/T1-T2 on the 7 pole plug open) push the Enter button: on the lower display (green) Opr appears; push Enter again and in the same display SP1 appears. Push Enter again and the lower display (green SP1) flashes. Using the up and down arrows change the set-point on the upper display (red).Push Enter to confirm and push ESC more times to get the home position.

PID parameters set and modifications (PARA):

Push **Enter** button, on the green display **Opr** appears; using the **down arrow**, scroll until group **PARA** is reached and push **Enter**.
On the green display **Pb1** e appears and on the red one the set parameter. Push is sequence the **down or up** arrow the menu is scrolled.
Push **Enter** to select and the **arrows** to choose the desired value. **Enter** to confirm

Parameter	Display	Range	Factory setting	Remarks
Proportional band	Pb1	1... 9999 digit	10	Typical value for temperature
Derivative action	dt	0... 9999 sec.	80	Typical value for temperature
Integral action	rt	0... 9999 sec.	350	Typical value for temperature T
Dead band (*)	db	0... 999,9 digit	1	Typical value
Servocontrol running time	tt	10... 3000 sec.	15	Set servocontrol running time
Switch-on differential (*)	HYS1	0,0... -1999 digit	-5	Value under setpoint below which the burner switches back on (1N-1P closes)
Switch-off differential 2° stage (*)	HYS2	0,0 ... HYS3	3	(enable only with parameter bin1 = 4)
Upper switch-off differential (*)	HYS3	0,0... 9999 digit	5	Value over setpoint above which the burner switches off (1N-1P opens)
Switch-on differential on cooling controller (*)	HYS4	0,0... 9999 digit	5	Do not used (enable only with parameter CACT = 0)
Switch-off differential 2° stage on cooling controller (*)	HYS5	HYS6...0,0 digit	5	Do not used (enable only with parameter CACT = 0 and parameter bin1 =0)
Upper switch-off differential on cooling controller (*)	HYS6	0,0... -1999 digit	5	Do not used (enable only with parameter CACT = 0)
Delay modulation	q	0,0... 999,9 digit	0	Do not alter
T Outside temperature Curve point 1 (*)	At1	-40 ...120 digit	-10	First point of external temperature for climatic curve
Boiler temperature Curve point 1 (*)	Ht1	SPL...SPH	60	Set-point temperature for the external temperature 1
TT Outside temperature Curve point 2 (*)	At2	-40 ...120 digit	20	Second point of external temperature for climatic curve
Boiler temperature Curve point 2 (*)	Ht2	SPL...SPH	50	Set-point temperature for the external temperature 2

(*) Parameters affected by setting of decimal place (**ConF** > **dISP** parameter **dECP**)

Setting the kind of sensor to be connected to the device:

Push the **Enter** button: on the lower display (green) **Opr** appears. Using the **up and down arrows** find **ConF**. Push **Enter** to confirm. Now on the green display the group **InP** appears. Push **Enter** and **InP1** is displayed. Enter to confirm. You are inside **InP1**; the green display shows **Sen1 (sensor type)**, while the red display shows the chosen sensor code Push **Enter** to enter the **Sen1** parameter, then choose the desired sensor using the **arrows**. Push **Enter** to confirm and **ESC** to escape.

Once selected the sensor, you can modify all the other parameters using **up and down arrows** according to the tables here below :

ConF > InP > InP1

Parameter	Value	Description
SEn1 type of sensor for analog input 1	1	Pt100 3 wire
	2	Pt100 2 wire
	3	Pt1000 3 wire
	4	Pt1000 2 wire
	5	Ni1000 3 wire
	6	Ni1000 2 wire
	7	0 ÷ 135 ohm
	8	Cu-CuNi T
	9	Fe-CuNi J
	10	NiCr-Ni K
	11	NiCrSi-NiSi N
	12	Pt10Rh-Pt S
	13	Pt13Rh-Pt R
	14	Pt30Rh-Pt6Rh B
	15	0 ÷ 20mA
	16	4 ÷ 20mA
	17	0 ÷ 10V
	18	0 ÷ 5V
	19	1 ÷ 5V
OFF1 Sensor offset	-1999..0.. +9999	Correction value measured by the sensor
SCL1 scale low level	-1999..0.. +9999	minimum scale value(for input ohm, mA, V)
SCH1 scale high level	-1999.. 100 .. +9999	maximum scale value(for input ohm, mA, V)
dF1 digital filter	0... 0,6 ...100	Is used to adapt the digital 2nd order input filter (time in s; 0 s = filter off)
Unit temperature unit	1	1 = degrees Celsius
	2	2 = degrees Fahrenheit

(**bold** = factory settings)

ConF > InP > InP2

Input 2 : this input can be used to specify an external setpoint or carry out setpoint shifting

Parameter	Value	Description
FnC2	0	0= no function
	1	1= external setpoint (display SPE)
	2	2 =setpoint shifting (display dSP)
	3	3 = angular positioning feedback
SEn2 sensor type input 2	1	0 ÷ 20mA
	2	4 ÷ 20mA
	3	0 ÷ 10V
	4	0 ÷ 5V
	5	1 ÷ 5V
	1	0 ÷ 20mA
OFF2 Sensor offset	-1999..0.. +9999	Correction value measured by the sensor
SCL2 scale low level	-1999..0.. +9999	minimum scale value(for input ohm, mA, V)
SCH2 scale high level	-1999.. 100 .. +9999	maximum scale value(for input ohm, mA, V)
dF2 digital filter	0... 2 ...100	Is used to adapt the digital 2nd order input filter (time in s; 0 s = filter off)

(**bold** = factory settings)

ConF > InP > InP3

Input 3: this input is used to acquire the outside temperature

Parameter	Value	Description
SEn3 sensor type input 3 sensor type input 2	0	0 =
	1	1 = wire
	2	2 = wire
OFF3 Sensor offset	-1999..0.. +9999	Correction value measured by the sensor
dF3 digital filter	0... 1278 ...1500	Is used to adapt the digital 2nd order input filter (time in s; 0 s = filter off)

(**bold** = factory settings)

ConF > Cntr

Here, the type of controller, operating action, setpoint limits and presettings for self-optimization are selected

Parameter	Value	Description
CtYP controller type	1 2	1 = 3-position controller (open-stop-close) 2 = continuative action controller (0 ÷ 10V or 4 ÷ 20mA)
CACT control action	1 0	1 = heating controller 0 = cooling controller
SPL least value of the set-point range	-1999.. 0 ..+9999	minimum set-point scale
SPH maximum value of the set-point range	-1999.. 100 ..+999	maximum set-point scale
Self-optimization	0 1	0 = Free 1 = Locked Self-optimization can only be disabled or enabled via the ACS411 setup program. Self-optimization is also disabled when the parameter level is locked
oLLo set-point limitation start, operation limit low	- 1999 +9999	lower working range limit
oLHi set-point limitation end, operation limit high	-1999.... +9999	upper working range limit

(**bold** = factory settings)

ConF > rAFC

Activation boiler shock termic protetion:

RWF55.. can activate the thermal shock protection only on sites where the set-point is lower than 250°C and according to **rAL** parameter

Parameter	Value	Description
FnCT type of contol	0 1 2	choose type of range degrees/time 0 = deactivated 1 = Kelvin degrees/minute 2 = Kelvin degrees/hour
rASL ramp rate	0,0 ... 999,9	Slope of thermal shock protection (only with functions 1 and 2)
toLP tolerance band ramp	2 x (HYS1) = 10 ...9999	width of tolerance band (in K) about the set-point 0 = tolerance band inactive
rAL ramp limit	0 ...250	Ramp limit. When this value is lower than the temperature set-point, the RWF controls the output increasing the temp set point step by step according to rASL . If this is over the temp set point, the control is performed in cooling

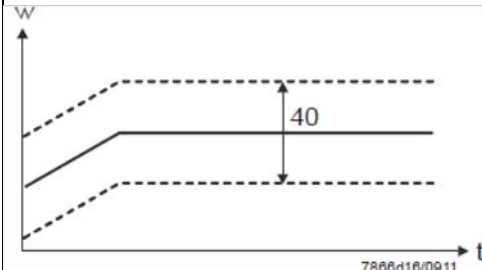

(**bold** = factory settings)

Alarm function AF

The alarm function can be used to monitor the analog inputs. If the limit value is exceeded, multifunctional relay K6 (terminals **6N** and **6P**) is activated (depending on the switching characteristic)

The alarm function can have different switching functions (Ik1 to Ik8) and can be set to a deviation from the active setpoint or to a fixed limit value

Limit value **AL** relative to setpoint (x)

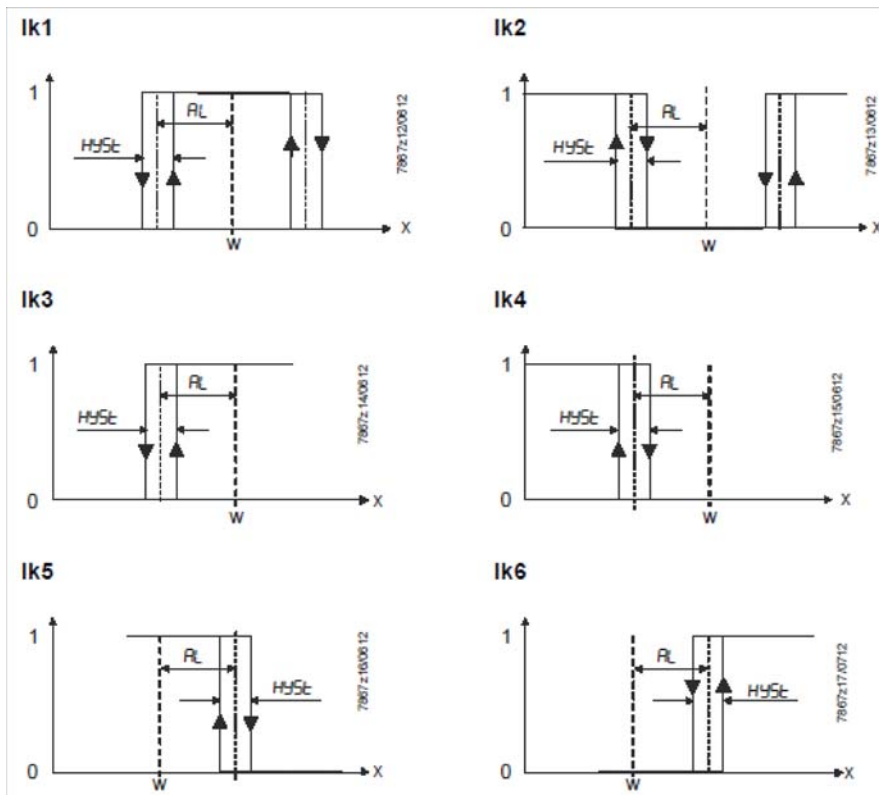

Fixed limit value **AL**

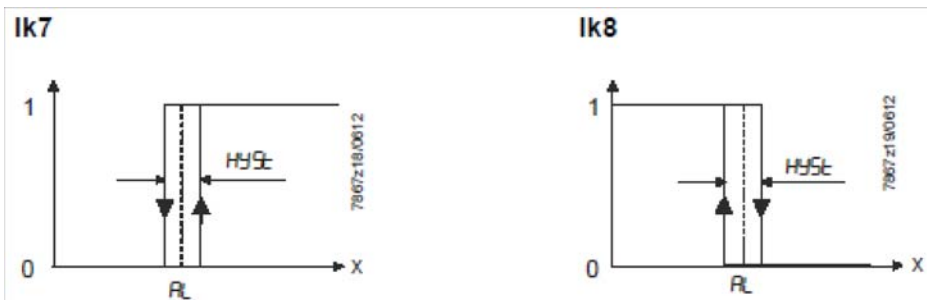

ConF > AF

Parameter	Value	Description
FnCt type of control	0 1 2 3 4 5 6 7 8 9 10 11 12	0 = Without function lk1 = monitored input InP1 lk2 = monitored input InP1 lk3 = monitored input InP1 lk4 = monitored input InP1 lk5 = monitored input InP1 lk6 = monitored input InP1 lk7 = monitored input InP1 lk8 = monitored input InP1 lk7 = monitored input InP2 lk8 = monitored input InP2 lk7 = monitored input InP3 lk8 = monitored input InP3
Alarm value AL	-1999 ... 0 1999	Limit value or deviation from setpoint to be monitored (see alarm functions lk1 to lk8 : limit value AL) Limit value range for lk1 and lk20 ...9999
HySt switching differential	0... 1... 9999	Switching differential for limit value AL
ACrA response by out of range	0 1	Switched-off ON Switching state in the case of measuring range overshoot or undershoot (Out of Range)

(**bold** = factory settings)

ConF > OutP

For fuel-air ratio control purposes, the RWF55 has the binary outputs K2, K3 (terminals KQ, K2, K3) and the analog output (terminals A+, A-). The burner is released via relay K1 (terminals 1N, 1P) .

The binary outputs of the RWF55 offer no setting choices

The RWF55 has an analog output.

The analog output offers the following setting choices:

Parameter	Value	Description
FnCt type of control	1 2 3 4	1 = analog input 1 doubling with possibility to convert 2 = analog input 2 doubling with possibility to convert 3 = analog input 3 doubling with possibility to convert 4 = Controller's angular positioning is delivered (modulating controller)
SiGn type of output signal	0 1 2	physical output signal (terminals A+, A-) 0 = 0÷20mA 1 = 4÷20mA 2 = 0÷10V DC
rOut value when out of input range	0 ...101	signal (in percent) when measurement range is crossed
oPnt zero point	-1999... 0 ...+9999	A value range of the output variable is assigned to a physical output signal (for FnCt = 1, 2, 3)
End end point	-1999... 100 ...+9999	A value range of the output variable is assigned to a physical output signal (for FnCt = 1, 2, 3)

(**bold** = factory settings)

ConF > binF

This setting decides on the use of the binary inputs **D1**, **D2**, **DG**

b

Parameter	Value	Description
bin1 binary input 1 (terminals DG – D1)	0 1 2 3	0 = without function 1 = set-point changeover (SP1 / SP2) 2 = Iset-point shift (Opr > dSP parameter = value of set-point modify) 3 = input alarm
bin2 binary input 2 (terminals DG – D2)	4	changeover of operating mode DG-D2 open = modulating operation DG-D2 close = 2 stage operation

(**bold** = factory settings)

ConF > dISP

.Both displays can be customized to suit your needs by configuring the displayed value, decimal, time out and blocking

Parameter	Value	Description
diSU upper display (red)	0 1 2 3 4 6 7	Display value for upper display: 0 = display power-off 1 = analog input 1 (InP1) value 2 = analog input 2 (InP2) value 3 = analog input 3 (InP3) value 4 = controller's angular positioning 6 = set-point values 7 = end value with thermal shock protection
diSL lower display (green)	0 1 2 3 4 6 7	Display value for lower display: 0 = display power-off 1 = analog input 2 (InP2) value 2 = analog input 2 (InP2) value 3 = analog input 2 (InP2) value 4 = controller's angular positioning 6 = set-point values 7 = end value with thermal shock protection
tout timeout	0.. 180 ..250	time (s) on completion of which the controller returns automatically to the basic display, if no button is pressed
dECP decimal point	0 1 2	0 = no decimal place 1 = one decimal place 2 = two decimal place
CodE level lockout	0 1 2 3	0 = no lockout 1 = configuration level lockout (ConF) 2 = parameter and configuration level lockout (PARa & ConF) 3 = keyboard lockout

(**bold** = factory settings)

ConF > IntF

The controller can be integrated into a data network using an optional RS-485 (terminals R+ and R-) interface or an optional Profibus DP interface(only model **RWF55.6x** terminals C1-C2-C3-C4)

Parameter	Value	Description
bdrt	0	0 = 4800 baud
baudrate	1	1 = 9600 baud
	2	2 = 19200 baud
	3	3 = 38400 baud
Adr	0..	Address in the data network
Device address Modbus	1..	
	254	
dP	0.. 125	only with RWF55.6x
Device address Profibus		
dt	0..	0 = switched-off
Remote detection time	30 ..	
	7200s	

(**bold** = factory settings)

Manual control :

In order to manual change the burner load, while firing keep pushing the **ESC** button for more than 5 s; on the lower green display **Hand** appears.

using the **UP** and **DOWN** arrows, the load varies.

Keep pushing the **ESC** button for getting the normal operation again.

NB: every time the device shuts the burner down (start led switched off - contact 1N-1P open), the manual control is not active.

Device self-setting (auto-tuning):

If the burner in the steady state does not respond properly to heat generator requests, you can activate the Device's self-setting function, which recalculates PID values for its operation, deciding which are most suitable for the specific kind of request



Follow the below instructions:

push the **UP** and **DOWN** arrows for more than 5 s; on the green lower display **tUnE** appears. Now the device pushes the burner to increase and decrease its output. During this time, the device calculates **PID** parameters (**Pb1**, **dt** and **rt**). After the calculations, the **tUnE** is automatically deactivated and the device has already stored them.

In order to stop the Auto-tuning function while it works, push again the **UP** and **DOWN** arrows for more than 5 s. The calculated **PID** parameters can be manually modified following the previously described instructions.

Display of software version :

The software version is shown by pushing Enter + UP arrow on the upper display.



Weather-compensated setpoint shifting (climatic regulation):

The RWF55 can be configured so that weather-compensated setpoint shifting is activated when an LG-Ni1000 outside sensor or a Pt1000 is connected (see parameter **InP3**).

To take into account the time response of a building, weather-compensated setpoint shifting uses the attenuated outside temperature rather than the current outside temperature.

The minimum and maximum setpoints can be set using the lower setpoint limit **SPL** and the upper setpoint limit **SPH** of the menu **Crtr**.

The system also prevents the lower working range limit **oLLo** and upper working range limit **oLHi** from exceeding/dropping below the system temperature limits.

The heating curve describes the relationship between the boiler temperature setpoint and the outside temperature. It is defined by 2 curve points. For 2 outside temperatures, the user defines the boiler temperature setpoint that is required in each case. The heating curve for the weather-compensated setpoint is calculated on this basis. The effective boiler temperature setpoint is limited by the upper setpoint limit **SPH** and the lower setpoint limit **SPL**.

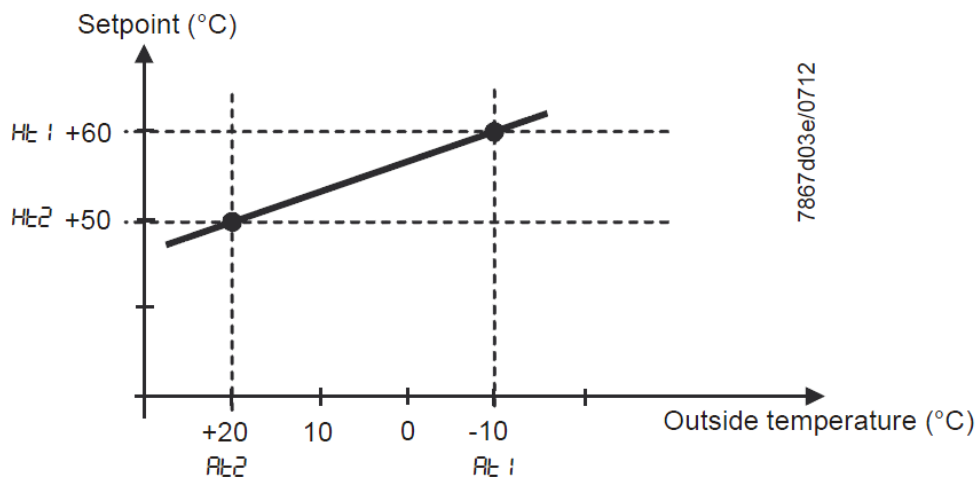

For setting climatic regulation function set:

PArA > parameters **At1**, **Ht1**, **At2**, **Ht2**

ConF > **InP** > **InP3** parameters **SEn3**, **FnC3** = 1 (Weather-compensated setpoint).

Modbus interface

The tables that follow in this chapter specify the addresses of the readable and writable words that the customer is able to access. The customer may read and/or write the values using SCADA programs, PLCs, or similar.

The entries under Access have the following meanings:

R/O Read Only, value can only be read

R/W Read/Write, value can be read and written

The number of characters specified under Data type in the case of character strings includes the final \0.

Char10 means that the text is up to 9 characters long. The final \0 character is then added to this

User level

Address	Access	Data type	Signal reference	Parameter
0x0000	R/O	Float	X1	Analog input InP1
0x0002	R/O	Float	X2	Analog input InP2
0x0004	R/O	Float	X3	Analog input InP2
0x0006	R/O	Float	WR	Actual setpoint
0x0008	R/W	Float	SP1	Setpoint 1
0x000A	R/W	Float	SP2 (= dSP)	Setpoint 2
0x1035	R/O	Float	---	Analog input InP3 (unfiltered)
0x1043	R/O	Float	---	Actual angular positioning
0x1058	R/O	Word	B1	Burner alarm

Parameter level

Address	Access	Data type	Signal reference	Parameter
0x3000	R/W	Float	Pb1	Proportional range 1
0x3004	R/W	Float	dt	Derivative action time
0x3006	R/W	Float	rt	Integral action time
0x300C	R/W	Float	db	Dead band
0x3012	R/W	Word	tt	Controlling element running time
0x3016	R/W	Float	HYS1	Switch-on threshold
0x3018	R/W	Float	HYS2	Switch-off threshold down
0x301A	R/W	Float	HYS3	Switch-off threshold up
0x301C	R/W	Float	HYS4	Switch-on threshold (cooling)
0x301E	R/W	Float	HYS5	Switch-off threshold down (cooling)
0x3020	R/W	Float	HYS6	Switch-off threshold up (cooling)
0x3022	R/W	Float	q	Reaction threshold
0x3080	R/W	Float	At1	Outside temperature 1
0x3082	R/W	Float	Ht2	Boiler temperature 1
0x3084	R/W	Float	At2	Outside temperature 2
0x3086	R/W	Float	Ht2	Boiler temperature 2

Configuration level

Address	Access	Data type	Signal reference	Parameter
0x3426	R/W	Float	SCL1	Start of display input 1
0x3428	R/W	Float	SCH1	End of display input 1
0x3432	R/W	Float	SCL2	Start value input 2
0x3434	R/W	Float	SCH2	End value input 2
0x3486	R/W	Float	SPL	Start of setpoint limitation
0x3488	R/W	Float	SPH	End of setpoint limitation
0x342A	R/W	Float	OFFS1	Offset input E1
0x3436	R/W	Float	OFFS2	Offset input E2
0x343A	R/W	Float	OFFS3	Offset input E3
0x1063	R/W	Word	FnCt	Ramp function
0x1065	R/W	Float	rASL	Ramp slope
0x1067	R/W	Float	toLP	Tolerance band ramp
0x1069	R/W	Float	rAL	Limit value
0x1075	R/W	Float	dtT	Remote Detection Timer
0x1077	R/W	Float	dF1	Filter constant input 1
0x1079	R/W	Float	dF2	Filter constant input 2
0x107B	R/W	Float	dF3	Filter constant input 3
0x107D	R/O	Float	oLLo	Lower working range limit
0x107F	R/O	Float	oLHi	Upper working range limit
0x106D	R/W	Word	FnCt	Alarm relay function
0x106F	R/W	Float	AL	Alarm relay limit value (limit value alarm)
0x1071	R/W	Float	HYSt	Alarm relay hysteresis

Remote operation

Address	Access	Data type	Signal reference	Parameter
0x0500	R/W	Word	REM	Activation remote operation *
0x0501	R/W	Word	rOFF	Controller OFF in remote setpoint **
0x0502	R/W	Float	rHYS1	Switch-on threshold remote
0x0504	R/W	Float	rHYS2	Switch-off threshold down remote
0x0506	R/W	Float	rHYS3	Switch-off threshold up remote
0x0508	R/W	Float	SPr	Setpoint remote
0x050A	R/W	Word	RK1	Burner release remote operation
0x050B	R/W	Word	RK2	Relay K2 remote operation
0x050C	R/W	Word	RK3	Relay K3 remote operation
0x050D	R/W	Word	RK6	Relay K6 remote operation
0x050E	R/W	Word	rStEP	Step-by-step control remote operation
0x050F	R/W	Float	rY	Angular positioning output remote operation
0x0511	R/W	Float	rHYS4	Switch-on threshold remote (cooling)
0x0513	R/W	Float	rHYS5	Switch-off threshold down remote (cooling)
0x0515	R/W	Float	rHYS6	Switch-off threshold up remote (cooling)

Legend

* = Local

** = Controller OFF

Dati dell'apparecchio

Address	Access	Data type	Signal reference	Parameter
0x8000	R/O	Char12	---	Software version
0x8006	R/O	Char14	---	VdN number

Stato dell'apparecchio

Address	Access	Data type	Signal reference	Parameter
0x0200	R/O	Word	---	Outputs and states
			Bit 0	Output 1
			Bit 1	Output 3
			Bit 2	Output 2
			Bit 3	Output 4
			Bit 8	Hysteresis limitation
			Bit 9	Control system
			Bit 10	Self-optimization
			Bit 11	Second setpoint
			Bit 12	Measuring range overshoot InP1
			Bit 13	Measuring range overshoot InP2
			Bit 14	Measuring range overshoot InP3
			Bit 15	Calibration mode
0x0201	R/O	Word	---	Binary signals and hardware detection
			Bit 0	Operation mode 2-stage
			Bit 1	Manual mode
			Bit 2	Binary input D1
			Bit 3	Binary input D2
			Bit 4	Thermostat function
			Bit 5	First controller output
			Bit 6	Second controller output
			Bit 7	Alarm relay
			Bit 13	Analog output available
			Bit 14	Interface available

Electric connections :

With 7 pins connector version

With terminals version

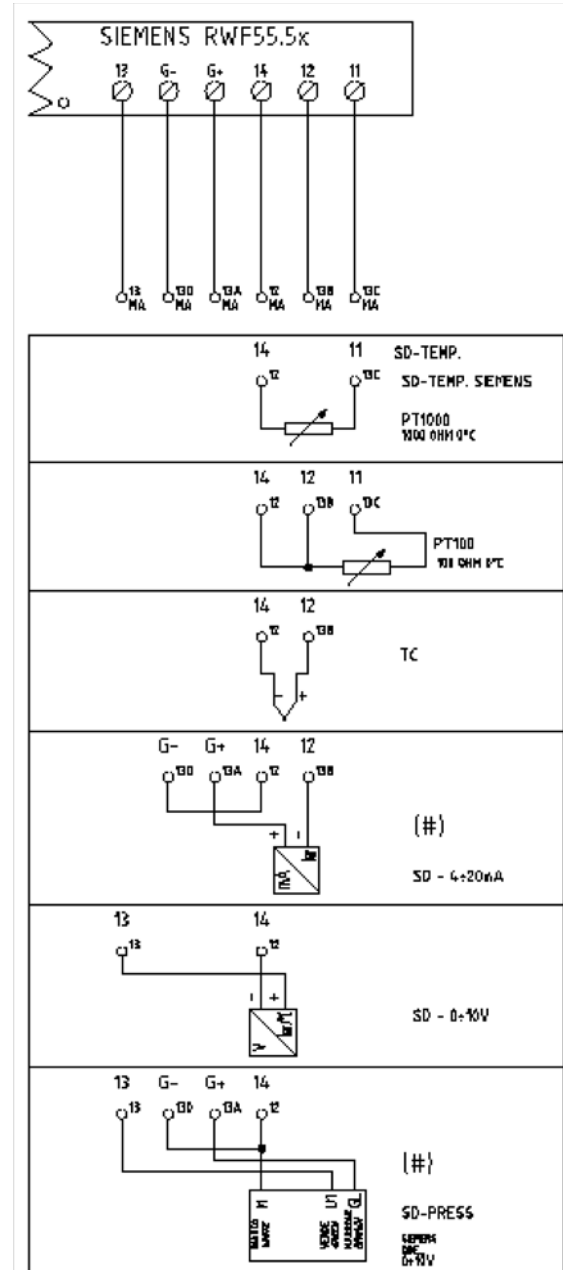
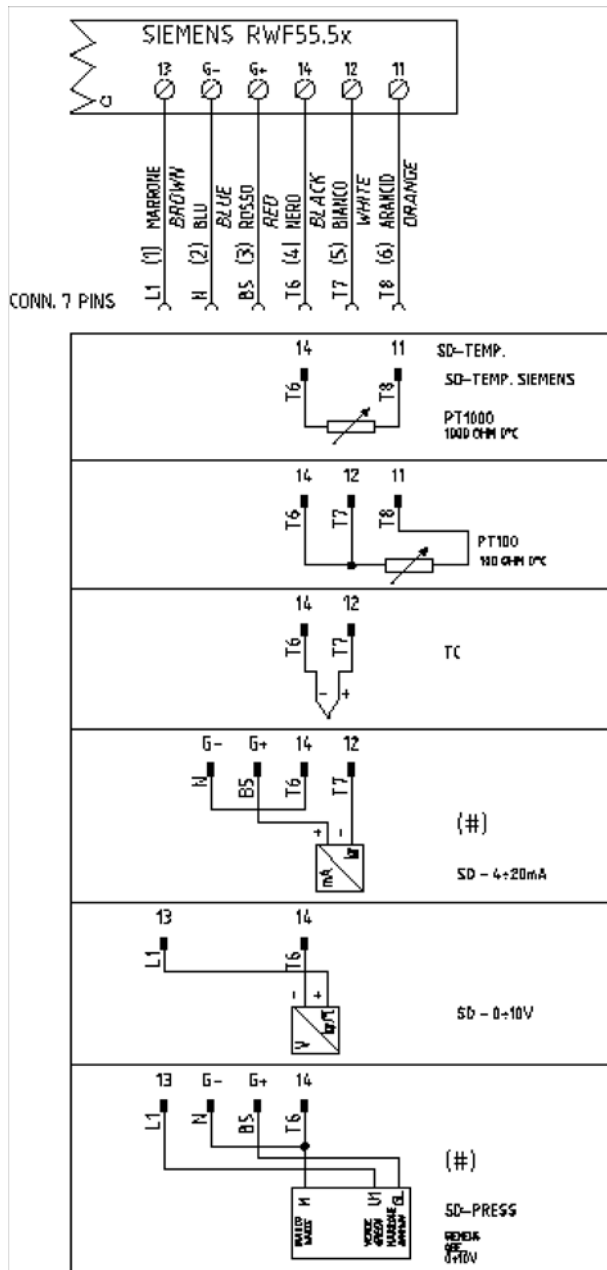

Correspondences bornes entre RWF55.5x y RWF40.0x0Matches terminals between RWF55.5x and RWF40.0x0

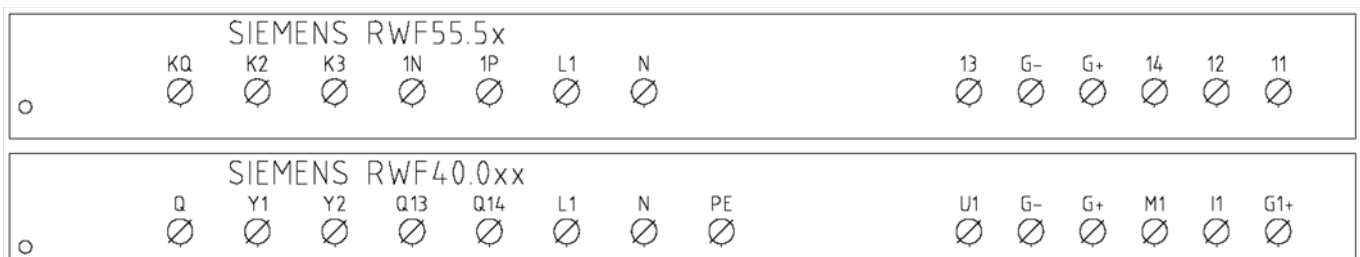

Parameters summarising for RWF55.xx :

Navigation menu	ConF					ConF			PArA						Opr
	Inp					Cntr		diSP							Opr
	Inp1														
	SEn1	OFF1	SCL	SCH	Unit	SPL	SPH	dECP	Pb. 1	dt	rt	tt	HYS1 (*)	HYS3 (*)	SP1 (*)
Siemens QAE2120...	6	0	needless	needless	1	30	95	1	10	80	350	(#)	-5	5	80 °C
Siemens QAM2120..	6	0	needless	needless	1	0	80	1	10	80	350	(#)	-2,5	2,5	40°C
Pt1000 (130°C max.)	4	0	needless	needless	1	30	95	1	10	80	350	(#)	-5	5	80°C
Pt1000 (350°C max.)	4	0	needless	needless	1	0	350	1	10	80	350	(#)	-5	10	80°C
Pt100 (130°C max.)	1	0	needless	needless	1	0	95	1	10	80	350	(#)	-5	5	80°C
Pt100 (350°C max)	1	0	needless	needless	1	0	350	1	10	80	350	(#)	-5	10	80°C
Probe4+20mA / 0+1,6bar	16	0	0	160	needless	0	160	0	5	20	80	(#)	0	20	100 kPa
Probe4+20mA / 0+3bar	16	0	0	300	needless	0	300	0	5	20	80	(#)	0	20	200 kPa
Probe 4+20mA / 0+10bar	16	0	0	1000	needless	0	1000	0	5	20	80	(#)	0	50	600 kPa
Probe 4+20mA / 0+16bar	16	0	0	1600	needless	0	1600	0	5	20	80	(#)	0	80	600 kPa
Probe 4+20mA / 0+25bar	16	0	0	2500	needless	0	2500	0	5	20	80	(#)	0	125	600 kPa
Probe 4+20mA / 0+40bar	16	0	0	4000	needless	0	4000	0	5	20	80	(#)	0	200	600 kPa
Probe 4+20mA / 0+60PSI	16	0	0	600	needless	0	600	0	5	20	80	(#)	0	30	300 (30PSI)
Probe4+20mA / 0+200PSI	16	0	0	2000	needless	0	2000	0	5	20	80	(#)	0	75	600 (60PSI)
Probe4+20mA / 0+300PSI	16	0	0	3000	needless	0	3000	0	5	20	80	(#)	0	120	600 (60PSI)
Siemens QBE2002 P4	17	0	0	400	needless	0	400	0	5	20	80	(#)	0	20	200 kPa
Siemens QBE2002 P10	17	0	0	1000	needless	0	1000	0	5	20	80	(#)	0	50	600 kPa
Siemens QBE2002 P16	17	0	0	1600	needless	0	1600	0	5	20	80	(#)	0	80	600 kPa
Siemens QBE2002 P25	17	0	0	2500	needless	0	2500	0	5	20	80	(#)	0	125	600 kPa
Siemens QBE2002 P40	17	0	0	4000	needless	0	4000	0	5	20	80	(#)	0	200	600 kPa
Signal 0+10V	17	0	needless	needless	needless	needless	needless	needless	5	20	80	(#)			
Signal 4+20mA	16	0	needless	needless	needless	needless	needless	needless	5	20	80	(#)			

NOTE:

(#) tt – servo control run time

SQL33 ; STM30; SQM10; SQM40; SQM50; SQM54 = 30 (secondi) - STA12B3.41; SQN30.251; SQN72.4A4A20 = 12 (secondi)

(*)These values are factory set - values must be set during operation at the plant based on the real working temperature/pressure value.

WARNING :

With pressure probes in bar the parameters SP1, SCH, SCL, HYS1, HYS3 must be set and displayed in kPa (kilo Pascal); 1bar = 100,000Pa = 100kPa.

With pressure probes in PSI the parameters SP1, SCH, SCL, HYS1, HYS3 must be set and displayed in PSI x10 (example: 150PSI > I display 1500).

APPENDIX: PROBES CONNECTION

To assure the utmost comfort, the control system needs reliable information, which can be obtained provided the sensors have been installed correctly. Sensors measure and transmit all variations encountered at their location.

Measurement is taken based on design features (time constant) and according to specific operating conditions. With wiring run in raceways, the sheath (or pipe) containing the wires must be plugged at the sensor's terminal board so that currents of air cannot affect the sensor's measurements.

Ambient probes (or ambient thermostats)

Installation

The sensors (or room thermostats) must be located in reference rooms in a position where they can take real temperature measurements without being affected by foreign factors.

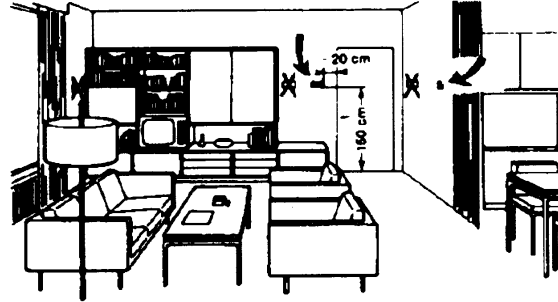
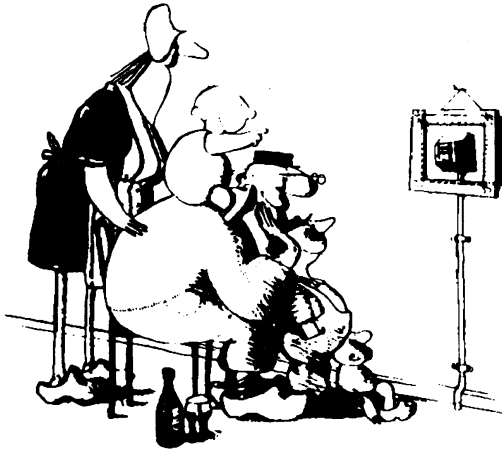

Outside probes (weather) Installation

In heating or air-conditioning systems featuring adjustment in response to outside temperature, the sensor's positioning is of paramount importance.

It's good to be admired ...even better to be effective

Heating systems: the room sensor must not be installed in rooms with heating units complete with thermostatic valves. Avoid all sources of heat foreign to the system.

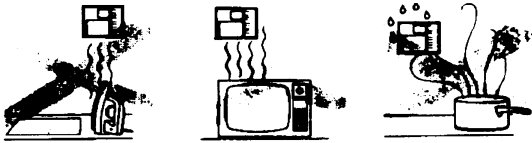

General rule: en on the outer wall of the building where the living rooms are, never on the south-facing wall or in a position where they will be affected by morning sun. If in any doubt, place them on the north or north-east façade.

Positions to be avoided

Location

On an inner wall on the other side of the room to heating units height above floor 1.5 m, at least 1.5 m away from external sources of heat (or cold).

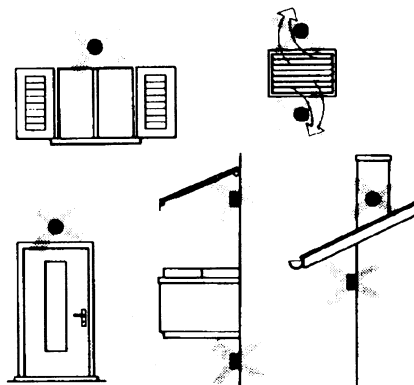
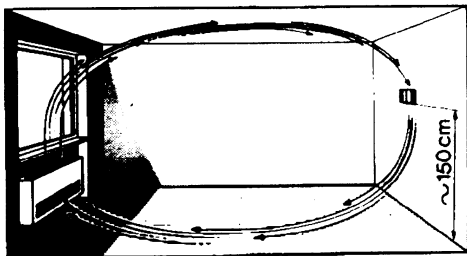

Installation position to be avoided

near shelving or alcoves and recesses, near doors or windows, inside outer walls exposed to solar radiation or currents of cold air, on inner walls with heating system pipes, domestic hot water pipes, or cooling system pipes running through them.

Avoid installing near windows, vents, outside the boiler room, on chimney breasts or where they are protected by balconies, cantilever roofs .

The sensor must not be painted (measurement error) .

Duct or pipe sensors

Installing temperature sensors

For measuring outlet air:

"after delivery fan or

"after coil to be controlled, at a distance of at least 0,5 m

For measuring room temperature:

"before return air intake fan and near room's return airintake.

For measuring saturation temperature: after mist eliminator.

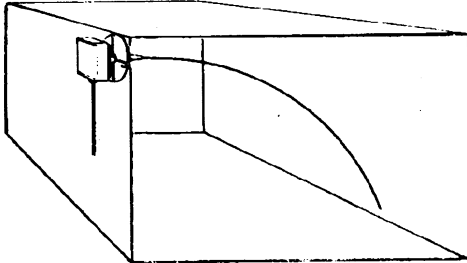

Bend 0.4m sensor by hand (never use tools) as illustrated .

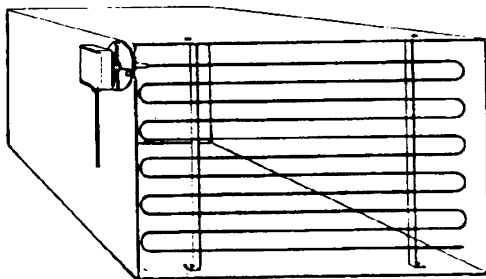

Use whole cross-section of duct, min. distance from walls 50 mm, radius of curvature 10 mm for 2m or 6m sensors

Installing combined humidity sensors

As max. humidity limit sensor on outlet (steam humidifiers) .

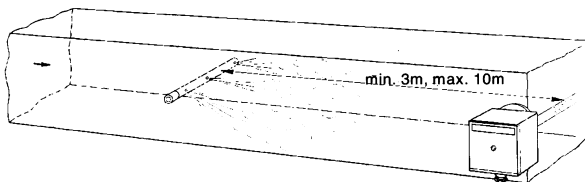

Installing pressure sensors

A - installation on ducts carrying fluids at max. temperature 80°C

B - installation on ducts at temperature over 80°C and for refrigerants

C - installation on ducts at high temperatures :

· "increase length of siphon

"place sensor at side to prevent it being hit by hot air coming from the pipe.

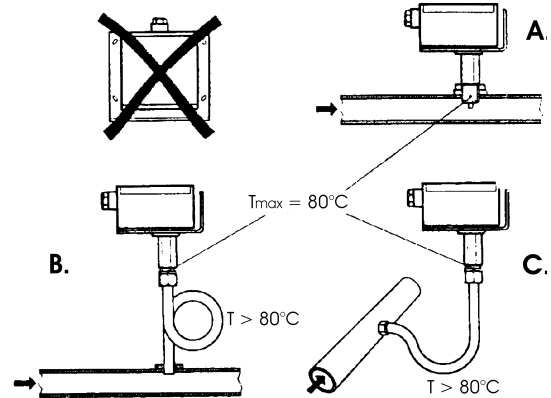

Installing differential pressure sensors for water

Installation with casing facing down not allowed.

With temperature over 80°C, siphons are needed.

To avoid damaging the sensor, you must comply with the following instructions :

when installing: make sure pressure difference is not greater than the value permitted by the sensor

when there are high static pressures, make sure you insert shutoff valves A-B-C.

Putting into operation

Start disable

1=open C1=open C

2=open A2=close B

3=open B3=close A

4= close C

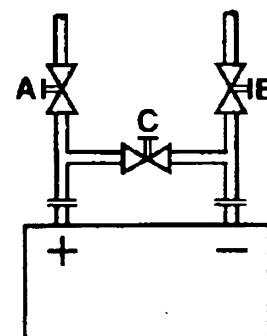

Immersion or strap-on sensors

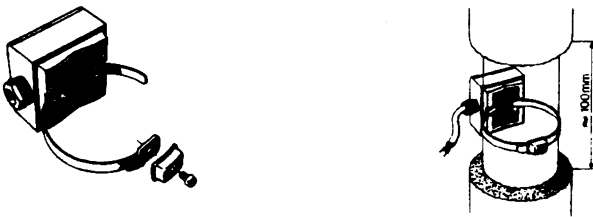
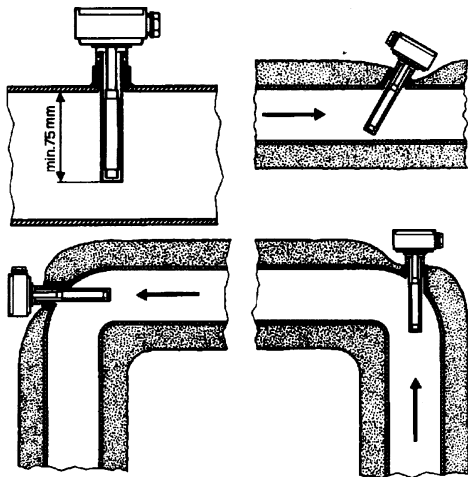

Placing the probes (QAD22.../QAE21.../QAP21.../RCA...)

With pumps on outlet

with 3 ways valves / with 4 ways valves



Panel system / burner control

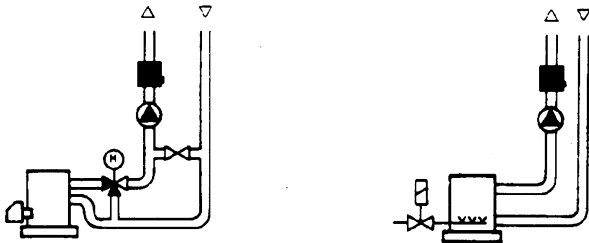

With pumps on return

with 3 ways valves / with 4 ways valves



Immersion probes installation

Sensors must be installed on the stretch of pipe in which fluid circulates all the time.

The rigid stem (sensing element doing the measuring) must be inserted by at least 75mm and must face the direction of flow.

Recommended locations: on a bend or on a straight stretch of pipe but tilted by 45° and against the flow of fluid.

Protect them to prevent water from infiltrating (dripping gates, condensation from pipes etc.) .

Installing QAD2.. strap-on sensors

Make sure fluid is circulating in the chosen location.

Eliminate insulation and paintwork (including rust inhibitor) on a min. 100mm length of pipe.

Sensors come with straps for pipes up to 100 mm in diameter .

Strap-on or immersion sensors?

QAD2.. strap-on sensors

Advantages :

- 10 sec. time constant
- Installed with system running (no plumbing work)
- Installation can be changed easily if it proves incorrect

ΠLimits:

- Suitable for pipe diameters max. 100 mm
- Can be affected by currents of air etc.

QAE2... immersion sensors

Advantages:

- Measure "mean" fluid temperature
- No external influence on measurement such as: currents of air, nearby pipes etc.

Limits:

- Time constant with sheath: 20 sec.
- Hard to change installation position if it proves incorrect

Installing differential pressure probes for air

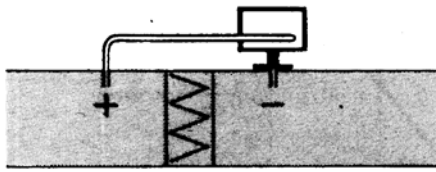

A - Control a filter (clogging)

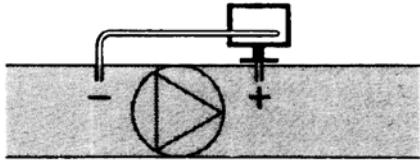

B - Control a fan (upstream/downstream)

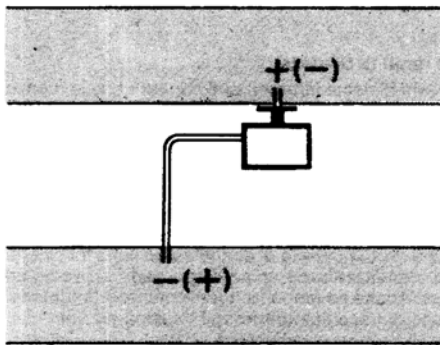

C - Measurement of difference in pressure between two ducts

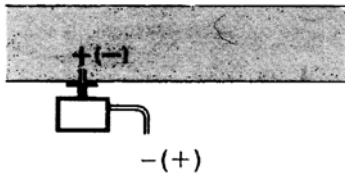

D - Measurement of difference in pressure between two rooms or of inside of duct and outside

Basic principles

Measuring static pressure (i.e. pressure exerted by air on pipe walls)

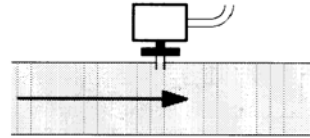

Measuring dynamic pressure

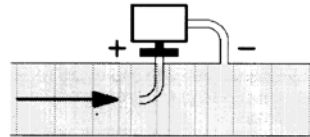

$$P_d = \frac{\gamma v^2}{2g}$$

Legend

- y Kg/m³, specific weight of air
- q m/s, air speed
- g 9.81 m/s² gravity acceleration
- P_d mm C.A., dynamic pressure

Measuring total pressure

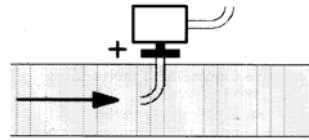

Note: Specifications and data subject to change. Errors and omissions excepted.

VERSIONE MONOSTADIO "TN"
"TN" SINGLE-STAGE VERSION

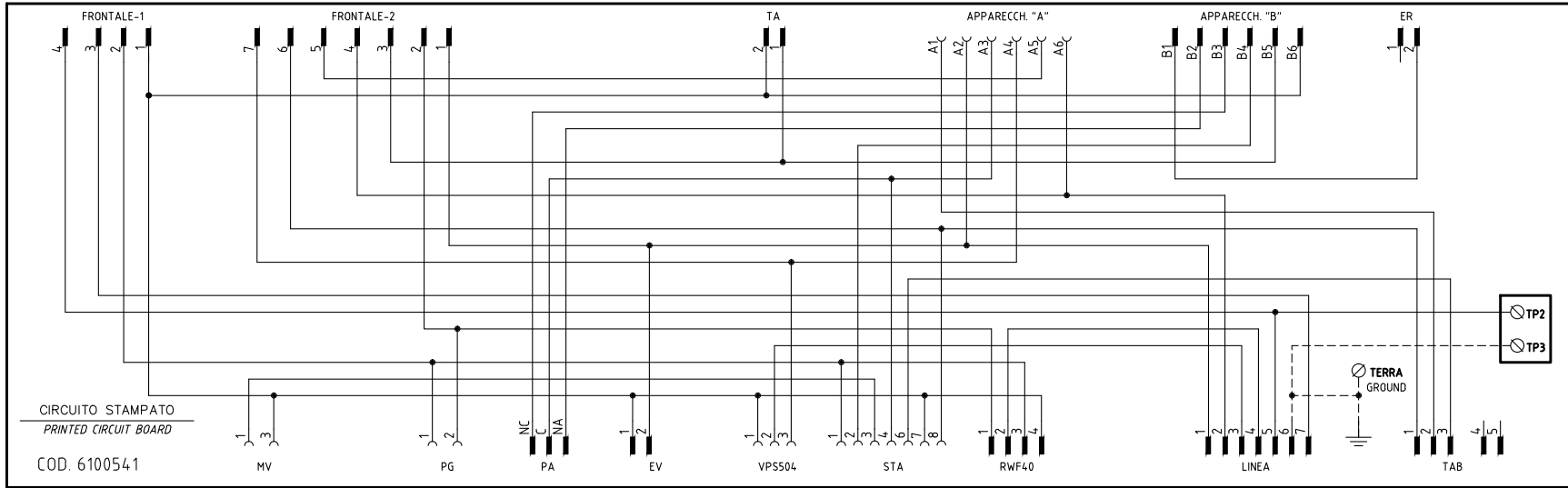
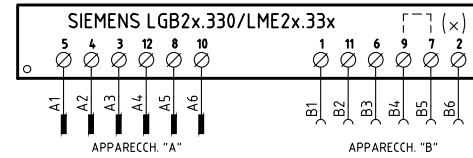
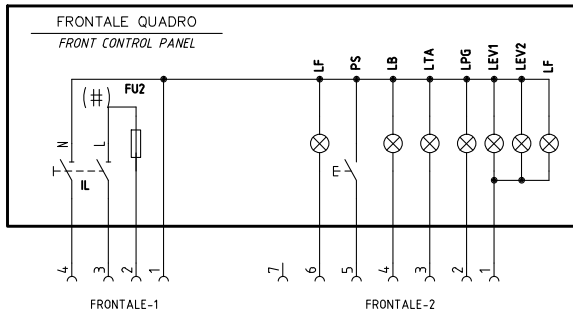

COD. 6100541

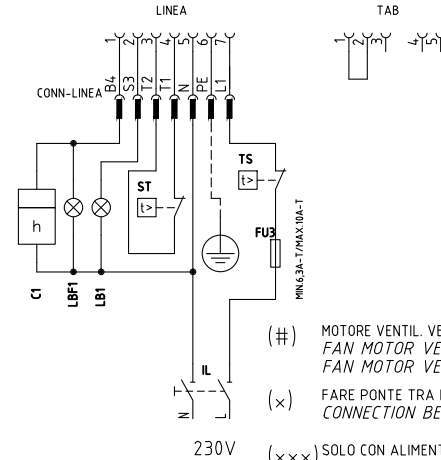
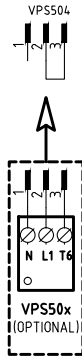
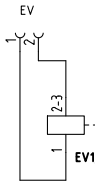
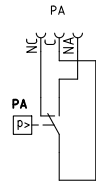
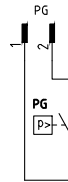
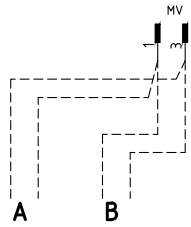

- (#) MOTORE VENTIL. VERSIONE [A], FU2 = 6,3A F; MOTORE VENTIL. VERSIONE [B], FU2 = 10A F
FAN MOTOR VERSION [A], FU2 = 6,3 A F;
FAN MOTOR VERSION [B], FU2 = 10 A F
- (x) FARE PONTE TRA I MORSETTI 7 E 9 SOLO CON LGB21.330
CONNECTION BETWEEN TERMINALS 7 AND 9 WITH LGB21.330 ONLY
- (x x x) SOLO CON ALIMENTAZIONE ELETTRICA SENZA NEUTRO
WITH ELECTRIC SUPPLY WITHOUT NEUTRAL VERSION ONLY

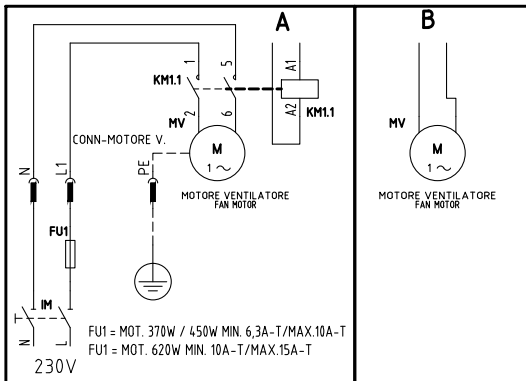

Impianto
TIPI/TYPES NG(X)350/400/550 - LG(X)350/400/550
MODELLI/MODELS x-.TN(PR)(MD).x.xx.A.x.xx

Descrizione
VERSIONE CON CIRCUITO STAMPATO
WITH PRINTED CIRCUIT VERSION

Ordine
Commissa
Esecutore
U. PINTON

Data Controllato
07/08/2014

Controllato
E. CAVALLI

Data	19/10/2010	PREC.	FOGLIO
Revisione	05	/	1
Dis. N.	18 - 0163	SEGUE	TOTALE
		2	5

05	AGGIUNTO/ADDED "KVB" ASCON	07/08/14	U. PINTON	FIRME
04	AGGIUNTO/ADDED "600V"	19/06/12	U. PINTON	
03	AGGIUNTO/ADDED "RWF502x"	20/01/12	U. PINTON	
02	MOTOR MODIFY	19/10/10	U. PINTON	
01	AGGIUNTO / ADDED SGM72...	22/05/09	U. PINTON	
REV.	MODIFICA	DATA		

VERSIONE ALTA-BASSA FIAMMA "AB" / PROGRESSIVO "PR"
 "AB" HIGH-LOW / "PR" PROGRESSIVE VERSION

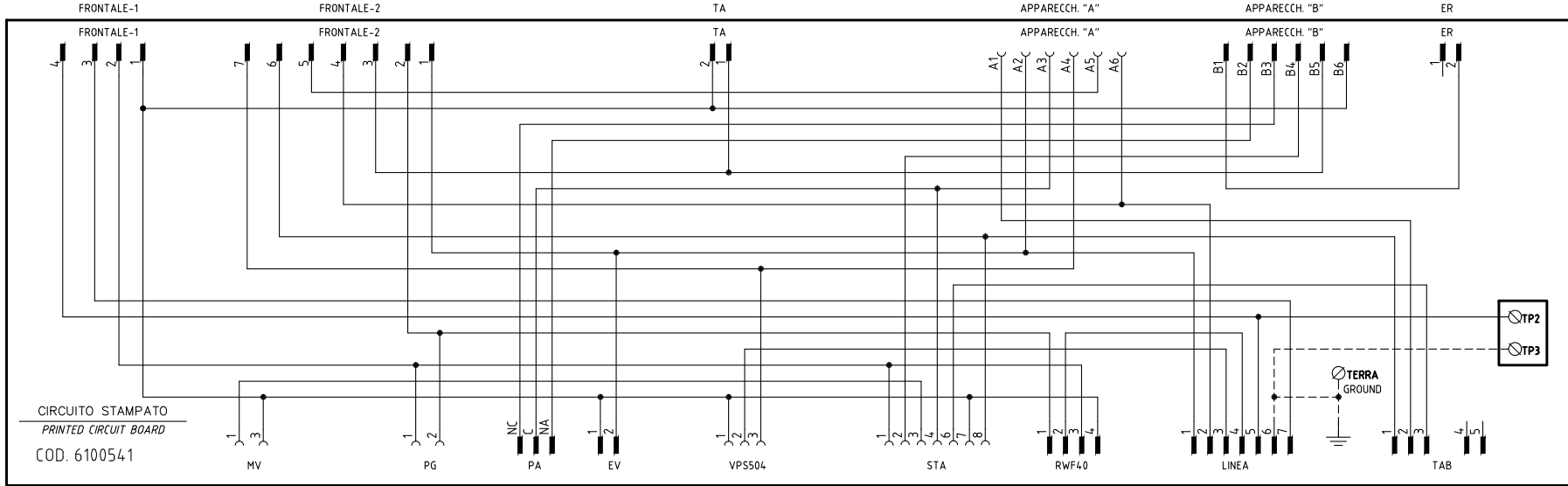
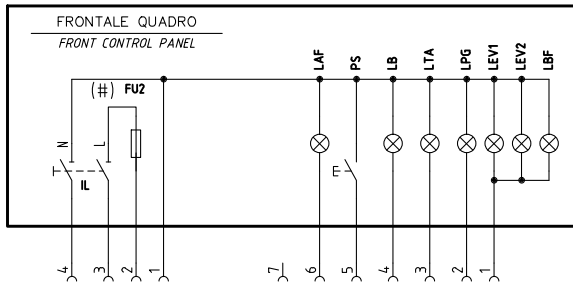

SERVOCOMANDO SERRANDA ARIA
 AIR DAMPER ACTUATOR
 STA13B0.36/83N30L

I ALTA FIAMMA
 HIGH FLAME
 II SOSTA
 STAND-BY
 III BASSA FIAMMA
 LOW FLAME
 IV NON USATA
 NOT USED

SERVOCOMANDO SERRANDA ARIA
 AIR DAMPER ACTUATOR
 SIEMENS SQNT2.xA4.A20

I (ROSSO) ALTA FIAMMA
 HIGH FLAME
 II (BLU) SOSTA
 STAND-BY
 III (ARANCIO) BASSA FIAMMA
 LOW FLAME
 IV (NERO) NON USATA
 NOT USED

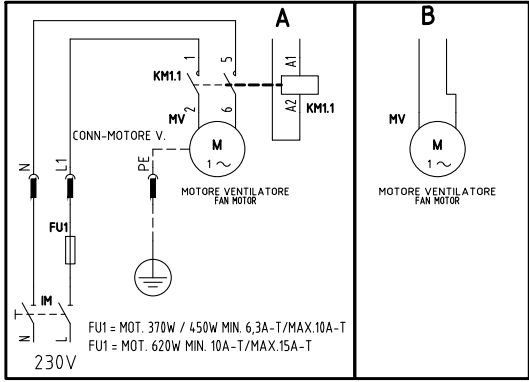
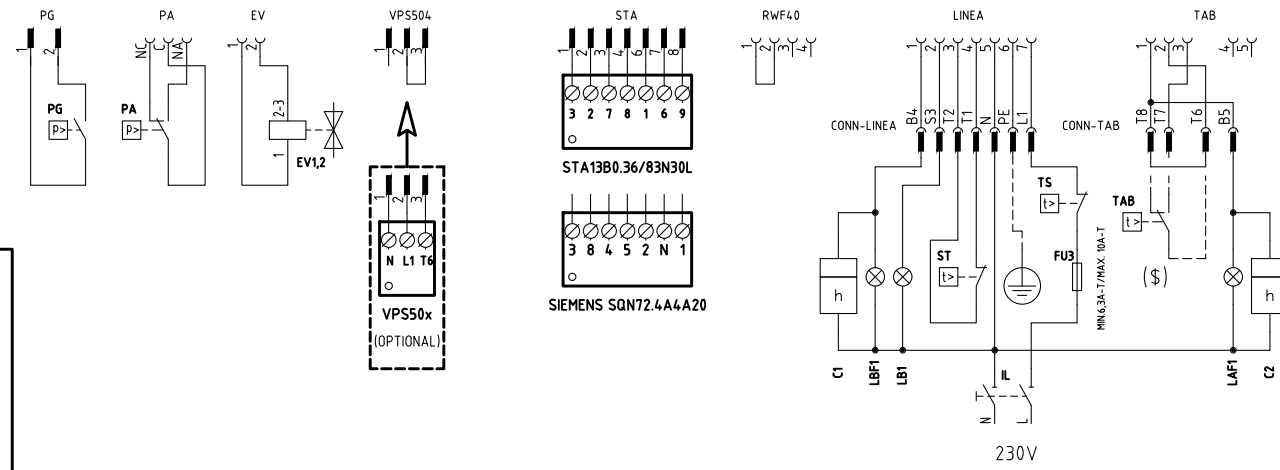
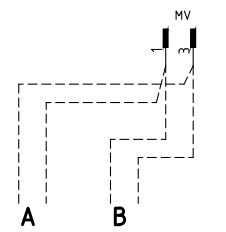

(#) MOTORE VENTIL. VERSIONE [A], FU2 = 6,3A F; MOTORE VENTIL. VERSIONE [B], FU2 = 10A F
 FAN MOTOR VERSION [A], FU2 = 6,3 A F;
 FAN MOTOR VERSION [B], FU2 = 10 A F

(x x x) SOLO CON ALIMENTAZIONE ELETTRICA SENZA NEUTRO
 WITH ELECTRIC SUPPLY WITHOUT NEUTRAL VERSION ONLY

(\$) SE USATO "TAB", TOGLIERE IL PONTE TRA I MORSETTI T6-T8
 IF USED "TAB", REMOVE THE BRIDGE BETWEEN TERMINALS T6-T8

Data	19/10/2010	PREC.	FOGLIO
Revisione	05	1	2
Dis. N.	18 - 0163	SEGUE	TOTALE
		3	5

VERSIONE MODULANTE "MD"
"MD" MODULATING VERSION

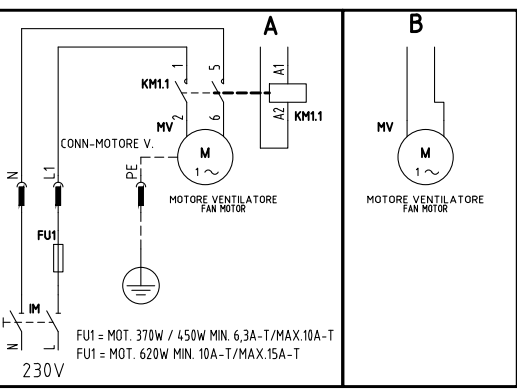
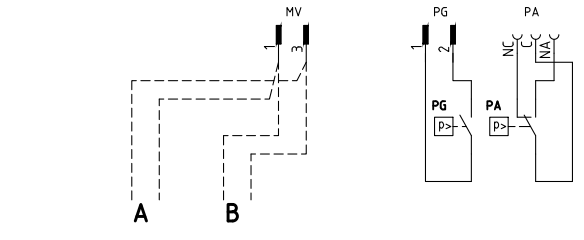
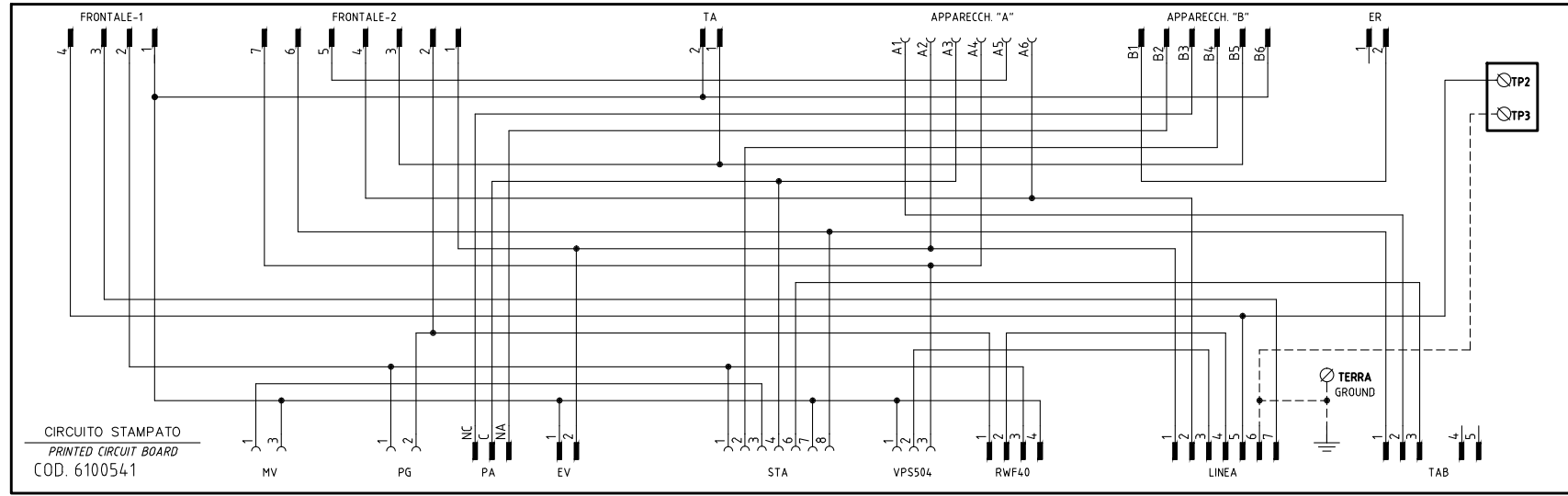
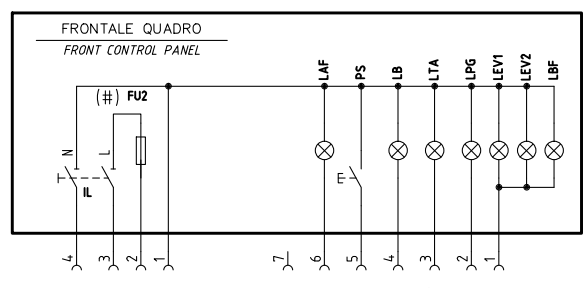

SERVOCOMANDO SERRANDA ARIA
AIR DAMPER ACTUATOR
STA13B0.36/83N30L

I ALTA FIAMMA HIGH FLAME
II SOSTA STAND-BY
III BASSA FIAMMA LOW FLAME
IV NON USATA NOT USED

SERVOCOMANDO SERRANDA ARIA
AIR DAMPER ACTUATOR
SIEMENS SQN72.xA4.A20

I (ROSSO) ALTA FIAMMA HIGH FLAME
II (BLU) SOSTA STAND-BY
III (ARANCIO) BASSA FIAMMA LOW FLAME
IV (NERO) NON USATA NOT USED

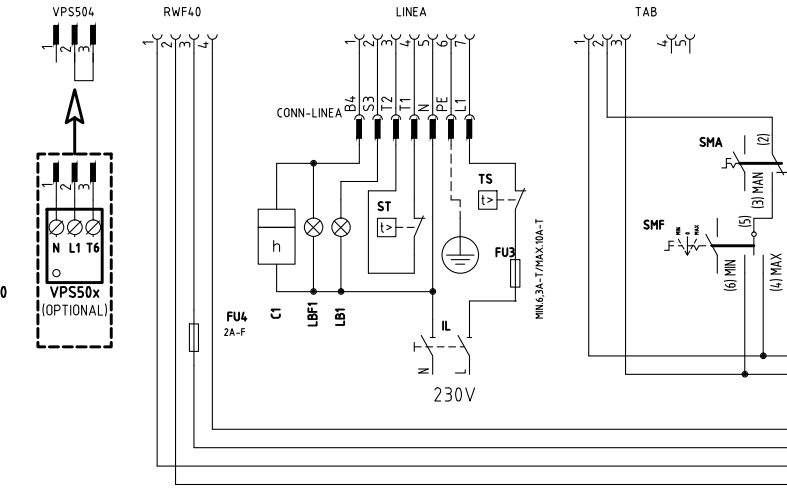
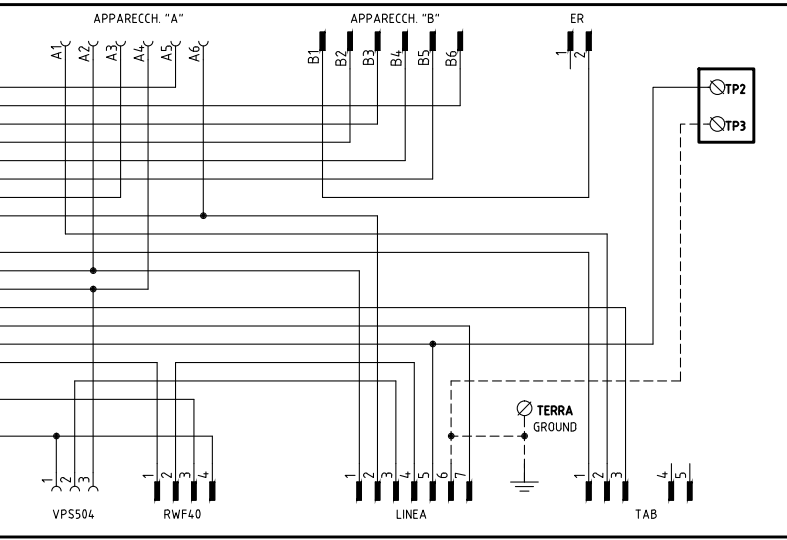
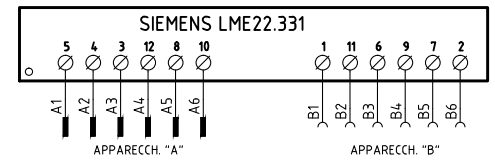

(#) MOTORE VENTIL. VERSIONE [A], FU2 = 6,3A F; MOTORE VENTIL. VERSIONE [B], FU2 = 10A F
FAN MOTOR VERSION [A], FU2= 6,3 A F;
FAN MOTOR VERSION [B], FU2= 10 A F

(x x x) SOLO CON ALIMENTAZIONE ELETTRICA SENZA NEUTRO
WITH ELECTRIC SUPPLY WITHOUT NEUTRAL VERSION ONLY

ASCON KM3 HCRMMD													
14	12	7	8	10	9	11-13	4	1	2	3			
⊗	⊗	⊗	⊗	⊗	⊗	⊗	⊗	⊗	⊗	⊗			

600V RRR0-1-T73 (S)												
20	6	21	22	23	24	19-5	4	3	2	1		
⊗	⊗	⊗	⊗	⊗	⊗	⊗	⊗	⊗	⊗	⊗		

SIEMENS RWF50.2x												
K2	K3	IN	1P	L1	N	KQ	G-	G+	13	12	11	
⊗	⊗	⊗	⊗	⊗	⊗	⊗	⊗	⊗	⊗	⊗	⊗	

SIEMENS RWF55.5x													
K2	K3	IN	1P	L1	N	KQ	TE	13	G-	G+	14	12	11
⊗	⊗	⊗	⊗	⊗	⊗	⊗	⊗	⊗	⊗	⊗	⊗	⊗	⊗

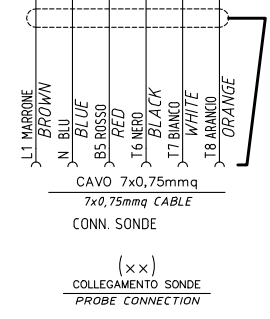

Data	19/10/2010	PREC.	FOGLIO
Revisione	05	2	3
Dis. N.	18 - 0163	SEQUE	TOTALE
		4	5

(xx)
 ATTENZIONE COLLEGAMENTO SONDE CON CONNETTORE 7 POLI
 WARNING PROBE CONNECTION WITH 7 PINS CONNECTOR

KM3 HCRMMD

600V RRR0-1-T73

RWF55.5x

RWF50.2x

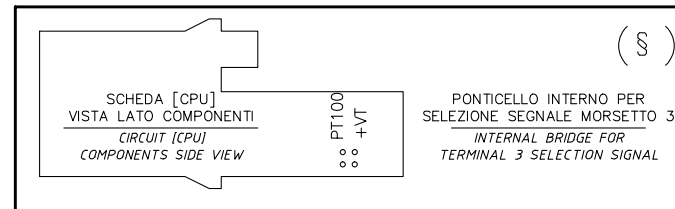
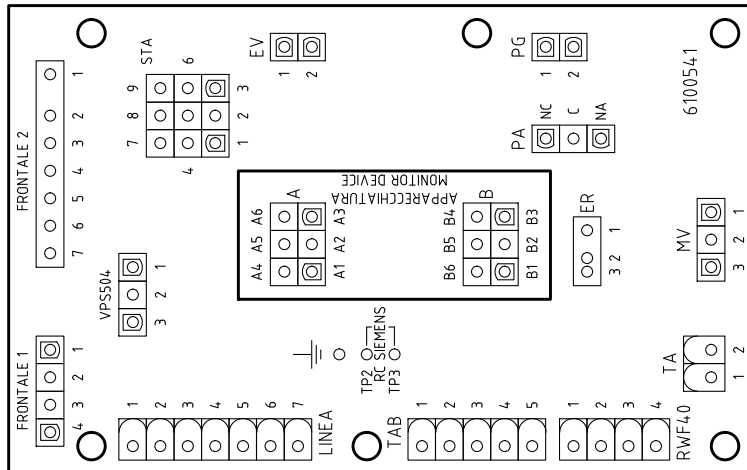
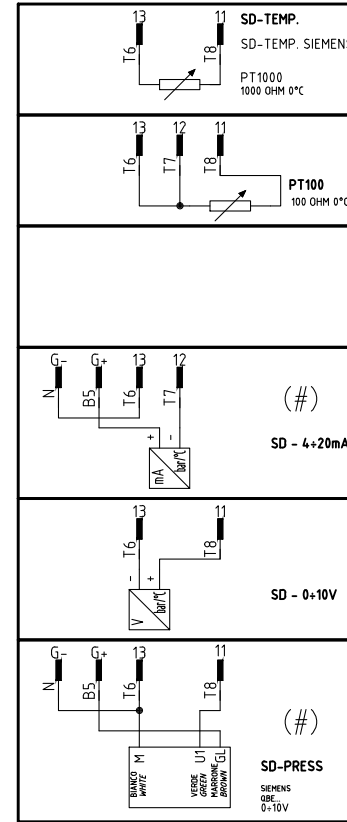
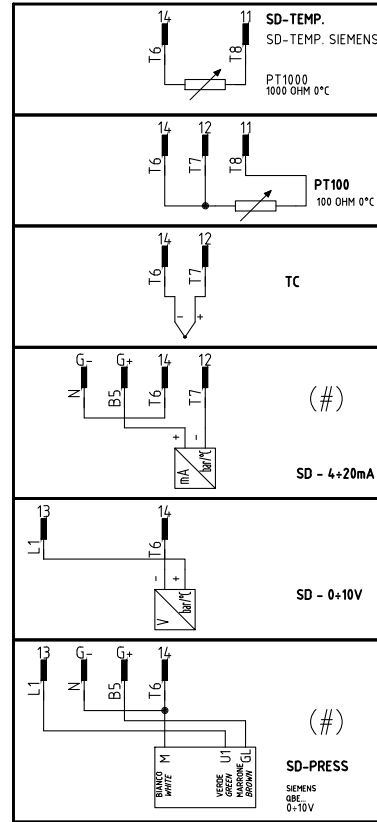
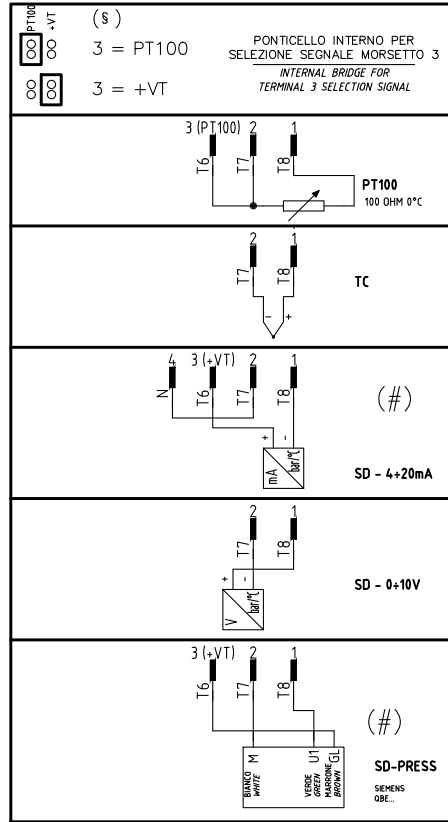
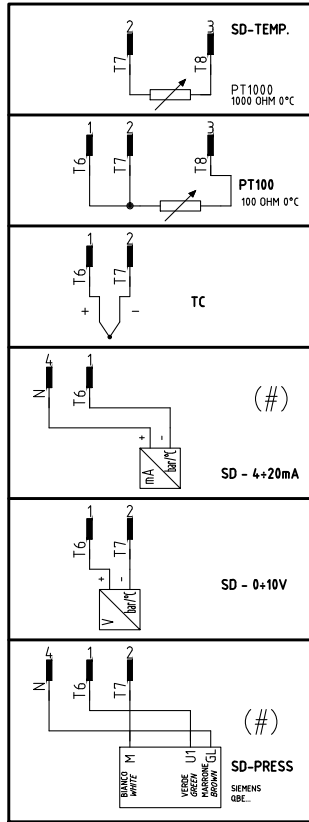

Data	19/10/2010	PREC.	FOGLIO
Revisione	05	3	4
Dis. N.	18 - 0163	SEGUE	TOTALE
		5	5

Sigla/Item	Funzione	Function
600V RRR0-1-T73	REGOLATORE MODULANTE (ALTERNATIVO)	BURNER MODULATOR (ALTERNATIVE)
C1	CONTAORE BASSA FIAMMA	LOW FLAME TIME COUNTER
C2	CONTAORE ALTA FIAMMA	HIGH FLAME TIME COUNTER
ER	ELETTRODO RILEVAZIONE FIAMMA	FLAME DETECTION ELECTRODE
EV1,2	ELETTROVALVOLE GAS (O GRUPPO VALVOLE)	GAS ELECTRO-VALVES (OR VALVES GROUP)
FU1	FUSIBILE LINEA MOTORE VENTILATORE	FAN MOTOR LINE FUSE
FU2	FUSIBILE DI LINEA	LINE FUSE
FU3	FUSIBILE DI LINEA	LINE FUSE
FU4	FUSIBILE AUSILIARIO	AUXILIARY FUSE
IL	INTERRUTTORE LINEA BRUCIATORE	BURNER LINE SWITCH
IM	INTERRUTTORE LINEA MOTORE VENTILATORE	FAN MOTOR LINE SWITCH
KM1.1	CONTATTORE MOTORE VENTILATORE	FAN MOTOR CONTACTOR
KM3 HCRMMD	REGOLATORE MODULANTE (ALTERNATIVO)	BURNER MODULATOR (ALTERNATIVE)
LAF	LAMPADA SEGNALAZIONE ALTA FIAMMA BRUCIATORE	BURNER IN HIGH FLAME INDICATOR LIGHT
LAF1	LAMPADA SEGNALAZIONE ALTA FIAMMA BRUCIATORE	BURNER IN HIGH FLAME INDICATOR LIGHT
LB	LAMPADA SEGNALAZIONE BLOCCO BRUCIATORE	INDICATOR LIGHT FOR BURNER LOCK-OUT
LB1	LAMPADA SEGNALAZIONE BLOCCO BRUCIATORE	INDICATOR LIGHT FOR BURNER LOCK-OUT
LBF	LAMPADA SEGNALAZIONE BASSA FIAMMA BRUCIATORE	BURNER IN LOW FLAME INDICATOR LIGHT
LBF1	LAMPADA SEGNALAZIONE BASSA FIAMMA BRUCIATORE	BURNER IN LOW FLAME INDICATOR LIGHT
LEV1	LAMPADA SEGNALAZIONE APERTURA [EV1]	INDICATOR LIGHT FOR OPENING OF ELECTRO-VALVE [EV1]
LEV2	LAMPADA SEGNALAZIONE APERTURA [EV2]	INDICATOR LIGHT FOR OPENING OF ELECTRO-VALVE [EV2]
LF	LAMPADA SEGNALAZIONE FUNZIONAMENTO BRUCIATORE	INDICATOR LIGHT BURNER OPERATION
LPG	LAMPADA SEGNALAZIONE PRESENZA GAS IN RETE	INDICATOR LIGHT FOR PRESENCE OF GAS IN THE NETWORK
LTA	LAMPADA SEGNALAZIONE TRASFORMATORE DI ACCENSIONE	IGNITION TRANSFORMER INDICATOR LIGHT
MV	MOTORE VENTILATORE	FAN MOTOR
PA	PRESSOSTATO ARIA	AIR PRESSURE SWITCH
PG	PRESSOSTATO GAS DI MINIMA PRESSIONE	MINIMUM GAS PRESSURE SWITCH
PS	PULSANTE SBLOCCO FIAMMA	FLAME UNLOCK BUTTON
PT100	SONDA DI TEMPERATURA	TEMPERATURE PROBE
RC	CIRCUITO RC	RC CIRCUIT
SD-PRESS	SONDA DI PRESSIONE	PRESSURE PROBE
SD-TEMP.	SONDA DI TEMPERATURA	TEMPERATURE PROBE
SD - 0÷10V	TRASDUTTORE USCITA IN TENSIONE	TRANSDUCER VOLTAGE OUTPUT
SD - 4÷20mA	TRASDUTTORE USCITA IN CORRENTE	TRANSDUCER CURRENT OUTPUT
SIEMENS LGB2x.330/LME2x.33x	APPARECCHIATURA CONTROLLO FIAMMA	CONTROL BOX
SIEMENS LME22.331	APPARECCHIATURA CONTROLLO FIAMMA	CONTROL BOX
SIEMENS RWF50.2x	REGOLATORE MODULANTE	BURNER MODULATOR
SIEMENS RWF55.5x	REGOLATORE MODULANTE (ALTERNATIVO)	BURNER MODULATOR (ALTERNATIVE)
SIEMENS SQN72.4A4A20	SERVOCOMANDO SERRANDA ARIA (ALTERNATIVO)	AIR DAMPER ACTUATOR (ALTERNATIVE)
SMA	SELETTORE MANUALE/AUTOMATICO	MANUAL/AUTOMATIC SWITCH
SMF	SELETTORE MANUALE FUNZIONAMENTO MIN-0-MAX	MIN-0-MAX MANUAL OPERATION SWITCH
ST	SERIE TERMOSTATI/PRESSOSTATI	SERIES OF THERMOSTATS OR PRESSURE SWITCHES
STA13B0.36/83N30L	SERVOCOMANDO SERRANDA ARIA	AIR DAMPER ACTUATOR
TA	TRASFORMATORE DI ACCENSIONE	IGNITION TRANSFORMER
TAB	TERMOSTATO/PRESSOSTATO ALTA-BASSA FIAMMA	HIGH-LOW THERMOSTAT/PRESSURE SWITCHES
TC	TERMOCOPPIA	THERMOCOUPLE
TS	TERMOSTATO/PRESSOSTATO DI SICUREZZA	SAFETY THERMOSTAT OR PRESSURE SWITCH
VPS50x	CONTROLLO DI TENUTA VALVOLE GAS (OPTIONAL)	GAS PROVING SYSTEM (OPTIONAL)

Data	19/10/2010	PREC.	FOGLIO
Revisione	05	4	5
Dis. N.	18 - 0163	SEGUE	TOTALE
		/	5